

MACONDO WELL INCIDENT
Transocean Investigation Report
Volume I

June 2011

Table of Contents

Executive Summary	9
Chapter 1	
The Macondo Prospect and the <i>Deepwater Horizon</i>	
1.1 The Macondo Well	16
1.2 Companies Involved in Drilling the Macondo Well	17
1.3 <i>Deepwater Horizon</i> History of Operations	19
1.4 Inspections of the <i>Deepwater Horizon</i>	19
1.5 Well Operations – February – April 2010	20
Chapter 2	
Incident Chronology and Overview	
2.1 Running Production Casing	26
2.2 Converting the Float Collar	26
2.3 Cementing	27
2.4 Temporary Abandonment Plan.....	28
2.5 Displacement	29
2.6 Negative Pressure Test.....	29
2.7 Sheen Test and Final Displacement.....	30
2.8 Activation of the BOP.....	31
2.9 Initial Emergency Response, Muster, and Evacuation.....	32
Chapter 3	
Incident Analysis	
3.1 Well Design and Production Casing Cement.....	41
3.2 Temporary Abandonment.....	77
3.3 Drill Floor Activities.....	117
3.4 Blowout Preventer (BOP).....	135
3.5 Gas Dispersion and Ignition.....	173
3.6 Muster and Evacuation	197
Chapter 4	
Key Findings.....	211
Glossary	221
Appendices	Vol. II

Appendices

Vol. II – Appendices can be viewed in its entirety at www.deepwater.com.

- Appendix A.** Abbreviations and Acronyms
- Appendix B.** Macondo Casing Calculations
- Appendix C.** Testing of Cementing Float
- Appendix D.** Centralization Plan at Macondo
- Appendix E.** Review of Macondo #1 7" x 9-7/8" Production Casing Cementation
- Appendix F.** Lock-Down Sleeve Decision
- Appendix G.** Hydraulic Analysis of Macondo #252 Well Prior to Incident of April 20, 2010
- Appendix H.** BOP Modifications
- Appendix I.** BOP Maintenance History
- Appendix J.** BOP Testing
- Appendix K.** BOP Leaks
- Appendix L.** Drill Pipe in the BOP
- Appendix M.** Structural Analysis of the Macondo #252 Work String
- Appendix N.** AMF Testing
- Appendix O.** Analysis of Solenoid 103
- Appendix P.** *Deepwater Horizon* Investigation: Gas Dispersion Studies
- Appendix Q.** Possible Ignition Sources



Executive Summary

Transocean was contracted by BP Exploration & Production Inc. (BP) to provide the *Deepwater Horizon* rig and personnel to drill the Macondo well on Mississippi Canyon Block 252. Drilling started on Feb. 11, 2010, and was completed on April 9, 2010.

On April 20, 2010, the blowout of the Macondo well resulted in explosions and an uncontrollable fire onboard the *Deepwater Horizon*. Eleven people lost their lives, 17 were seriously injured, and 115 of the 126 onboard evacuated. The *Deepwater Horizon* sank 36 hours later, and the Macondo well discharged hydrocarbons into the Gulf of Mexico for nearly three months before it was contained.

Following the incident, Transocean commissioned an internal investigation team comprised of experts from relevant technical fields and specialists in accident investigation to gather, review, and analyze the facts and information surrounding the incident to determine its causes.

The investigation team began its work in the days immediately following the incident. Through an extensive investigation, the team interviewed witnesses, reviewed available information regarding well design and execution, examined well monitoring data that had been transmitted in real-time from the rig to BP and which had been available to BP's operating partners and Halliburton, consulted industry and technical experts, and evaluated available physical evidence and third-party testing reports.

The loss of evidence with the rig and the unavailability of certain witnesses limited the investigation and analysis in some areas. The team used its cumulative years of experience but did not speculate in the absence of evidence. This report does not represent the legal position of Transocean, nor does it attempt to assign legal responsibility or fault.

This report focuses on the following critical questions:

- How did reservoir fluids reach the rig floor?
 - How and why did reservoir fluids enter the well?
 - What actions did the drill crew take?
- Why did the blowout preventer (BOP) not stop the flow of reservoir fluids?
- How did reservoir fluids ignite?
 - What occurred after the reservoir fluids reached the rig?
 - How did personnel onboard evacuate the rig?

This report is the culmination of the investigation. These conclusions are the result of the investigation team's analysis of information available to date. The investigation team is aware of investigations conducted by other companies and is aware of, but did not review, additional testimony that is being developed in multi-district litigation proceedings.

The data relied upon by the investigation team is identified in footnotes, endnotes, and the appendices to this report.

Overview of Findings

The Macondo incident was the result of a succession of interrelated well design, construction, and temporary abandonment decisions that compromised the integrity of the well and compounded the risk of its failure. The decisions, many made by the operator, BP, in the two weeks leading up to the incident, were driven by BP's knowledge that the geological window for safe drilling was becoming increasingly narrow. Specifically, BP was concerned that downhole pressure — whether exerted by heavy drilling mud used to maintain well control or by pumping cement to seal the well — would exceed the fracture gradient and result in losses to the formation. While these and other contributing factors were complex, the Transocean investigation team traced them to four overarching issues:

Risk Management and Communication

BP was responsible for developing detailed plans as to where and how the Macondo well was to be drilled, cased, cemented, and completed, and for obtaining approval of those plans from the Minerals Management Service (MMS). It retained full authority over drilling operations, casing and cementing, and temporary abandonment procedures, including approval of all work to be performed by contractors and subcontractors. Evidence indicates that BP failed to properly assess, manage, and communicate risk. For example, BP did not properly communicate to the drill crew the lack of testing on the cement or the uncertainty surrounding critical tests and procedures used to confirm the integrity of the barriers intended to inhibit the flow of hydrocarbons. It is the view of the investigation team that on April 20, 2010, the actions of the drill crew reflected its understanding that the well had been properly cemented and successfully tested.

Well Design and Construction

The precipitating cause of the Macondo incident was the failure of the downhole cement to isolate the reservoir, which allowed hydrocarbons to enter the wellbore.

BP's original well plan called for use of a long-string production casing. While drilling the Macondo well, BP experienced both lost circulation events and kicks and stopped short of its planned total depth because of an increasingly narrow margin between the pore pressure and fracture gradients. In the context of these delicate conditions, cementing a long-string casing further increased the risk of exceeding the fracture gradient. Rather than adjusting the production casing design, BP adopted a technically complex nitrogen foam cement program. The resulting cement program was of minimal quantity, left little margin for error, and was not tested adequately before or after the cementing operation. Further, the integrity of the cement may have been compromised by contamination, instability, and an inadequate number of devices used to center the casing in the wellbore.

Risk Assessment and Process Safety

Based on the evidence, the investigation team determined that during various operations at Macondo, BP failed to properly require or confirm critical cement tests or conduct adequate risk assessments.

Halliburton and BP did not adequately test the cement slurry and program despite the inherent complexity, difficulties, and risks associated with the design and implementation of the program and some test data showing that the cement would not be stable.

BP also failed to assess the risk of the temporary abandonment procedure used at Macondo. BP generated at least five different temporary abandonment plans for the Macondo well between April 12, 2010, and April 20, 2010. After this series of last-minute alterations, BP proceeded with a temporary abandonment plan that created risk and did not have the required approval by the MMS. Most significantly, the final plan called for a substantial and unnecessary displacement of drilling mud, thus underbalancing the well before setting a second surface cement plug and conducting a negative pressure test.

It does not appear that BP used risk assessment procedures or prepared Management of Change documents for these decisions, or otherwise addressed these risks and the potential adverse effects on personnel and process safety.

Operations

The results of the critical negative pressure test were misinterpreted. The negative pressure test was inadequately set up because of displacement calculation errors, a lack of adequate fluid volume monitoring, and a lack of management of change discipline when the well monitoring arrangement was switched during the test. It is now apparent that the negative pressure test results should not have been approved, but no one involved in the negative pressure test recognized the errors. BP approved the negative pressure test results and decided to move forward with temporary abandonment.

The well became underbalanced during the final displacement, and hydrocarbons began entering the wellbore through the faulty cement barrier and a float collar that likely failed to convert. None of the individuals monitoring the well, including the Transocean drill crew, initially detected the influx.

With the benefit of hindsight and a thorough analysis of the data available to the investigation team, several indications of an influx during final displacement operations can be identified. Given the death of the members of the drill crew, and the loss of the rig and its monitoring systems, it is not known which information the drill crew was monitoring or why the drill crew did not detect a pressure anomaly until approximately 9:30 p.m. on April 20, 2010. At 9:30 p.m.,^A the drill crew acted to evaluate an anomaly. Upon detecting an influx of hydrocarbons by use of the trip tank, the drill crew undertook well-control activities that were consistent with its training including the activation of various components of the BOP. By the time actions were taken, hydrocarbons had risen above the BOP and into the riser, resulting in a massive release of gas and other fluids that overwhelmed the mud-gas separator system and released high levels of gas around the aft deck of the rig. The resulting ignition of this gas cloud was inevitable.

Forensic evidence from independent post-incident testing by Det Norske Veritas (DNV) and evaluation by the Transocean investigation team confirm that the *Deepwater Horizon* BOP was properly maintained and did operate as designed. However, it was overcome by conditions created by the extreme dynamic flow, the force of which pushed the drill pipe upward, washed or eroded the drill pipe and other rubber and metal elements, and forced the drill pipe to bow within the BOP. This prevented the BOP from completely shearing the drill pipe and sealing the well.

In the explosions and fire, the general alarm was activated, and appropriate emergency actions were taken by the *Deepwater Horizon* marine crew. The 115 personnel who survived the initial blast mustered and evacuated the rig to the offshore supply vessel *Damon B. Bankston*. Mild weather conditions and the presence of the *Bankston* at the location aided in the survival of all individuals who evacuated.

Structure of Report

The report is structured as follows:

Chapter 1 provides an overview of the Macondo prospect, the *Deepwater Horizon* drilling rig, well operations through mid-April 2010, and the companies involved.

Chapter 2 sets forth a chronological summary of the incident, highlighting the critical technical, logistical, and operational issues at Macondo.

Chapter 3 details the technical analysis and findings of the investigation team.

Chapter 4 is a summary of the overall findings by the investigation team surrounding the questions outlined above and the possible causes of the incident.

The information in this report and its appendices is available on the Transocean website at www.deepwater.com.

^A All references to time are displayed as Central Daily Time (CDT).

1 The Macondo Prospect and the *Deepwater Horizon*

1.1 The Macondo Well

In March 2008, BP Exploration & Production Inc. (BP) leased the Mississippi Canyon Block 252 (MC252) for oil and gas exploration and designated it the Macondo Prospect. BP subsequently sold interests in the prospect to Anadarko (25%) and MOEX (10%) but remained the operator and majority owner (65%).^A As operator, BP was responsible for all aspects of the design and development of the Macondo well.

BP's original Application for Permit to Drill was submitted to the Minerals Management Service (MMS) on May 13, 2009, and was approved on May 22, 2009. The plan specified using the Transocean *Marianas* to drill a well about 50 miles off the coast of Louisiana, southeast of New Orleans, in 4,992 feet (ft.) of water. The total depth of the well was planned to be 20,200 ft.

Once a drilling permit is secured, the operator designs the well in accordance with the geological conditions of the prospect. The operator's engineers and geologists determine the type and strength of the well casing, cement, well head, and other equipment, and their interpretation is critical to ensuring well integrity and preventing its failure.

The operator then selects and manages various contractors to perform specific procedures such as drilling, cementing, well monitoring, vessel support services, and other well-related tasks. The operator has the final authority and responsibility to make decisions throughout the design, cementing, testing, and final temporary abandonment phases of drilling the well.

At Macondo, BP began exploration on Oct. 6, 2009, using the Transocean *Marianas* rig.¹ On Nov. 9, 2009, Hurricane Ida damaged the *Marianas*, and drilling on Macondo was suspended following the installation and cementing of the well casing. The *Marianas* was demobilized to a shipyard for repairs, and BP applied to the MMS for permission to use the Transocean *Deepwater Horizon* rig to continue drilling. MMS approved this change on Jan. 14, 2010.

The various responsibilities of the operator and examples of tasks assigned to its respective contractors are summarized below.

Operator Responsibilities

- Conduct geological and geophysical surveys of the prospect
- Analyze proprietary geological and geophysical data when designing the well to specify the type and strength of casing, cement, centralizers, reamers, shock absorbers, well head, and other equipment and materials used to maintain well integrity
- Design and submit a detailed plan to MMS, now the Bureau of Ocean Energy, Management, Regulation and Enforcement (BOEMRE), specifying where and how the well is to be drilled, cased, cemented, and completed
- Serve as general contractor and hire various specialists to work on its lease and perform specific functions in the construction of the well, and direct contractors with respect to their areas of responsibility
- Retain full authority over drilling operations, casing and cementing processes, and temporary abandonment testing and procedures (quality assurance and quality control of well)
- Approve all work to be performed by contractors/subcontractors
- Assist with overall safety on the rig
- Advise and consult with various rig owner personnel on key decisions in heightened-risk situations
- Determine and implement appropriate well-control procedures
- Contain the well and address any pollution from the well

^A BP Exploration & Production Inc., Anadarko Petroleum Corporation, and MOEX Offshore 2007 LLC were the leaseholders in the specified percentages of lease number G32306 for MC252 at the time of the incident.

Examples of Tasks Assigned to Contractors

- Provide rig and rig personnel for drilling operation (Transocean)
- Supervise cement operations, including but not limited to: designing cement program, maintaining equipment for cement jobs, maintaining inventory logs for cementing materials and equipment, and conduct cementing operations (Halliburton)
- Maintain logs of formations drilled during drilling operations (Sperry Sun)
- Monitor and report the presence and quantity of gas in drilling mud (Sperry Sun and Transocean)
- Provide separate measurement equipment for pit volumes, penetration rates, pump pressures, mud flow returns (loss/gain), and sample catching for geological analysis (Sperry Sun)
- Survey the hole and provide information to the operator with respect to the target (Sperry Sun and Schlumberger)
- Recommend mud additives and conduct mud testing (M-I SWACO)
- Calculate mud circulating times and volumes (M-I SWACO)
- Monitor mud properties of the drilling fluid and maintain drilling fluid logs (M-I SWACO)
- Design drilling fluid program and monitor fluid properties (M-I SWACO)
- Execute adjustments to mud properties and monitor mud weight (Transocean and M-I SWACO)

1.2 Companies Involved in Drilling the Macondo Well

The primary companies involved in drilling the Macondo well were:

BP

BP personnel in Houston, Texas, managed the development and operation of the Macondo well, and provided direction and support to their personnel onboard the *Deepwater Horizon*. These onshore personnel consisted of three engineers, an engineer team leader, an operations team leader, and a manager. BP offshore personnel consisted of two well site leaders, a well site trainee, and three subsea personnel. The well site leaders exercised BP's authority on the rig, directed and supervised operations, coordinated the activities of contractors, and reported to BP's shore-based team.

BP's contractors for the Macondo well included:

Transocean

BP contracted Transocean to provide the *Deepwater Horizon* drilling rig and the personnel to operate it. The Transocean team included the drill, marine, and maintenance crews. The senior Transocean personnel involved in day-to-day operations were the offshore installation manager (OIM) and the captain. The OIM was the senior Transocean manager onboard who coordinated rig operations with BP's well site leaders and generally managed the Transocean crew. The captain was responsible for all marine operations and was the ultimate command authority during an emergency and when the rig was underway from one location to another.

The Transocean drill team was led by a senior toolpusher, who supervised two toolpushers responsible for coordinating the round-the-clock drilling operations. The toolpushers supervised the drillers and assistant drillers, who operated the drilling machinery and monitored the rig instruments. At the time of the incident, there were 79 Transocean personnel onboard the *Deepwater Horizon*, including nine who lost their lives.

Halliburton

BP contracted Halliburton to provide specialist cementing services and expertise and to support the BP teams both onshore and on the *Deepwater Horizon*. At the time of the incident, two Halliburton cementing specialists were onboard the *Deepwater Horizon*.

Sperry Sun

BP contracted Sperry Sun to install a sophisticated well monitoring system on the *Deepwater Horizon*. Sperry deployed trained personnel, or mud loggers, to monitor the system, interpret the data it generated, and detect influxes of hydrocarbons, or kicks. At the time of the incident, there were two Sperry Sun mud loggers onboard the *Deepwater Horizon*.

M-I SWACO

BP contracted M-I SWACO to provide specialized drilling mud and mud engineering services on the *Deepwater Horizon*, which included mud material, equipment, and personnel. At the time of the incident, there were five M-I SWACO personnel onboard the *Deepwater Horizon*, including two who lost their lives.

Schlumberger

BP contracted Schlumberger to provide specialized well and cement logging services on the *Deepwater Horizon*, which included equipment and personnel. At the time of the incident, no Schlumberger personnel were onboard the *Deepwater Horizon*.

Weatherford

BP contracted Weatherford to provide casing accessories, including centralizers, the float collar, and the shoe track on the *Deepwater Horizon*. Weatherford also provided specialist personnel to advise BP and the drill crew on the installation and operation of their equipment. At the time of the incident, two Weatherford personnel were onboard the *Deepwater Horizon*.

Tidewater Marine

BP contracted Tidewater Marine to provide the offshore supply vessel the *Damon B. Bankston*. The *Bankston* carried supplies (such as drilling equipment, drilling chemicals, food, fuel oil, and water) to and from the *Deepwater Horizon*. At the time of the incident, the *Bankston* was alongside the *Deepwater Horizon* and provided emergency assistance.

Other personnel onboard the *Deepwater Horizon* included 14 catering staff, two BP executives, and 14 BP subcontractors for a total of 126 personnel onboard.

1.3 *Deepwater Horizon* History of Operations

A fifth-generation, dynamically positioned, semi-submersible mobile offshore drilling unit (MODU), the *Deepwater Horizon* was capable of working in water up to 10,000 ft. deep.^{2, B} This capability put the *Deepwater Horizon* at the forefront of oil and gas exploration, as the oil industry looks to deeper waters for new development. In 2009, the *Deepwater Horizon* crew drilled the deepest oil and gas well in the world, which had a vertical depth of 35,050 ft., or more than six miles.

The *Deepwater Horizon* entered service in April 2001 and went to work for BP in the Gulf of Mexico that September. With the exception of one well drilled for BHP Billiton in 2005, the *Deepwater Horizon* worked exclusively for BP. The *Deepwater Horizon* crew drilled more than 30 wells on the U.S. outer continental shelf (OCS) during the course of the rig's career, in water depths between 2,333 ft. and 9,576 ft., and maintained an excellent performance and safety record.^C In September 2009, BP extended its drilling contract on the *Deepwater Horizon* through September 2013.

1.4 Inspections of the *Deepwater Horizon*

The U.S. Coast Guard (USCG), the MMS, the Marshall Islands (the flag state of the *Deepwater Horizon*) and the American Bureau of Shipping (ABS) regularly inspected and certified the *Deepwater Horizon*.

Coastal State Certification – U.S. Coast Guard (USCG)

From the time of her delivery in 2001, the *Deepwater Horizon* operated in the Gulf of Mexico on the outer continental shelf. The USCG certifies all mobile offshore drilling units that operate within the OCS. On July 27, 2009, the USCG renewed the *Deepwater Horizon* Certificate of Compliance, which was valid through July 27, 2011.³

Coastal State Inspection – Minerals Management Service (MMS)

The MMS conducted regular inspections of the *Deepwater Horizon*. These inspections included reviews of test results for the blowout preventer (BOP), the gas detection system, and drilling areas, such as the drill floor and mud pit room. The MMS inspected the *Deepwater Horizon* three times in 2010. The MMS conducted its last inspection of the *Deepwater Horizon* on April 1, 2010, and the inspectors made no findings that required action by the rig crew.⁴

Flag State Inspection – Marshall Islands (MI)

The Marshall Islands inspects its flagged vessels annually using its own inspectors or those from the ABS. In addition to safety inspections, the Marshall Islands requires that its flagged vessels undergo a variety of statutory surveys.^D

The *Deepwater Horizon* last passed her Marshall Islands flag inspections in December 2009, and the rig was current with all inspection requirements at the time of the incident.⁵

B Dynamic positioning is a computer-controlled system to automatically maintain a vessel's position and heading by using its own propellers and thrusters. Position reference sensors combined with wind sensors, motion sensors, and gyroscopic compasses, provide information to the computer about the vessel's position and the amount and direction of environmental forces affecting its position.

C The *Deepwater Horizon* work on the BP Stones well in 9,576 ft. of water set a record for the deepest water depth well drilled by a semisubmersible rig.

D These statutory surveys include the following: International Oil Pollution Prevention; International Sewage Pollution Prevention; International Air Pollution Prevention; International Maritime Organization MODU Code; International Load Line Convention; Annual Ship Radio Station License; Crane Inspection; International Safety Management Code; and International Ship Security Code.

Class Certification – American Bureau of Shipping (ABS)

A classification society verifies that marine vessels and offshore structures comply with the society rules for design, construction, and periodic surveys. The *Deepwater Horizon* was “classed” by the ABS and inspected in accordance with ABS rules. The ABS Class Certificate was renewed on Oct. 19, 2009, and was valid through Feb. 28, 2011.⁶

1.5 Well Operations – February–April 2010

The *Deepwater Horizon* arrived at Macondo on Jan. 31, 2010.⁷ The crew performed maintenance work on the BOP stack, including function and pressure testing, before lowering it onto the wellhead on Feb. 8, 2010. The crew then performed another successful pressure test of the BOP stack after it was attached to the wellhead.⁸ Drilling operations resumed on Feb. 11, 2010.⁹

BP encountered a number of obstacles while drilling Macondo. Two cement repair operations, or squeezes, were required because of weak formations and possible problems with cement. On several occasions, fluid losses into the formation necessitated the use of lost-circulation material (LCM) to stop the escape of fluids. On March 8, 2010, a 35-barrel (bbl) influx of hydrocarbons, or “kick,” occurred, sticking a section of drill pipe in the well.¹⁰ The drill crew had to plug the affected section of the well with cement and drill a side-track in order to continue. In early April, additional fluid losses to the formation prompted BP engineers to change the total planned depth of the well from 20,200 ft. to 18,360 ft. to maintain the integrity of the well.

After drilling was completed on April 9, 2010, Schlumberger conducted a detailed analysis of the well's geological formations, or well logging, for BP over a period of approximately four-and-a-half days. The logging data from the new depth indicated that the well had reached a sizable reservoir of hydrocarbons. BP began planning for the next phase of the development, in which the *Deepwater Horizon* would run casing and prepare the well for temporary abandonment. On April 16, 2010, BP submitted its proposed temporary abandonment plan to the MMS and received approval the same day.¹¹ Temporary abandonment plans are discussed in further detail in *Chapter 3.2*.

1. Daily Drilling Report, Oct. 6, 2009, TRN-USCG_MMS-00011649.
2. *Deepwater Horizon* Operations Manual, March 2001, TRN-HCEC-00018328.
3. Certificate of Compliance, July 27, 2009–July 27, 2011, TRN-MDL-00272564.
4. Rig Inspection Summary Report, April 1, 2010, TRN-HCEC-00066722.
5. Inspection O.N. 2213, Dec. 17, 2009, TRN-MDL-00268111.
6. ABS Survey Manager, April 26, 2010, TRN-HCJ-00127953.
7. Daily Drilling Report, Jan. 31, 2010, TRN-MDL-00011384.
8. Daily Drilling Report, Feb. 11, 2010, TRN-MDL-00026122.
9. *Ibid.*
10. Daily Drilling Report, March 8, 2010, TRN-MDL-00026179.
11. Application for Permit to Modify, April 16, 2010, BP-HZN-SNR00018177.

2 Incident Chronology and Overview

By April 14, 2010, the exploratory phase of the Macondo well was nearly complete. With respect to well operations, the *Deepwater Horizon* had two tasks remaining: (1) running production casing, and (2) preparing the well for temporary abandonment. The *Deepwater Horizon* was scheduled to depart the well once these tasks were completed. By this time, BP had verified the existence of a hydrocarbon reservoir but did not plan to immediately produce it; a different rig would commence completion operations for the operator at a later date.

BP had cut the total depth of the well short of the original target depth because the margin between pore pressure (the pressure at which hydrocarbons push into the wellbore) and the formation fracture pressure (the pressure required to fracture the rock at a given depth) became increasingly narrow with depth, restricting the window for safe drilling.

This chapter provides a summary chronology of activities on the *Deepwater Horizon* between April 14 and April 20, 2010. It also provides an overview of the design, engineering, logistical, and operational challenges related to Macondo. *The investigation team's detailed incident analysis can be found in Chapter 3.*

2.1 Running Production Casing

In the original plan for the Macondo well, BP specified the use of a long-string casing. After experiencing lost-circulation problems, BP considered using a liner to minimize the downhole pressure exerted during installation and cementing.

On April 14–15, 2010, despite the advantages of running a liner, BP engineers decided to retain the original design of a long-string production casing — a single length of 9-7/8-in. x 7-in. casing extending from the subsea wellhead to 13,237 ft. below the seabed (18,304 ft. total depth).

At 3:30 a.m. on April 18, 2010, the *Deepwater Horizon* drill crew began lowering the long-string production casing into place. Six centralizer subs, or centralizers, had been pre-installed on the lower 7-in. interval of the production casing string.¹ This was significantly fewer than the number of centralizers specified in the Halliburton cementing models to prevent high risk of cement channeling and subsequent gas flow.²

Approximately 35 hours later, on April 19, 2010, the drill crew completed running the production casing.

2.2 Converting the Float Collar

Casing is typically installed with two sets of cementing check valves: the float shoe, located on the very bottom of the casing string; and the float collar, usually installed from two to six casing lengths (joints) above the bottom.^A BP's production casing design for the Macondo well called for only one cementing check device: a double valve, auto-fill float collar.

Lowering the casing string into the well with the float equipment installed pushes drilling fluid ahead of it and can create surge pressures that can fracture the formation, leading to loss of drilling fluids and damage of the hydrocarbon production zones. To reduce surge pressure and protect the formation, BP incorporated a surge reduction system including an auto-fill type of float collar and reamer shoe.^B The float collar used at Macondo contained two flapper check valves that are held open during installation by an auto-fill tube. While open, these valves allow mud to pass through the float collar and up into the casing. Before cementing, the float collar is “converted” or closed. Specifically, the auto-fill tube is forced out of the float collar so that the flapper valves close and prevent mud and cement slurry from flowing back up into the casing.

The float collar is converted by applying pressure to a ball that is preinstalled at the base of the auto-fill tube. Two small ports on the sides of the tube allow circulation of drilling fluid through the tube, creating a differential pressure between the top and bottom of the ball. BP's procedure to convert the float collar called for slowly increasing fluid circulation rates to 5–8 barrels per minute (bpm) and applying 500–700 pounds per square inch (psi) of differential pressure, consistent with manufacturer guidelines.³ However, BP deviated from its planned procedures during the conversion.

A The float shoe and/or float collar are typically referred to as the “float equipment”.

B The surge reduction system also included an Allamon diverter sub and diverter test device.

At 2:18 p.m. on April 19, 2010, the drill crew began efforts to convert the float collar. BP directed the drill crew to use a flowrate of only 1 bpm.⁴ At that flow rate, the drilling fluid did not flow through the float assembly, and pressure began to build, indicating that something was blocking circulation. The BP well site leader and drilling engineer on the rig consulted with BP onshore management and decided to continue increasing pressure.⁵

At 4:18 p.m., drilling fluid started to circulate after nine attempts and ramping pressure up to 3,142 psi, which far exceeded the manufacturer guidelines and BP's own procedures for this operation.⁶ Throughout the pumping of cement and displacement, the minimum flowrate (5 bpm) required to activate the float collar was never attained.⁷ With anomalous conversion pressure (3,142 psi), low flow rates (less than 5 bpm), and low circulating pressure (less than modeled after conversion), no definitive evidence existed that the float valves had converted.

After the break in pressure, BP directed the drill crew to continue circulating mud and to monitor the pressure.⁸ The observed circulating pressure was 137 psi instead of the expected 370 psi at 1 bpm, and 350 psi instead of the expected 570 psi at 4 bpm. This prompted discussions among BP engineers and the Halliburton cementing engineer.⁹ The *Deepwater Horizon* drill crew circulated the well with drilling mud to confirm that the diverter tool (part of the surge reduction system) had closed.¹⁰ The circulation performed never reached the required flowrate of 5–8 bpm. BP onshore management directed the BP well site leader to continue with cementing operations.¹¹

Debris inside the casing or landing string from prior operations can interfere with cementing.^c Thus, before cementing, clean drilling mud is pumped down and through the well to push debris out of the casing to ensure nothing will impede the circulation of cement. Circulating a full “bottoms-up” using the full volume of mud from bottom to surface is considered a best practice prior to cementing. The absolute minimum mud volume is the volume of the drill pipe and casing plus a safety factor. At Macondo, the original BP well plan called for circulation of 1,315 bbl, which was 1.5 times the casing volume.¹² This was later modified on the updated casing program of April 15 to “circulate at least one (1) casing and drill pipe capacity, if hole conditions allow.”

BP performed only a limited circulation of 111 bbl.¹³ The total volume circulated, including circulation after float conversion, was 346 bbl,¹⁴ significantly less than the 1,315 bbl required in the original drilling program and the 2,750 bbl required for a full bottoms-up circulation.¹⁵

2.3 Cementing

Given its knowledge of the narrow window for safe drilling, BP selected a technically complex cement program that minimized the pressure exerted on the formation. Transocean was not involved in the planning or design of the cement program. The key features of the cement program included:

- Using a lower density nitrified slurry cement
- Using a small volume of cement
- Pumping the cement into the well at a low rate

At 7 p.m. on April 19, 2010, BP directed Halliburton to commence cementing operations on the long-string production casing using the nitrified foam cement slurry designed by Halliburton. BP decided to proceed without having final lab results from Halliburton to confirm the stability of the nitrogen foam slurry and the associated crush compressive strengths.¹⁶ The *Deepwater Horizon* drill crew and shore-based personnel were not given information regarding the cement design, lab test results, or potential risks associated with the cement program as planned and designed by BP and Halliburton.

After circulating with mud, the Halliburton cementer pumped 7 bbl of base oil followed by 10 bbl of spacer^d from the cement unit.¹⁷ A BP cementing specialist had directed using base oil, which is less dense than mud, to minimize the risk of formation fracture.¹⁸ At 7:57 p.m. on April 19, 2010, the Halliburton cementer shut down the cement unit pumps and pressure tested the cement lines for five minutes to verify that there were no leaks.¹⁹ After completing a successful pressure test, the Halliburton cementer pumped additional spacer into the well.²⁰

C When utilizing a subsea wellhead system, the casing string is placed inside the wellhead on the sea floor. A landing string is the drill pipe that is utilized to install the casing, casing hanger, and casing hanger seal assembly in the subsea wellhead. Prior to cementing the casing, a sufficient volume of fluid (drilling mud) should be pumped to ensure there is no debris that has inadvertently been dropped inside the casing or landing string that would inhibit the circulation of cement.

D A spacer is a heavy fluid designed to separate seawater from the oil-based drilling mud.

The Halliburton cementer then mixed the base cement slurry and pumped it into the well, followed by nitrogen foam cement slurry and the tail slurry.²¹ Afterward, the Halliburton cementer pumped 21.9 bbl of spacer into the well using the cement unit, followed by 132 bbl of mud for displacement at a rate of 4 bpm.²² This volume was sufficient to launch the top cement wiper plug from the subsea running tool at the wellhead. At this point, mud pump 3 on the rig was utilized to continue the cement displacement.

At 12:36 a.m. on April 20, 2010, mud pump 3 completed the mud displacement (also at 4 bpm).²³ After the cement was in place, the seal assembly was set and tested, and the BP well team and shore based drilling engineer, who was onboard, notified their onshore counterparts that the cement job had gone as planned.²⁴

2.4 Temporary Abandonment Plan

After approving the cement job, BP proceeded with temporary abandonment. Temporary abandonment is the process by which a well is secured so the operator can safely leave the well before returning to begin completion operations.²⁵ This process requires displacing the drilling mud with seawater and sealing the well with a cement plug and/or mechanical plug.

BP engineers generated at least five different temporary abandonment plans for the Macondo well between April 12 and April 20, 2010.²⁶ The procedures varied considerably, calling for different sequences of activity, different depths at which to set the surface cement plug, different displacements, and different negative pressure test procedures. It appears that BP never subjected the procedural changes to a formal risk assessment.

The April 16, 2010, version of the temporary abandonment procedure was submitted to the Minerals Management Service (MMS), now the Bureau of Ocean Energy Management, Regulation and Enforcement (BOEMRE), and approved the same day.²⁷ However, the plan was altered on April 20, 2010, after the shore-based BP well team determined that a negative pressure test on the kill line to the wellhead would not produce enough differential pressure to simulate the seawater displacement to 8,367 ft. (3,300 ft. below the mudline).

At 10:43 a.m. on April 20, 2010, after the temporary abandonment was already underway, BP shore-based engineers sent their final amended temporary abandonment plan to the rig.²⁸ It called for displacement of the weighted drilling fluid with seawater before setting a secondary cement barrier. It also directed the drill crew to displace to 3,300 ft. below the mudline with seawater in order to set the surface cement plug in water. However, the plan still maintained monitoring the negative pressure test on the kill line, as specified in BP's MMS-approved temporary abandonment plan.

Despite the questions that remained regarding the integrity of the production cement and the float collar conversion, there is no indication that a formal risk assessment was performed to evaluate the final temporary abandonment plan.

On April 20, 2010, M-I SWACO developed, and BP approved, a displacement procedure that incorporated an unusually large amount (425 bbl) of 16-pounds-per-gallon (ppg) spacer to complete the displacement.²⁹ Instead of using normal spacer material, BP mixed two viscous lost-circulation materials, or "pills," left over from prior rig operations. Combining these water-based pills into one spacer would mean that they could legally be discharged overboard rather than taken to shore for costly disposal. BP also used an abnormally large volume of the spacer material: 425 barrels, more than double the average volume used in previous displacements.

2.5 Displacement

Upon completion of the cement program, the drill crew set up and ran into the well a 6-5/8-in. x 5-1/2-in. x 3-1/2-in. tapered drill string.³⁰ While at 4,817 ft., with the drill string just above the blowout preventer (BOP) stack, the blind shear ram (BSR) was closed to perform a positive casing test.³¹ The positive casing test confirmed the casing was competent and that the BSR had sealed.

After completing the positive casing test, the drill crew continued to run in the hole with the tapered drill string to 8,367 ft. (3,300 ft. below the mud line).³²

The drill crew began displacement on April 20, 2010, at 3:03 p.m. and completed it at 4:52 p.m.³³ During this time, the *Deepwater Horizon* transferred mud from its pits to the *Damon B. Bankston*, an adjacent supply vessel.³⁴ Mud returning from the riser was captured in the active mud pits of the rig, and as the active pits filled, the crew transferred mud from the active pits into the auxiliary pits and from auxiliary pits to the *Bankston*.³⁵ Transfers to the *Bankston* ended at 5:10 p.m.³⁶

Although the plan was to displace the entire volume of the spacer above the BOP stack, post-incident analysis revealed that the volume of seawater pumped was inadequate to accomplish that, resulting in a portion of the spacer remaining below the BOP stack.³⁷

2.6 Negative Pressure Test

The April 20, 2010, temporary abandonment procedure provided for a negative pressure test after initial displacement was concluded.³⁸ Typically, a negative pressure test is performed before the mud in the wellbore and riser is displaced with seawater.

A negative pressure test confirms the integrity of barriers in the well (such as cement barriers, mechanical barriers, casing, and seal assembly) by simulating the reduction in hydrostatic pressure that occurs when heavy mud is displaced with lighter seawater, and the BOP stack and the riser are removed. The test is critical to determine that the cement will block flow from the reservoir after mud is replaced with seawater. Importantly, it was the only means of testing the float collar valves and downhole cement.

The design and interpretation of a negative pressure test is the responsibility of the operator. The test design may vary from well to well, as there is no established industry standard or MMS procedure for performing a negative pressure test. To conduct the test, pressure inside the well is reduced to fall below the pressure outside the well, and then the well is monitored. This process simulates the well condition at the time of abandonment. The test is deemed successful if there is no indication that hydrocarbons have entered the well, as characterized by no pressure increase if the well is shut in and by no flow if the well is open.

At 4:52 p.m. on April 20, 2010, the drill crew shut down the mud pumps on the rig and closed the lower annular BOP to isolate the riser fluid above the BOP in preparation for the negative pressure test.³⁹ During the negative pressure test, pressure was bled off three separate times in an attempt to reduce the drill pipe pressure to 0 psi so that the well could be monitored.⁴⁰ After each bleed, the pressure returned when the well was shut in.⁴¹

The first attempt to bleed pressure from the drill pipe resulted in a decline from 1,395 psi to 240 psi.⁴² The well was shut in, and the drill pipe pressure increased to 1,250 psi.⁴³ During this bleed, the crew noticed a drop in the riser fluid level, indicating that heavy spacer had moved below the closed annular.⁴⁴ The lower annular closing pressure was increased, the annular sealed successfully, and the drill crew then refilled the riser with drilling mud.⁴⁵

At 5:26 p.m. on April 20, 2010, the drill pipe was bled to 0 psi.⁴⁶ The BP well site leader then instructed the drill crew to open the kill line and conduct the negative pressure test by monitoring for flow via the kill line as specified in the MMS-approved April 16 temporary abandonment plan.⁴⁷

When the kill line was opened, fluid flowed from the drill pipe to the cement unit, and the well was shut in for a second time, which isolated the pressure gauges.⁴⁸ Pressure increased in the well with no corresponding pressure readings on the drill pipe gauges.

At 5:52 p.m., a valve was opened, exposing the drill pipe pressure gauge to the pressure that had built in the well,⁴⁹ and the drill pipe pressure gauge showed an increase.

The crew again bled drill pipe pressure; it declined to nearly 0 psi, and the well was shut in. The drill pipe pressure increased to 1,400 psi. Post-incident analysis shows that the well was likely in communication with the formation.⁵⁰ Both BP well site leaders arrived on the rig floor, and discussions occurred regarding pressure on the drill pipe and the method of conducting the negative pressure test.⁵¹

At 7:15 p.m. on April 20, 2010, the BP well site leader instructed the drill crew to monitor the kill line for flow instead of the drill pipe.⁵² The kill line was connected to the mini trip tank. The mini trip tank was monitored for 30 minutes, and no flow was observed by BP or Transocean.⁵³ BP approved the test. The drill crew then bled pressure from the drill pipe and opened the annular BOP to continue displacement of the riser.⁵⁴

2.7 Sheen Test and Final Displacement

The final displacement procedure called for pumping seawater to displace the remaining 14-ppg drilling mud from the riser into the rig mud pits and the 16-ppg spacer from the riser to the surface, at which time the crew would reset to direct flow and discharge the spacer overboard into the Gulf of Mexico.⁵⁵ Regulations do not permit oil-based materials, such as drilling mud, to be discharged overboard; however, most water-based materials, such as spacer, are permitted to be discharged overboard.

The drill crew resumed final displacement at 8:02 p.m. on April 20, 2010.⁵⁶

As the drilling mud was displaced, the investigation found that the well became underbalanced to one or more of the formations sometime between 8:38 p.m. and 8:52 p.m., but there was no clear indication of an influx at that time.⁵⁷

At 9:09 p.m. on April 20, 2010, when the spacer was expected at the surface, the pumps were shut down for the compliance engineer to conduct a sheen test to verify that the displacement of synthetic oil-based mud was complete and that it was appropriate to discharge the remaining water-based fluids in the riser overboard into the sea. The compliance engineer specialist took a sample of the well fluids exiting the riser.⁵⁸

Between 9:09 p.m. and 9:13 p.m., during the four-minute interval that the sheen test was conducted, drill pipe pressure increased from 1,013 psi to 1,202 psi.⁵⁹ Based on post-incident analysis, this pressure increase was a result of hydrocarbons flowing into the well.⁶⁰ Both the BP well site leader and the Sperry mud logger performed visual flow checks during this period, but no flow was identified.⁶¹ It is possible that the valve configuration had already been moved to direct returned fluids overboard.

Although the compliance engineer concluded the sheen test was successful, analysis indicates that the spacer had not reached the surface at the time the test was conducted.⁶² The BP well site leader approved the sheen test via a phone call and directed the drill crew to continue with the displacement.⁶³

At 9:13 p.m. on April 20, 2010, pumps 3 and 4 were brought online to pump down the drill pipe and complete the displacement, with riser returns being directed overboard.⁶⁴ At 9:17 p.m., when pump 2 was brought online to pump down the kill line and boost the riser, pressure spiked and activated a pressure relief valve.

The drill crew shut down all three pumps immediately to determine which one was affected, and a team was deployed to repair the relief valve on pump 2. Pumps 3 and 4 were brought back online within 20 seconds after relief valve 2 was identified and the pump was isolated. The driller manually increased in the pump speeds over the course of the next 10 minutes to move the spacer out of the well.⁶⁵ Drill pipe pressure increased as the pumps were accelerated.

At approximately 9:30 p.m., the drill crew identified a pressure anomaly and shut down the pumps to investigate.⁶⁶ At 9:31 p.m., the drill pipe pressure fell due to the shutdown of the pumps but did not match the kill line pressure, as it should have. During the discussion of the anomaly, the drill pipe pressure rose between 9:32 p.m. and 9:34 p.m. At 9:36 p.m., the driller directed a floor hand to bleed pressure from the drill pipe until it equalized with the kill line. When the bleed stopped, pressure returned, but to a lower level than previously.

The drill crew changed the flow path to the trip tank to check for flow. By 9:42 p.m., the trip tank filled rapidly, alerting the drill crew to an influx.⁶⁷ The drill crew closed the upper annular BOP element to shut in the well. The actions of the drill crew were consistent with the belief that the well was secure and a plug existed within the lines.

2.8 Activation of the BOP

Upon recognizing an influx,⁶⁸ the drill crew took well-control actions including activating the upper annular BOP, diverting the flow of hydrocarbons from the riser into the mud-gas separator (MGS), and closing both of the variable bore rams (VBRs).

At 9:43 p.m., the drill crew closed the upper annular BOP to shut in the well.⁶⁹ In setting up for the negative pressure test, the driller had positioned the drill pipe tool joint so that only drill pipe was through the ram BOPs. However, the high-volume and high-velocity flow of hydrocarbons up the well forced the drill pipe tool joint upward into the upper annular BOP before it was closed at 9:43 p.m.⁷⁰

During the 26 seconds it took to close, the annular preventer closed partially upon drill pipe and partially upon a tool joint. Hydrocarbons and well debris flowed between the rubber sealing element of the annular preventer and the drill pipe tool joint. The high-velocity flow of material eroded the rubber of the sealing element and the metal of the drill pipe and prevented the annular BOP from sealing. The upper annular BOP, which is designed to close and seal upon multiple diameters of tubular, did not secure the well.⁷¹

Between 9:43 p.m. and 9:45 p.m., post-incident analysis shows that mud overcame the flow-line capacity and overflowed onto the drill floor, indicating that flow into the riser continued either because the upper annular BOP had not sealed the well or gas had entered the riser.⁷²

At approximately 9:45 p.m., the drill crew closed the diverter to direct the flow from the riser to the MGS and advised the bridge team that there was a well-control situation.⁷³ The assistant driller called the senior toolpusher for assistance,⁷⁴ and the toolpusher called the BP well site leader to inform him that there was flow and that the flow was being diverted to the MGS.⁷⁵

It is now known that the MGS was overwhelmed by the flow. Mud and hydrocarbons began to pour out of the MGS vents and other piping, and gas spread rapidly across the aft deck and into the nearby internal spaces, setting off alarms as it spread.⁷⁶

At about 9:47 p.m., the drill crew closed two VBRs and sealed the wellbore.⁷⁷ As the VBRs closed, pressure increased dramatically inside the drill pipe.⁷⁸ Hydrocarbons continued to exhaust onto the rig as gas expanded within the riser to the surface.

About 9:49 p.m., the rig lost main power, followed by two explosions.⁷⁹ Data transmission to shore ended.

Post-incident examination indicates that the eroded drill pipe located in the upper annular BOP burst under the increasing drill pipe pressure, which allowed hydrocarbons to flow through the ruptured drill pipe into the riser. As the rig began to drift away from the wellhead, the drill pipe was stretched between the rig and the BOP stack, where it was being held by the upper annular BOP and VBRs. The rig traveling block fell at approximately 10:20 p.m.; by then the weakened drill pipe had parted under strain in the area of the upper annular BOP, increasing the flow of hydrocarbons through the drill pipe and up the riser.

The loss of the electrical and hydraulic signals from the rig to the BOP stack activated the automatic mode function (AMF).^E The AMF initiated the high-pressure shear circuit to close the blind shear rams (BSRs), which are designed to cut the drill pipe in the BOP stack, seal the well, and close the ST Locks to mechanically hold the BOP rams closed against pressure from the well. The AMF used stored hydraulic pressure from the lower BOP accumulator bottles and did not rely on surface hydraulic or electrical power. When the blind shear rams closed, a portion of the drill pipe became trapped, preventing the rams from completely shearing, closing, and sealing, thereby allowing fluids to continue to flow up the well bore.

^E The BOP has two redundant control systems, called “pods.” One is referred to as the “yellow” pod and the other is called the “blue” pod. The AMF can be activated by either or both.

2.9 Initial Emergency Response, Muster, and Evacuation

At about 9:47 p.m., indicators on the gas detection system alarm panel on the bridge began to activate, first indicating gas in the shale shaker house, quickly followed by indications of gas on the drill floor, then other areas of the *Deepwater Horizon*.^{80, F} The bridge team called the shale shaker house to make a warning, but there was no response.⁸¹ The bridge team then received a call from the engine control room and told the caller that there was a well-control situation.⁸²

The bridge team called the *Bankston* at about 9:48 p.m. and instructed her to move away from the *Deepwater Horizon*.⁸³

At approximately 9:49 p.m., the rig lost main power, immediately followed by two explosions.⁸⁴ The bridge team sounded the general alarm and made a public address (PA) announcement for personnel to muster.⁸⁵

The explosions caused significant damage in the drilling areas and engine rooms and left debris in some sections of the accommodations area, including the internal muster areas. The bridge team made a second PA announcement instructing personnel to muster at the forward lifeboats.⁸⁶

Reacting to the alarms, PA announcements, the loss of power, and the explosions, personnel on the *Deepwater Horizon* made their way to the forward lifeboat station or to the bridge.⁸⁷ Some of the injured required the assistance or support of their co-workers. Two people had to be carried on stretchers to the forward lifeboat stations.⁸⁸

At 9:53 p.m., the bridge team activated the Global Maritime Distress Safety System (GMDSS) and sent the first of several MAYDAY messages using the VHF radio.⁸⁹

At approximately 9:56 p.m., the offshore installation manager (OIM), one of the subsea engineers, and one of the BP well site leaders who were on the bridge attempted to use the BOP control panel to activate the emergency disconnect system (EDS).⁹⁰ The BOP control panel lights were on, indicating that it had power, but post-incident investigation confirmed that the EDS did not activate to separate the rig from the BOP.⁹¹

When the chief engineer reached the bridge, he was advised that the ECR and engine rooms were damaged.⁹² No attempts to restore power were successful.

Personnel conducted search and rescue for others within the accommodation areas,⁹³ but the intense heat of the fires and damage from the explosions prevented search and rescue operations in other areas. Despite these obstacles, 115 of the 126 people onboard the *Deepwater Horizon* were able to make their way, or were assisted, to the forward lifeboat stations.

It was quickly apparent to the bridge team that it was impossible to regain control of the well or to fight the fires. Instructions were given to abandon the rig, and personnel left the bridge to muster at the forward lifeboats.⁹⁴

One hundred people evacuated in the forward lifeboats, including one person on a stretcher in lifeboat No. 1.⁹⁵ The lifeboats were successfully launched within a few minutes of each other — lifeboat No. 2 launched at approximately 10:19 p.m.,⁹⁶ and lifeboat No. 1 at about 10:25 p.m.⁹⁷ The lifeboats proceeded to the nearby *Bankston* under their own power.

Seven people evacuated on one of the three forward, davit-launched life rafts on the rig. Once the life raft had been made ready for launching, one person entered the raft and assisted with loading an injured person on a stretcher onto the raft.⁹⁸ With the stretcher loaded, five other people boarded the raft. It was lowered to the sea at about 10:35 p.m. and then towed by the *Bankston* fast rescue craft (FRC) to the *Bankston*.⁹⁹ Eight people jumped from the forward end of the rig into the sea, four of whom jumped between about 9:59 p.m. and 10:09 p.m., prior to the lifeboats and life raft being launched.¹⁰⁰ The remaining four people jumped after the lifeboat and life raft had been launched at about 10:37 p.m.¹⁰¹ They were all transported to the *Bankston* by the *Bankston* FRC or clung to the life raft and were taken to the *Bankston*.¹⁰²

F There also were gas detection system alarm panels at other locations on the rig, and these would also have lit up but were not being actively monitored. The alarm panel on the bridge is monitored constantly.

The *Bankston* crew first noticed that something was wrong when mud began to “rain” down onto its vessel from the *Deepwater Horizon* at about 9:44 p.m.¹⁰³ Through monitoring radio communications and watching the rig, the captain of the *Bankston* became aware that lifeboats were being prepared for launch and people were jumping into the water. In response, at about 10:12 p.m., he instructed his engineer to launch the *Bankston* FRC to assist the evacuation process.¹⁰⁴

Once all the survivors were onboard the *Bankston*, a muster was organized. At about 11:30 p.m., it was established that there were 115 survivors from the *Deepwater Horizon* onboard the *Bankston*, and 11 people were missing.¹⁰⁵ The 17 most seriously injured survivors were airlifted from the *Bankston* by U.S. Coast Guard helicopters to shore-based hospitals for treatment.¹⁰⁶ Air and sea searches for the missing continued until approximately 7 p.m. on April 23, 2010.

1. Brian Morel e-mail message to Jesse Gagliano, et. al., April 15, 2010, HAL_0010648.
2. 9 7/8" x 7" Production Casing Design Report, April 18, 2010, HAL_0010988.
3. 7" Float Collar Mid Bore, WiperLok Drawing, Jan. 16, 2010, D000401284.
4. Daily Drilling Report, April 19, 2010, TRN-MDL-00011512; Morning Report, April 19, 2010, TRN-MDL-00287353; Data logs (drilling parameters), April 5-20, 2010; Data logs (drilling parameters with cement unit data), April 15-20, 2010.
5. BP Investigation Team Interview of Robert Kaluza, April 28, 2010, BP-HZN-MBI00021237, 44, 54.
6. Data logs (drilling parameters with cement unit data), April 15-20, 2010; Data logs (drilling parameters), April 5-20, 2010; Daily Drilling Report, April 19, 2010, TRN-MDL-00011512; Morning Report, April 19, 2010, TRN-MDL-00287353.
7. Data logs (cement unit data), April 18-20, 2010; Data logs (drilling parameters with cement unit data), April 15-20, 2010; Data logs (drilling parameters), April 5-20, 2010.
8. BP Investigation Team Interview of Robert Kaluza, April 28, 2010, BP-HZN-MBI00021237, 71; Data logs (drilling parameters), April 5-20, 2010; Data logs (drilling parameters with cement unit data), April 15-20, 2010. Note: Robert Kaluza states pump 3 was used before switching to pump 4, but the data shows that pump 4 was used first before switching over to pump 3.
9. BP Investigation Team Interview of Robert Kaluza, April 28, 2010, BP-HZN-MBI00021237, 71; Data logs (drilling parameters), April 5-20, 2010; Data logs (drilling parameters with cement unit data), April 15-20, 2010.
10. Daily Drilling Report, April 19, 2010, TRN-MDL-00011512.
11. BP Investigation Team Interview of Robert Kaluza, BP-HZN-MBI00139512, 14.
12. GoM Exploration Wells 7" x 9-7/8" Interval, April 15, 2010, BP-HZN-CEC021281.
13. Data logs (drilling parameters with cement unit data), April 15-20, 2010; Data logs (drilling parameters), April 5-20, 2010.
14. Data logs (drilling parameters with cement unit data), April 15-20, 2010; Data logs (drilling parameters), April 5-20, 2010.
15. GoM Exploration Wells 7" x 9-7/8" Interval, April 15, 2010, BP-HZN-CEC021281.
16. BP, Deepwater Horizon Accident Investigation Report, Appendix J: Halliburton Lab Results- # 73909/2.
17. Data logs (drilling parameters with cement unit data), April 15-20, 2010; Data logs (cement unit data), April 18-20, 2010; Halliburton 9.875" x 7" Foamed Production Casing Post Job Report, April 20, 2010, BP-HZN-MBI 00170986; Halliburton Cement Tally Book Notes, HAL-0000515.
18. Testimony of Greg Walz, Hearing before the *Deepwater Horizon* Joint Investigation Team, Oct. 7, 2010, 91-5-11.
19. Data logs (cement unit data), April 18-20, 2010; Halliburton 9.875" x 7" Foamed Production Casing Post Job Report, April 20, 2010, BP-HZN-MBI-00170986; Halliburton Cement Tally Book Notes, HAL-0000515.
20. *Ibid.*
21. 9.875" x 7" in Casing Job Procedure, HAL_0010952, 53; Halliburton 9.875" x 7" Foamed Production Casing Post Job Report, April 20, 2010, BP-HZN-MBI-00170986; Halliburton Cement Tally Book Notes, HAL-0000515.
22. Data logs (cement unit data), April 18-20, 2010; Halliburton 9.875" x 7" Foamed Production Casing Post Job Report, April 20, 2010, BP-HZN-MBI-00170986; Halliburton Cement Tally Book Notes, HAL-0000515.
23. Data logs (drilling parameters with cement unit data), April 15-20, 2010, Data logs (drilling parameters), April 5-20, 2010; Halliburton 9.875" x 7" Foamed Production Casing Post Job Report, April 20, 2010, BP-HZN-MBI-00170986; Halliburton Cement Tally Book Notes, HAL-0000515.

24. Daily Drilling Report, April 20, 2010, TRN-MDL-00011518; Brian Morel e-mail message to John Guide, et. al., April 20, 2010, BP-HZN-MBI-00129057.
25. Application for Permit to Modify, April 16, 2010, BP-HZN-MBI00023711, 13; Daily Drilling Report, April 20, 2010, TRN-MDL-00011518.
26. GoM Exploration Wells 7" x 9 7/8" Interval, April 12, 2010, BP-HZN-CEC021260; Brian Morel e-mail message to James Wilson and Ronald Sepulvado, April 14, 2010, BP-HZN-MBI00126982; GoM Exploration Well Surface and Cement Plug, April 15, 2010, BP-HZN-CEC017621, 28; Application for Permit to Modify, April 16, 2010, BP-HZN-SNR00018177; Brian Morel e-mail message to Don Vidrine, et. al., April 20, 2010, BP-HZN-CEC020165.
27. Application for Permit to Modify, April 16, 2010, BP-HZN-SNR00018177.
28. BP Investigation Team Interview of Robert Kaluza, April 28, 2010, BP-HZN-CEC-020165; Daily Drilling Report, April 20, 2010, TRN-MDL-00011518.
29. Testimony of Leo Lindner, Hearing before the *Deepwater Horizon* Joint Investigation Team, July 19, 2010, 271:25, 272:13; Rheliant Displacement Procedure, BP-HZN-MBI00170827.
30. Engineer's Handwritten Tally Book, BP-HZN-MBI00139592; Testimony of Micah Burgess, USCG/BOEM Marine Board of Investigation, May 29, 2010, 111:7–15; Transocean Investigation Team Interview of Brandon Burgess, June 29, 2010; Transocean, Daily Drilling Report, April 20, 2010, TRN-MDL-00011518.
31. Daily Drilling Report, April 20, 2010, TRN-MDL-00011518.
32. Daily Drilling Report, April 20, 2010, TRN-MDL-00011518.
33. Data logs (drilling parameters with cement unit data), April 15–20, 2010.
34. Testimony of Leo Lindner, Hearing before the *Deepwater Horizon* Joint Investigation Team, July 19, 2010, 270:16-21.
35. Rheliant Displacement Procedure, BP-HZN-MBI00170827; Data logs (mud pit data), April 19–20, 2010, BP-TO11000827.
36. Data logs (mud pit data), April 19–20, 2010, BP-TO11000827; *Damon Bankston* Log, April 20, 2010, TDW0020, 1.
37. Stress Engineering Services Inc., Hydraulic Analysis of Macondo #252 Well Prior to Incident of April 20, 2010, April 27, 2011.
38. Brian Morel e-mail to Don Vidrine, et al., April 20, 2010, BP-HZN-MBI000129113.
39. Data logs (drilling parameters with cement unit data), April 15-20, 2010.
40. Stress Engineering Services Inc., Hydraulic Analysis of Macondo #252 Well Prior to Incident of April 20, 2010, April 27, 2011.
41. *Ibid.*
42. Data logs (cement unit data), April 18–20, 2010.
43. *Ibid.*
44. BP Investigation Team Interview of Robert Kaluza, April 28, 2010, BP-HZN-MBI00139512, 18; Data logs (mud pit data), April 19–20, 2010, BP-TO11000827.
45. Data logs (mud pit data), April 19–20, 2010, BP-TO11000827; Testimony of Jimmy Harrell, Hearing before the *Deepwater Horizon* Joint Investigation Team, May 27, 2010, 25:20-24; Transocean Investigation Team Interview of Mark Hay, May 18, 2010.
46. BP Investigation Team Interview of Robert Kaluza, April 28, 2010, BP-HZN-MBI00139499,504; Data logs (cement unit data), April 18–20, 2010.
47. BP Investigation Team Interview of Robert Kaluza, April 28, 2010, BP-HZN- MBI00139499,504.
48. BP Investigation Team Interview of Robert Kaluza, April 28, 2010, BP-HZN- MBI00139499,504; Data logs (drilling parameters with cement unit data), April 15–20, 2010.
49. Data logs (drilling parameters with cement unit data), April 15–20, 2010.

50. Data logs (drilling parameters with cement unit data), April 15–20, 2010; Stress Engineering Services Inc., Hydraulic Analysis of Macondo #252 Well Prior to Incident of April 20, 2010, April 27, 2011.
51. BP Investigation Team Interview of Don Vidrine, April 27, 2010, BP-HZN-MBI00021406, 18.
52. BP Investigation Team Interview of Don Vidrine, April 27, 2010, BP-HZN-MBI00021406, 7.
53. *Ibid.*
54. Data logs (drilling parameters with cement unit data), April 15–20, 2010; BP Investigation Team Interview of Don Vidrine, April 27, 2010, BP-HZN-MBI00021406, 19.
55. M-I SWACO, Rheliant Displacement Procedure, BP-HZN-MBI00170827;
56. Data logs (cement unit data), April 18–20, 2010; Data logs (drilling parameters with cement unit data), April 15–20, 2010.
57. Stress Engineering Services Inc., Hydraulic Analysis of Macondo #252 Well Prior to Incident of April 20, 2010, April 27, 2011.
58. Testimony of Gregory Meche, Hearing before the Deepwater Horizon Joint Investigation Team, May 28, 2010, 175:11 - 176:5.
59. *Ibid.*
60. Stress Engineering Services Inc., Hydraulic Analysis of Macondo #252 Well Prior to Incident of April 20, 2010, April 27, 2011.
61. BP Investigation Team Interview of Don Vidrine, April 27, 2010, BP-HZN-MBI00021406, 7, 24; Testimony of Joseph Keith, Hearing before the *Deepwater Horizon* Joint Investigation Team, Dec. 7, 2010, 118–120.
62. Stress Engineering Services, Inc., Hydraulic Analysis of Macondo #252 Well Prior to Incident of April 20, 2010, April 27, 2010.
63. BP Investigation Team Interview of Don Vidrine, April 27, 2010, BP-HZN-MBI00021406, 24.
64. Data logs (drilling parameters with cement unit data), April 15–20, 2010.
65. Data logs (drilling parameters with cement unit data), April 15–20, 2010.
66. Transocean Investigation Team Interview of David Young, June 1, 2010; Sperry Drilling Services data logs (drilling parameters with cement unit data), April 15–20, 2010; Sperry Drilling Services data logs (cement unit data), April 18–20, 2010; Sperry Drilling Services data logs (drilling parameters), April 5–20, 2010.
67. Data logs (mud pit data), April 19–20, 2010, BP-TO11000827.
68. *Ibid.*
69. Stress Engineering Services Inc., Hydraulic Analysis of Macondo #252 Well Prior to Incident of April 20, 2010, April 27, 2011.
70. Stress Engineering Services Inc., Hydraulic Analysis of Macondo #252 Well Prior to Incident of April 20, 2010, April 27, 2011.
71. *Ibid.*
72. See Appendix G, 134–136; Testimony of Micah Sandell, Hearing before the *Deepwater Horizon* Joint Investigation Team, May 29, 2010, 9-11; Stress Engineering Services Inc., Hydraulic Analysis of Macondo #252 Well Prior to Incident of April 20, 2010, April 27, 2011.
73. Testimony of Micah Sandell, Hearing before the *Deepwater Horizon* Joint Investigation Team, May 29, 2010, 9–11.
74. Testimony of Randy Ezell, Hearing before the *Deepwater Horizon* Joint Investigation Team, May 28, 2010, 41:15–25.
75. BP Investigation Team Interview of Don Vidrine, April 27, 2010, BP-HZN-MBI00021406, 21.
76. Testimony of Micah Sandell, Hearing before the *Deepwater Horizon* Joint Investigation Team, May 29, 2010, 9-11.
77. Data logs (drilling parameters with cement unit data), April 15–20, 2010; Data logs (cement unit data), April 18–20, 2010.
78. *Ibid.*
79. *Ibid.*
80. Testimony of Andrea Fleytas, Hearing before the *Deepwater Horizon* Joint Investigation Team, Oct. 5, 2010, 13:11-13; Transocean Investigation Team Interview of, Andrea Fleytas, June 24, 2010; Testimony of Yancy Keplinger, Hearing before the *Deepwater*

- Horizon* Joint Investigation Team, Oct. 5, 2010, 149:25-150:6; Testimony of Paul Meinhart, Hearing before the *Deepwater Horizon* Joint Investigation Team, May 11, 2010, 28:20-21.
81. Testimony of Yancy Keplinger, Hearing before the *Deepwater Horizon* Joint Investigation Team, Oct. 5, 2010, 150:6–12; Testimony of Andrea Fleytas, Hearing before the *Deepwater Horizon* Joint Investigation Team, Oct. 5, 2010, 39:6–21.
 82. Testimony of Andrea Fleytas, Hearing before the *Deepwater Horizon* Joint Investigation Team, Oct. 5, 2010, 13:19-23.
 83. Testimony of Paul Meinhart, Hearing before the *Deepwater Horizon* Joint Investigation Team, May 29, 2010, 29:5–12; Weekly Leader Episode 68 (Podcast) of Captain Alwin Landry, (broadcasted on Oct. 14, 2010, interviewed Oct. 5, 2010).
 84. The United States Coast Guard, Paul Meinhart Witness Statement, April 21, 2010; The United States Coast Guard, Douglas Brown Witness Statement, April 21, 2010.
 85. Testimony of Yancy Keplinger, Hearing before the *Deepwater Horizon* Joint Investigation Team, Oct. 5, 2010, 152:7–10; Transocean Investigation Team Interview of Mike Mayfield, June 3, 2010; Testimony of Greg Meche, Hearing before the *Deepwater Horizon* Joint Investigation Team, May 28, 2010, 194:10–20.
 86. Testimony of Andrea Fleytas, Hearing before the *Deepwater Horizon* Joint Investigation Team, Oct. 5, 2010, 14:8–10; Testimony of Micah Burgess, Hearing before the *Deepwater Horizon* Joint Investigation Team, May 29, 2010, 84:2-8.
 87. Testimony of Stephen Bertone, Hearing before the *Deepwater Horizon* Joint Investigation Team, July 19, 2010, 35:3–36:3; The United States Coast Guard, John Quebodeaux Witness Statement, April 21, 2010.
 88. Statement of Buddy Trahan, TRN-MDL-00120230; Testimony of David Young, Hearing before the *Deepwater Horizon* Joint Investigation Team, May 27, 2010, 268:16–23.
 89. Testimony of Andrea Fleytas, Hearing before the *Deepwater Horizon* Joint Investigation Team, Oct. 5, 2010, 14:17-19; The United States Coast Guard, Yancy Keplinger Witness Statement, undated, TRN-HCJ-00121037.
 90. Testimony of Curt Kuchta, Hearing before the *Deepwater Horizon* Joint Investigation Team, May 27, 2010, 189:25–190:8; Testimony of Chris Pleasant, Hearing before the *Deepwater Horizon* Joint Investigation Team, May 28, 2010, 105:23, 106:7; Testimony of Jimmy Harrell, Hearing before the *Deepwater Horizon* Joint Investigation Team, May 27, 2010, 10:17, 11:13.
 91. Testimony of Chris Pleasant, Hearing before the *Deepwater Horizon* Joint Investigation Team, May 28, 2010, 132:9–25; Testimony of Jimmy Harrell, Hearing before the *Deepwater Horizon* Joint Investigation Team, May 27, 2010, 12:7–9, 21:12–22.
 92. Testimony of Stephen Bertone, Hearing before the *Deepwater Horizon* Joint Investigation Team, July 19, 2010, 36:4–37:17.
 93. The United States Coast Guard, Stan Carden Witness Statement, April 21, 2010, TRN-HCJ-00121053; The United States Coast Guard, Chad Murray Witness Statement, April 21, 2010.
 94. Testimony of Andrea Fleytas, Hearing before the *Deepwater Horizon* Joint Investigation Team, Oct. 5, 2010, 68:18–24; Testimony of Yancy Keplinger, Hearing before the *Deepwater Horizon* Joint Investigation Team, Oct. 5, 2010, 152:17–23.
 95. Statement of Buddy Trahan, TRN-MDL-00120230; Transocean Investigation Team Interview of Thomas Cole, June 2, 2010.
 96. The United States Coast Guard, Mike Mayfield Witness Statement, April 21, 2010.
 97. Testimony of Daun Winslow, Hearing before the *Deepwater Horizon* Joint Investigation Team, Aug. 24, 2010, 13:17–25.
 98. Testimony of David Young, Hearing before the *Deepwater Horizon* Joint Investigation Team, May 27, 2010, 268:16–23; Testimony of Steve Bertone, Hearing before the *Deepwater Horizon* Joint Investigation Team, July 19, 2010, 45:6–12.
 99. Testimony of Chad Murray, Hearing before the *Deepwater Horizon* Joint Investigation Team, May 27, 2010, 333:2–4; Testimony of David Young, Hearing before the *Deepwater Horizon* Joint Investigation Team, May 27, 2010, 270:24–271:6.
 100. The United States Coast Guard, Brandon Boullion Witness Statement, April 21, 2010; The United States Coast Guard, Gregory Meche Witness Statement, April 21, 2010; The United States Coast Guard, Shane Faulk Witness Statement, April 21, 2010; Transocean Investigation Team Interview of Matthew Hughes, June 29, 2010.
 101. The United States Coast Guard, Curt Kuchta Witness Statement, April 21, 2010; The United States Coast Guard, Michael Williams Witness Statement, April 21, 2010, TRN-HCJ-00121001; The United States Coast Guard, Yancy Keplinger Witness Statement, April 21, 2010, TRN-HCJ-00121037; The United States Coast Guard, Paul Meinhart Witness Statement, April 21, 2010.
 102. Transocean Investigation Team Interview of Matthew Hughes, June 29, 2010.

103. Testimony of Captain Alwin Landry, Hearing before the *Deepwater Horizon* Joint Investigation Team, May 11, 2010, 99:1–17; Testimony of Paul Erickson, Hearing before the *Deepwater Horizon* Joint Investigation Team, May 11, 2010, 99:1–17.
104. *Damon Bankston* Log, April 20, 2010, TDW-0020.
105. Transocean Investigation Team Interview of Jason Cooley, June 24, 2010; Transocean Investigation Team Interview of Troy Hadaway, May 21, 2010; Transocean Investigation Team Interview of Andrea Fleytas, June 24, 2010.
106. Transocean Park Ten Emergency Response Center Log.

3.1 Well Design and Production Casing Cement

3.1 Well Design and Production Casing Cement

The design of an offshore oil and gas well is exclusively the responsibility of the operator. An operator's geologists and engineers, or their contractors, analyze all available data, including proprietary seismic data, to determine the proper type and strength of the casing, cement, centralizers, reamers, shock absorbers, wellhead, and other equipment and materials that will be used to maintain well integrity and prevent failure throughout the construction and production lifespan of the well. Using this and other information, the operator must develop and submit to the Bureau of Ocean Energy Management, Regulation and Enforcement (BOEMRE), formerly the Minerals Management Service (MMS), a detailed well plan that defines where and how a well is to be drilled, cased, cemented, and completed. Once approved by the agency, the operator's well plan serves as the basis for all decisions that the operator will make during the construction of the well. Drilling and other contractors are hired by the operator to help execute the operator's approved well plan.

This section describes relevant aspects of the design and construction of the Macondo well and explores the extent to which they contributed to the incident.

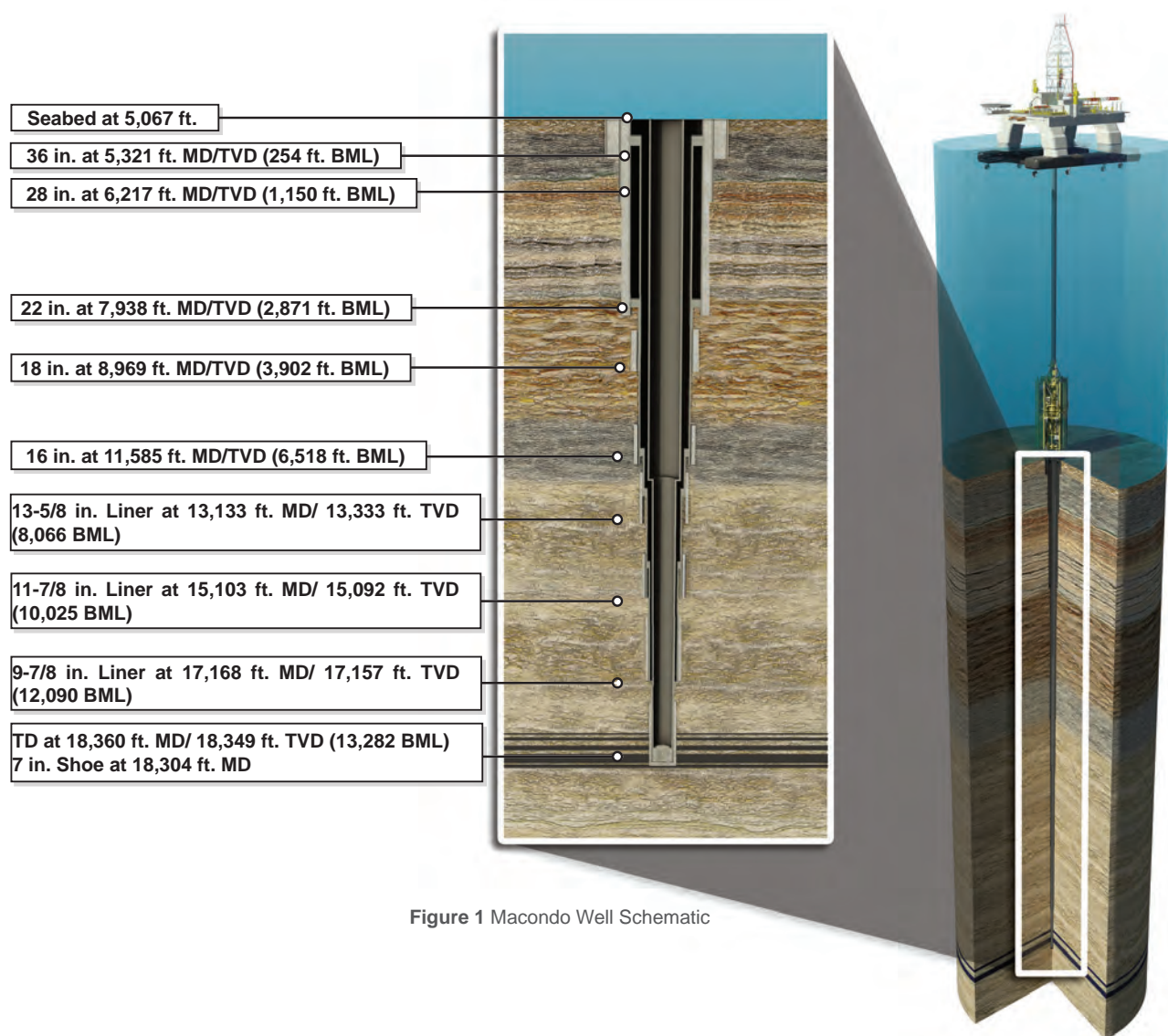

Figure 1 Macondo Well Schematic

3.1.1 The Subsea Wellhead System

A subsea wellhead provides the interface between and support for the casing strings, the blowout preventer (BOP) equipment, and, at a later stage, the completion equipment for a drilled well.

BP selected a Dril-Quip SS-15 Big Bore II subsea wellhead system — a common, high-pressure subsea wellhead utilized for deepwater drilling operations — for the Macondo well.^A The subsea wellhead was installed in two basic steps by the Transocean *Marianas* in October 2009. First, the low-pressure wellhead housing was installed with the structural 36-in. casing, which provided support for shallow conductor casing strings.^{1, B} Then the high-pressure wellhead housing was installed with the 22-in. conductor/surface casing, providing pressure containment and support for subsequent casing strings that would be run.

The remaining wellhead components, the 16-in. casing hanger and seal assembly, and the casing hanger and seal assembly for the 9-7/8-in. x 7-in. production casing, were subsequently installed by the *Deepwater Horizon* crew in early 2010.^{2, C}

Figure 2 depicts the subsea wellhead system installed on the Macondo well.

The installation of the wellhead housing, casing hangers, and seal assemblies occurred without incident.³ On April 20, 2010, at 1:17 a.m., after cementing operations were complete, the last seal assembly installed for the 9-7/8-in. x 7-in. production casing was tested. The seal was tested to 10,000 pounds per square inch (psi) for 30 seconds and then to 6,800 psi for 40 minutes.⁴ After the running assembly was fully released from the casing hanger, a second test was conducted to 10,100 psi for 30 seconds and then to 7,000 psi for 7 minutes to ensure the seals were still effective.⁵ Figure 3 shows the tests conducted on the seal assembly.⁶

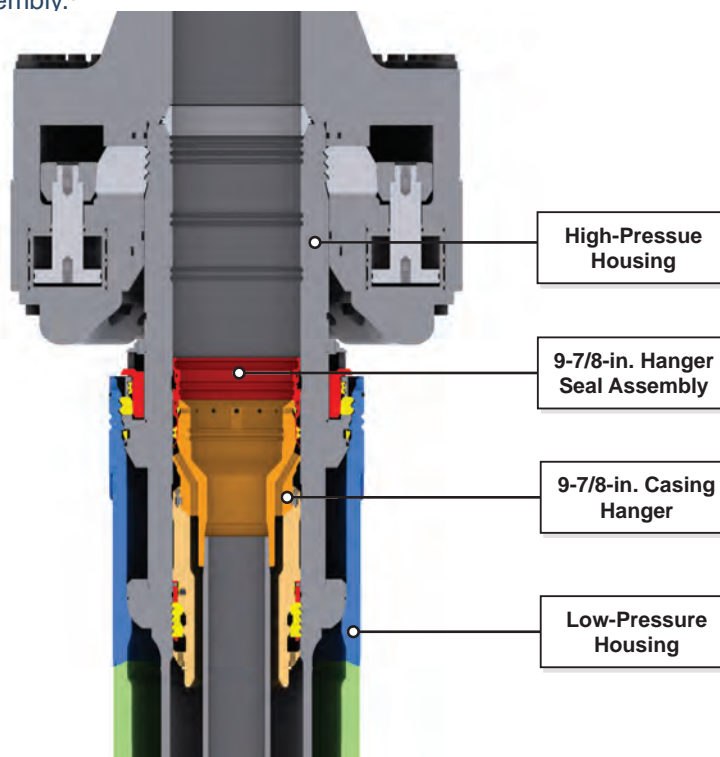

Figure 2 Subsea Wellhead System

- A The SS-15 Big Bore II is a four-hanger wellhead housing system (three casing hangers and one tubing hanger) with the capacity for two additional supplemental casing hangers for 18-in. and 16-in. casing in the 22-in. conductor casing below the wellhead. Its working pressure rating is 15,000 psi.
- B A 28-in. conductor casing was installed via a supplemental casing hanger below the low-pressure housing. An 18-in. liner was installed after the 22-in. conductor casing during the operation with the *Marianas*.
- C Between the 16-in. casing installation and 9-7/8-in. x 7-in. production casing installation, three drilling liners (13-5/8 in., 11-3/4 in., and 9-7/8 in.) were installed.
- D According to the IADC report, both tests were 30 seconds to 10,000 psi and 5 minutes to 6,500 psi.

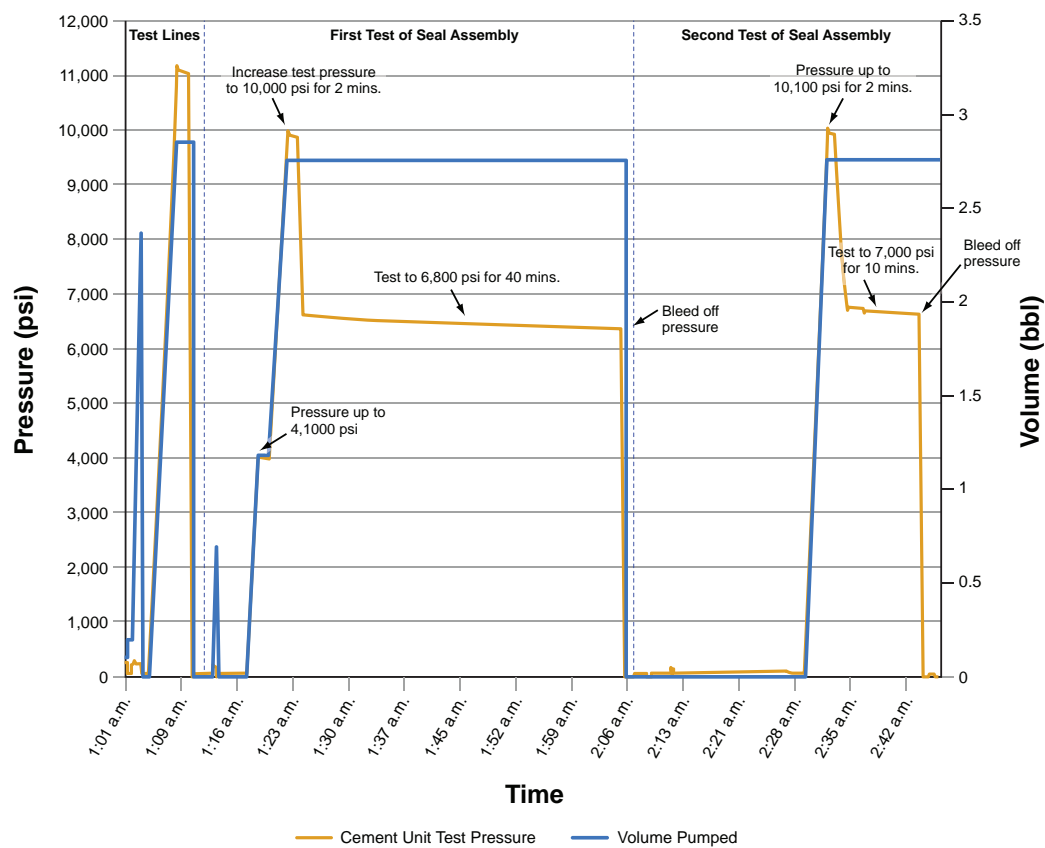

Figure 3 9-7/8-in. Casing Hanger Seal Assembly Tests (1:01–2:47 a.m.)

WHAT IS PRODUCTION CASING?

Casing is a tubular steel material run in different sections of a well. Once cemented in place, it isolates the wellbore from the previously penetrated formations (and their pore pressures) and serves as a conduit from the wellhead to the bottom of the well for drilling and any subsequent production activity. The end section of the casing is known as the shoe track. The shoe track also contains cement that, together with cement in the annulus, serves as the primary barrier preventing the hydrocarbons in the reservoir from flowing up the well. In this way, the shoe track acts as a plug between the inside of the casing and the formation.

Production Casing Hanger and Seal Assembly Condition

The casing hanger and seal assembly for the production casing string were retrieved from the Macondo well under government supervision during post-incident permanent abandonment operations on Oct. 13, 2010.^{7, E}

At the time this report was completed, the official Dril-Quip analysis of the wellhead, casing hanger, and seal assembly condition was still underway. However, the photographic evidence available to the investigation team does not appear to show flow around the outside of the production casing, hanger, and seal assembly; evidence of flow related to the blowout appears from the interior of the casing. *Figures 4 and 5* are photographs obtained after retrieval of the hanger assembly, showing the condition of the production casing hanger after it was retrieved from the well.⁸

Subsea Wellhead Conclusions

Based on available information, the investigation team concluded that there were no failure points associated with the subsea wellhead system or its components, including the low- and high-pressure wellhead housings, the casing hanger, or the seal assembly that contributed to the Macondo incident.

E Previously, a lead impression block was run on Sept. 9, 2010. The result of this operation confirmed the 9-7/8-in. casing hanger was properly seated.

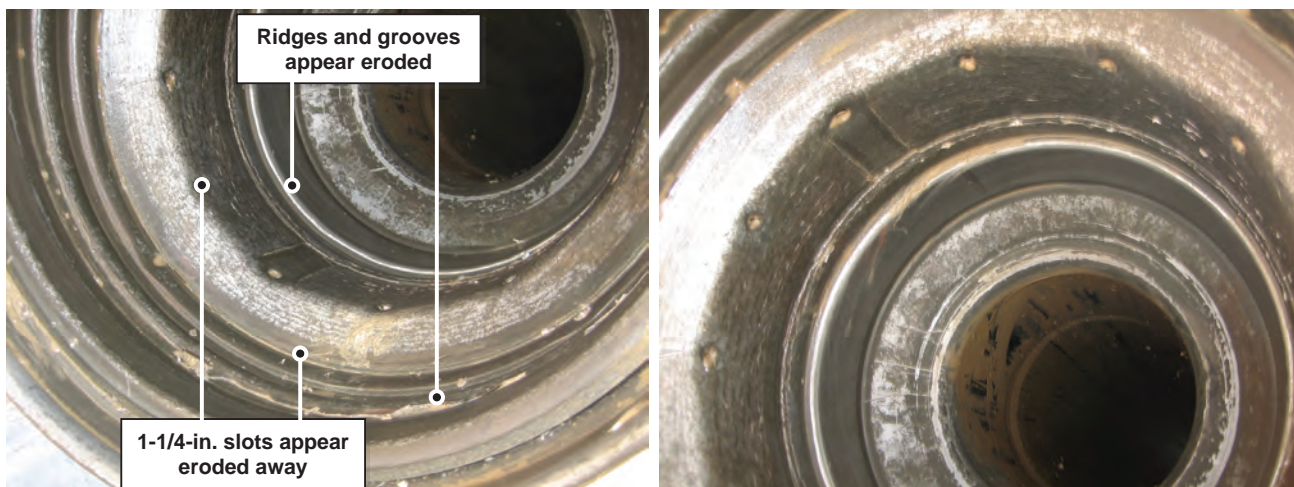

Figure 4 Macondo 9-7/8-in. Casing Hanger (Interior)



Figure 5 Macondo 9-7/8-in. Casing Hanger (Exterior)

3.1.2 Long-String Casing versus Production Liner

There are two types of casing assemblies commonly used: long strings and liners. A conventional long-string casing extends back to and hangs from inside the wellhead. In contrast, a liner is a string of casing that is hung from inside the previous casing shoe and can be “tied back” to the wellhead. A liner may be tied back to the surface (mud line) soon after it has been run, or at a later date prior to commencing production, to provide a continuous casing to the wellhead.

In its original plan for the Macondo well, BP specified the use of a long-string casing.^F After experiencing lost-circulation problems, BP considered using a liner to minimize the downhole pressure exerted during installation and cementing.

^F The 9-7/8-in. long-string production casing design was BP’s primary option as far back as May 2009.

The advantages of running a liner over a conventional long-string casing would have included:^G

- A liner with a tie-back provides two barriers internally and more than two barriers in the annulus. A long string contains just one internal barrier and two annulus barriers.
- A liner can be installed relatively quickly after drilling of the section is complete to reduce problems with wellbore wall stability.
- A liner is less likely to damage the formation: The forces acting on the formation during mud circulation tend to be reduced due to lower flow velocities around the drill pipe and are further reduced by the shorter casing length of a liner, which reduces annulus friction pressure.
- Use of a liner is less likely to cause cement contamination: The internal capacity of the liner and running string is less than that of the long-string casing and drill pipe landing string.
- If a liner becomes stuck prior to reaching bottom, it can be cemented in place and remedial actions can be taken. Long strings require the casing to reach full depth in order to properly land the casing hanger in the subsea wellhead.^H
- Liners provide for better options for cement repairs, if needed.

WHAT IS ECD?

The equivalent circulating density (ECD) is an effect that occurs when pumps are turned on. This critical well monitoring measurement is derived from a formula according to a series of variables, including mud weight, rheological properties of fluids or cement pumped down the well, and the frictional pressure drop in the annulus, among other factors.

Properly managing ECD is a critical challenge in the case of wells with a narrow window between the fracture gradient and the pore-pressure gradient. Fracture gradient refers to the pressure required to fracture rock at a given depth, which could cause fluid losses to the formation. Pore-pressure gradient refers to the hydrostatic pressure required to maintain primary well control and prevent influxes from the formation. When encountering a narrowing window between these two gradients, diligent management of the ECD is required to prevent both fluid loss into the formation (which could lead to fracturing) and an influx of hydrocarbons from the formation into the wellbore.

The long-string casing design used by BP at Macondo imposed stringent limits on allowable ECD. This narrow window drove the design of a cement program that was overly complex and that ultimately failed. The program called for pumping a minimal volume of cement that left room for normal field margin for error; it required exact calculation of annular volume and precise execution in order to produce an effective barrier to the reservoir.

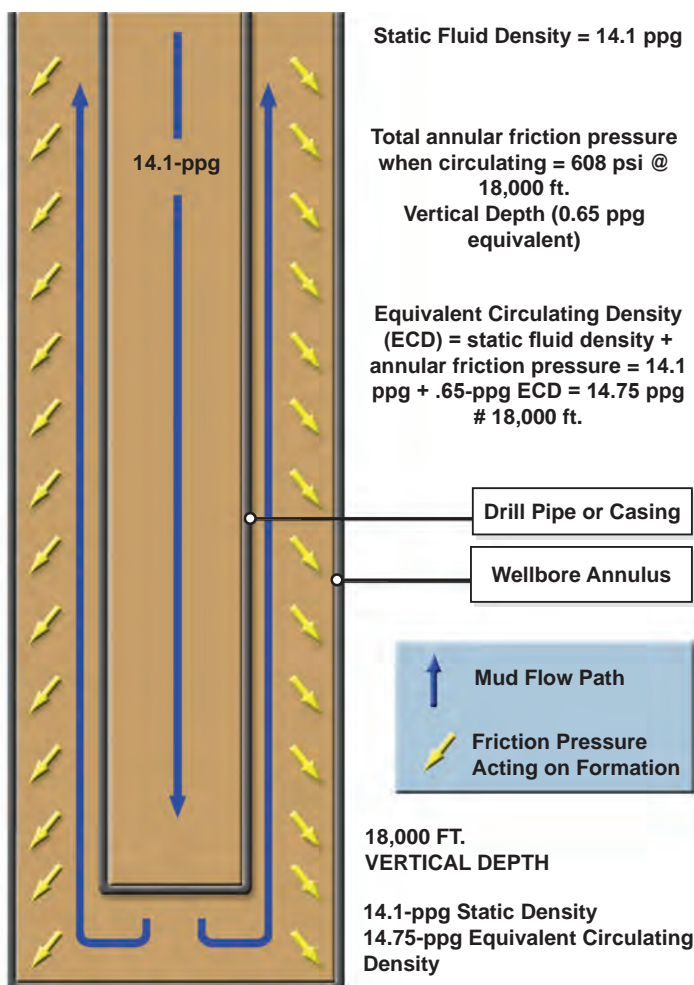

Figure 6 Equivalent Circulating Density

^G Typically, liners reduce the pressure on the formation, as the cement column usually is shorter on a liner than a long string. However, in the case of the Macondo well, BP chose to leave the previous casing shoe exposed, meaning the length of cement would be identical with either the long string or the liner.

^H It is critical to land the casing hanger in the subsea wellhead. If the casing becomes stuck with the hanger in the BOP stack, it could impact the ability to properly function the various blowout preventers. This would require a critical casing cutting and patching operation that would negatively impact the integrity of the casing string.

However, in assessing casing options, BP identified disadvantages of running a liner, specifically, an increased cost of \$7 million–\$10 million and the potential for pressure buildup in the annulus.⁹ Ultimately, despite the advantages of using a liner outlined above, BP decided to install a 9-7/8-in. x 7-in. long-string production casing to a depth of 18,304 ft.¹⁰ While the long string satisfied the conditions experienced prior to and during the well-control incident, the combination of the long string with the stringent limits on allowable pressure limits against the formation during its installation drove the cement design to be very complex. BP relied upon a Halliburton OptiCem model that predicted a maximum 14.58-pounds-per-gallon (ppg) equivalent circulating density (ECD), indicating that it would be possible to obtain a good cement job.¹¹

As part of its examination, the investigation team commissioned Stress Engineering Services (SES) to analyze the long-string design. See *Appendix B*.^{12, 1}

Casing Design Conclusions

The investigation confirmed that BP's long-string design met the loading conditions that were experienced prior to and during the well-control incident. The use of this design, however, drove other plan departures that ultimately increased risk and contributed to the incident. Primarily, the decision resulted in the use of a complex, small-volume, foamed cement program required to prevent over-pressuring the formation during cementing. The plan allowed little room for normal field margin of error; it required exact calculation of annular volume and precise execution in order to produce an effective barrier to the reservoir.

The operator had other viable abandonment alternatives to either install a liner and tie-back or defer the casing installation until the future completion operations began.⁴ Both would have placed additional and/or different barriers in the well prior to the negative pressure test and displacement.¹³ The latter would have allowed additional time for planning and verification of the abandonment plan risks.

3.1.3 Casing Centralization

The production casing string was run into the Macondo well on April 18–19, 2010.¹⁴ Six centralizers were pre-installed with some of the casing joints. This was significantly fewer than the 21 centralizers recommended to prevent a high risk of gas flow, according to the third-party cementing specialist, Halliburton.¹⁵ The BP engineering team leader and drilling manager acknowledged that “we need to be consistent with honoring the model” that was the basis for the final decision on installing the long string rather than the liner. Fifteen additional centralizers were sent to the rig earlier in order to have the proper amount recommended by the Halliburton model. It would have taken approximately 10 hours additional time to install the 15 centralizers.¹⁶ Ultimately, BP decided to run only the six centralizers on the lower interval of the production casing string, despite the calculated heightened risk of channeling.¹⁷

Centralization above the productive formations was poor and, therefore, gave an increased probability of channeling contamination. However, the operator never performed any cement evaluation logs, so it cannot be confirmed whether centralization was adequate to achieve a good cement barrier around the casing annulus and across the reservoir formations.

I The SES analysis was limited to conditions such as tensile load, burst, and collapse pressures that likely would have occurred during the production casing installation, as well as likely conditions during procedures following the installation, such as the casing tests and those that would be experienced when the well was flowing.

J See 30CFR250.1714-21 MMS regulations for abandonment.

WHAT IS CENTRALIZATION?

A centralizer is a piece of hardware fitted onto casing strings and liners to help keep the casing in the center of the bore hole prior to and during cementing operations. See *Figure 7*. Centralizers are critical to ensure that a good cement sheath exists around the circumference of the casing or liner. They reduce the risk of the cement contamination and channeling, mitigate the possibility of gas migration, and help prevent differential sticking of the casing.

Cement channeling is the process by which cement travels the path of least resistance in the wellbore, leaving the side of the casing that has not been well centralized and is resting on or close to the wellbore without a good cement sheath around it. As the stand-off from the wellbore decreases, the average velocity required to initiate the flow of fluid in the narrowest part of the annulus increases. This makes it difficult to displace mud with spacer and cement and can result in contamination.

Even in a completely vertical hole, a casing string will not seek the center of the hole and requires hardware to centralize it. *Figure 8* illustrates the difference between not having centralization (0% stand-off) and having perfect centralization (100% stand-off).



Figure 7 Centralizer Sub

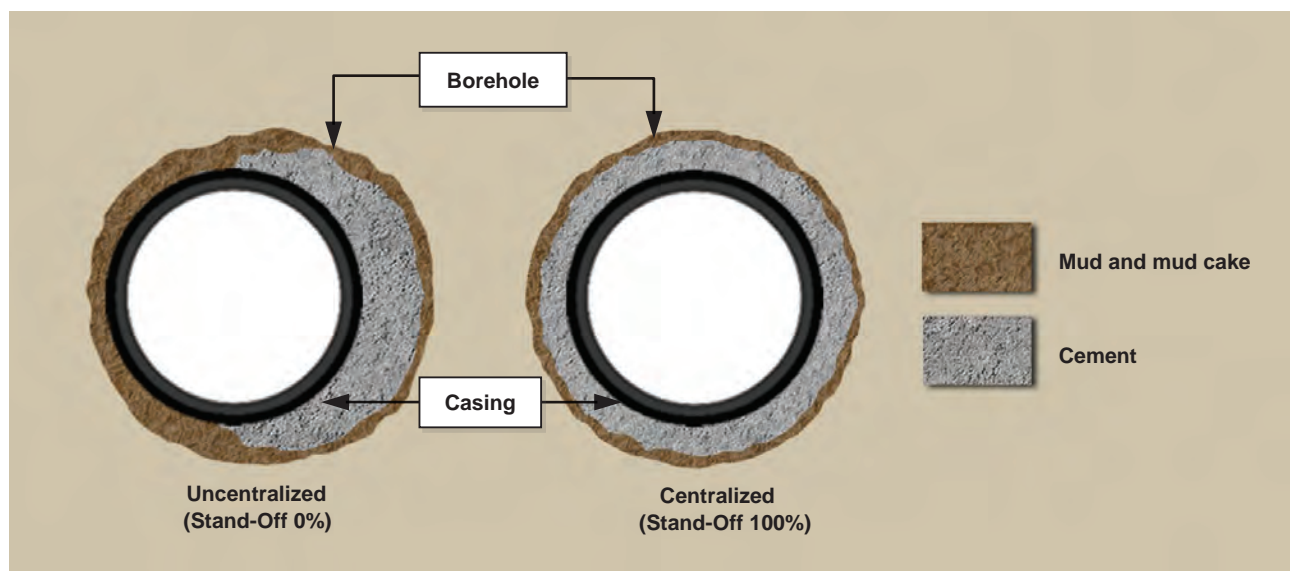

Figure 8 Poor Centralization (0% Stand-Off) versus Good Centralization (100% Stand-Off) of Casing

See *Appendix D* for a more detailed discussion of the centralizers and the altered centralization plan.

3.1.4 Conversion of the Auto-Fill Float Collar

The Macondo well plan called for the use of a surge reduction system on the production casing string to protect the formation from pressure surges that occur when casing is lowered into the well.¹⁸ A key component of this system was an auto-fill float collar manufactured by Weatherford. The float collar is installed at the top of the shoe track to prevent the cement from flowing back from the outside of the casing to the inside of the casing when the pumping stops. *Figure 9* shows an example of a casing shoe track. While the float collar is run into the well, the two flapper valves on the float collar are held open by an auto-fill tube. These valves reduce surge pressure by allowing the fluid in the well to flow through the device and up the casing, where a diverter tool feeds it up to the riser annulus.¹⁹

Once the casing string is in position, the float collar is converted (or closed) so that it serves as a one-way valve that allows only downward flow and prevents fluids from flowing up the casing string. Prior to converting the float collar, however, the diverter tool must be closed and tested.

Diverter Tool and Diverter Test Device (DTD)

The diverter tool is located above the casing hanger running tool. After the production casing was run to a depth of 18,304 ft. on April 19, 2010, the diverter tool was closed by inserting a 1-5/8 in. diameter brass ball into and down the drill string to a seat in the diverter tool. A pressure of 1,000 psi was then applied to the drill pipe.²⁰ This pressure activated the shear pins holding the diverter tool sleeve, which shifted the sleeve down, isolating the circulation ports and closing the diverter tool.²¹ Pressure was then increased to 2,433 psi to push the ball through the diverter sub-ball seat, allowing it to free-fall to the diverter test device (DTD), located approximately 300 ft. below the diverter tool. Pressure was then further increased to 2,765 psi, to confirm that (1) the diverter tool ports had closed, and (2) the DTD seat had sheared and the ball had free-fallen to the float collar located 189 ft. above the casing shoe.²² The investigation team concluded that no problems were encountered during the conversion and test of the diverter tool. *Figure 10* shows the pressures for conversion of the diverter tool and verification with the DTD.

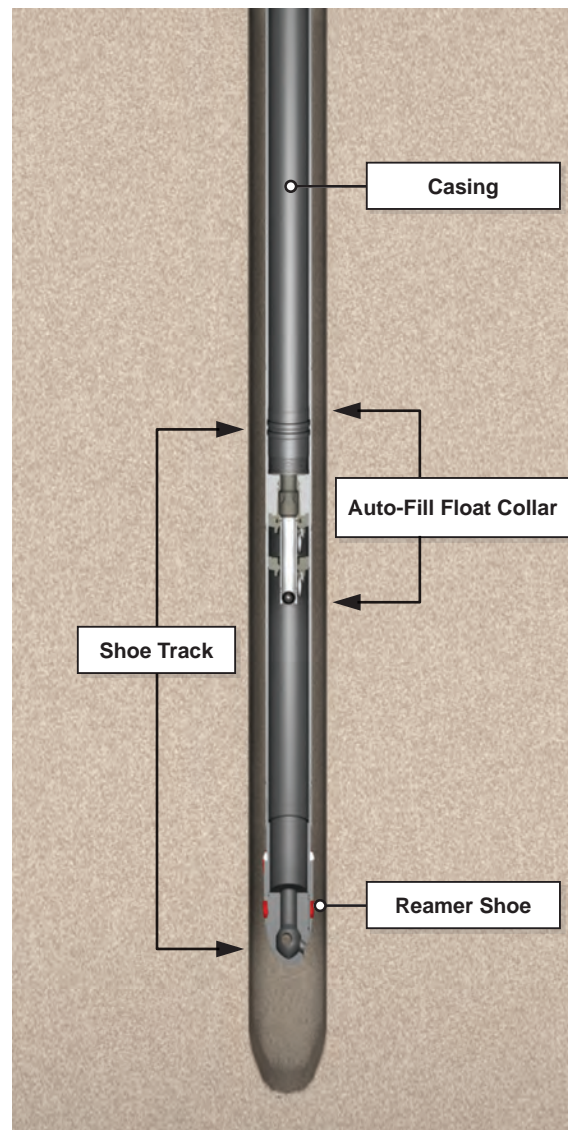

Figure 9 Example of Casing Shoe Track

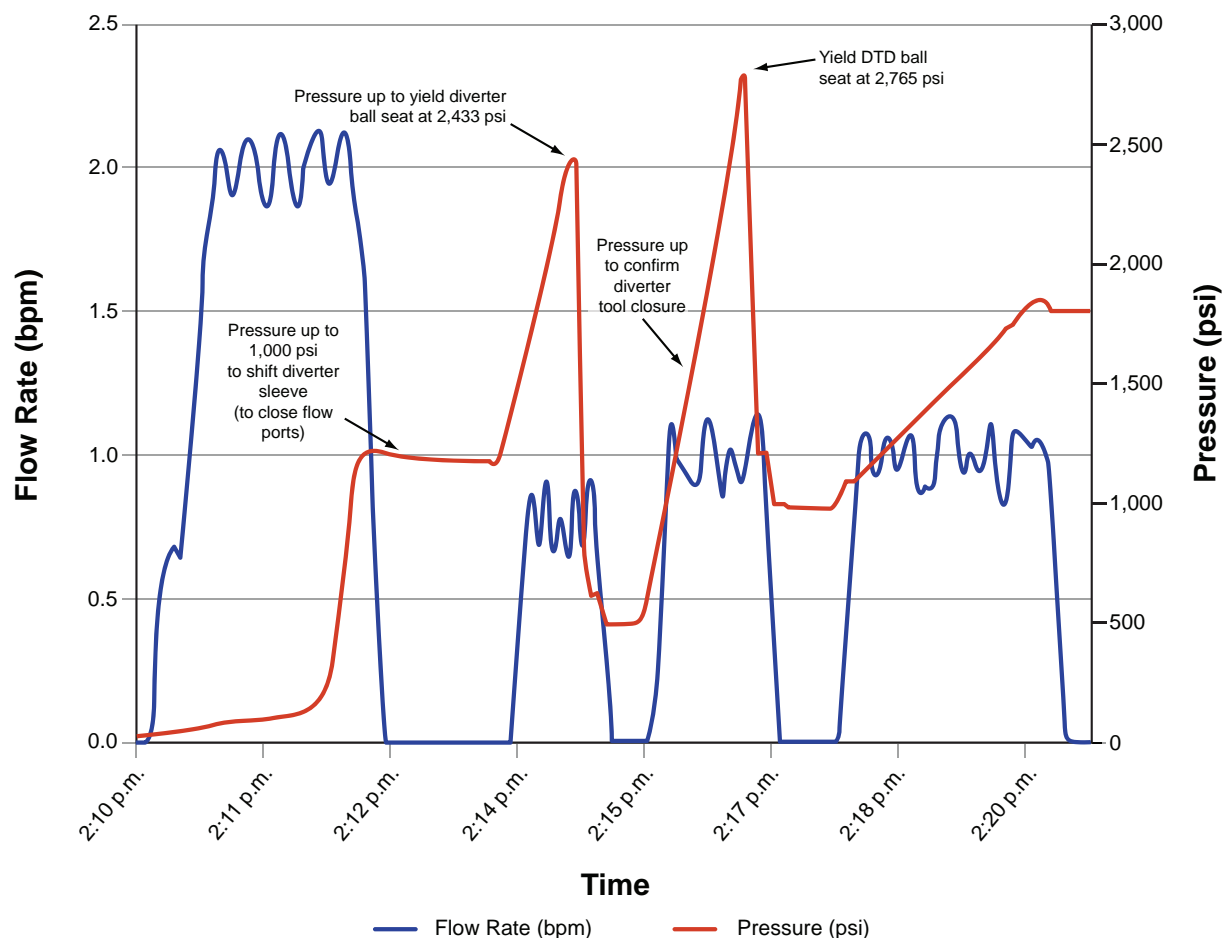

Figure 10 Conversion of Diverter Tool (to Closed Position) and Test with DTD (April 19, 2010)

Auto-Fill Float Collar

Auto-fill float collar conversion occurs when fluids are circulated to exert sufficient pressure to remove the auto-fill tube. This triggers the flapper valves to close. An actuating ball is seated at the base of the tube immediately below two small circulating ports. The ports allow drilling fluids to circulate through the auto-fill tube, which creates differential pressure between the top and bottom of the ball. Once the circulation rate is high enough to create sufficient pressure against the ball, the auto-fill tube is forced out, the spring-loaded flapper valves close, and full circulation is established with the check valve fully functional. See Figures 11 and 12. Conversion of the float collar is critical to ensuring the cement barrier holds and fluids are not allowed to flow up the casing string.

The conversion procedure was carried out the day before the incident. The operator's planned procedure was to slowly increase pump rates to greater than 8 barrels per minute (bpm) to convert the float.²³ This was consistent with the Weatherford published conversion rates and pressures of 5–8 bpm and 500–700 psi.²⁴ However, the BP well team deviated from the plan and decided to circulate at only 1 bpm due to concerns about the weakness of the formations.^K

K The sixth attempt to convert the float collar was at a rate of 2 bpm.

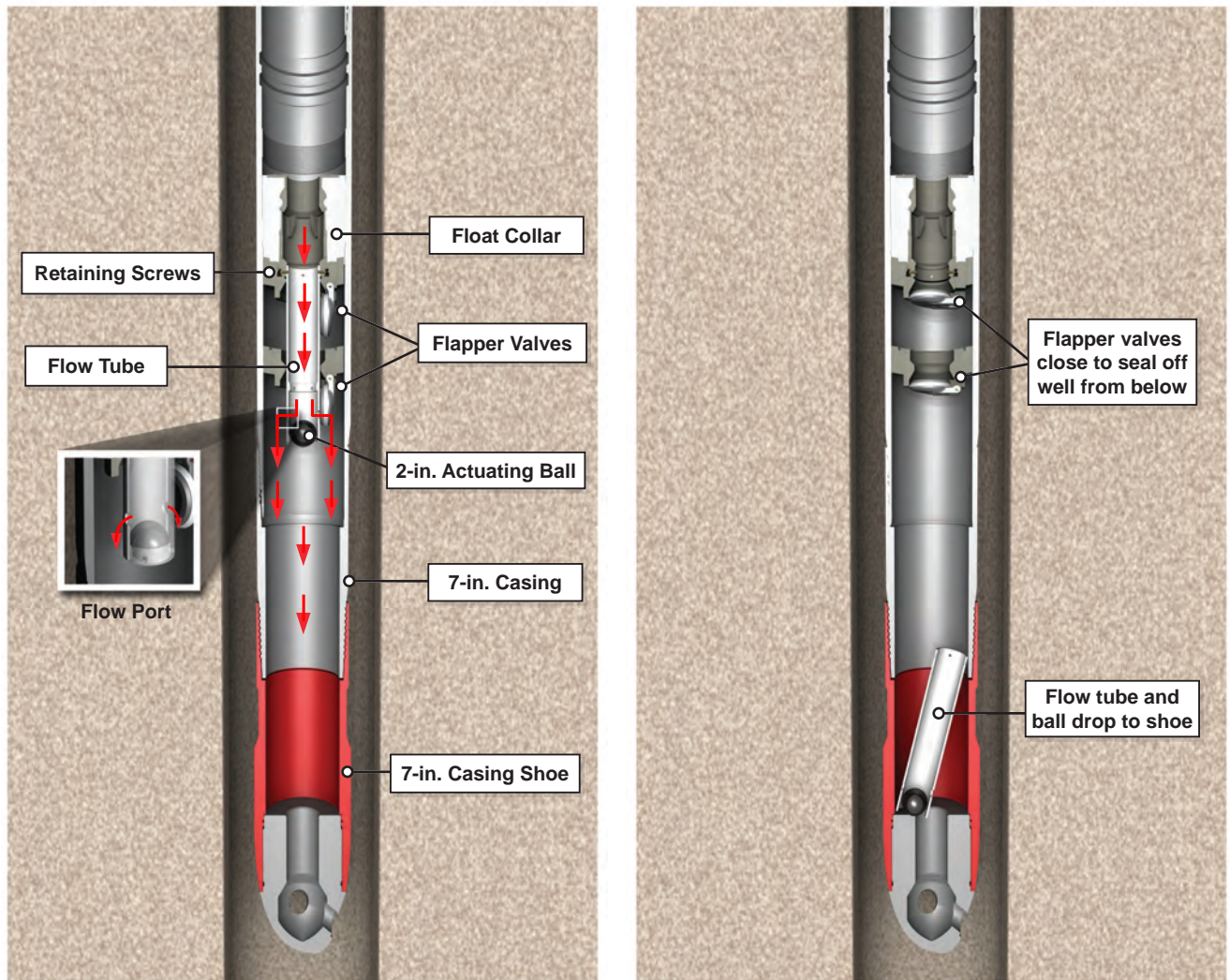

Figures 11 and 12 Casing Shoe and Auto-Fill Float Collar (Pre- and Post-Conversion)

There were a total of nine attempts to convert the auto-fill float collar, as can be seen in *Figure 13*:²⁵

- 1st attempt: Pressured up to 1,845 psi at 1 bpm and bled pressure off fast
- 2nd attempt: Pressured up 1,900 psi at 1 bpm and bled pressure off fast
- 3rd attempt: Pressured up to 1,997 at 1 bpm, held at 1,950 psi, and bled pressure off
- 4th attempt: Pressured up to 1,998 at 1 bpm, took 6.7 barrels (bbl), held 1,940 psi, and bled pressure off
- 5th attempt: Pressured up to 2,006 psi at 1 bpm, took 6.6 bbl, held 10 minutes, and bled pressure off
- 6th attempt: Pressured up to 2,004 psi at 2 bpm and bled pressure off
- 7th attempt: Pressured up to 2,255 psi at 1 bpm, took 7.3 bbl, and bled pressure off fast
- 8th attempt: Pressured up to 2,507 psi at 1 bpm, took 7.8 bbl, held at 2,450 psi, and bled pressure off fast
- 9th Attempt: Pressured up to 2,750 psi at 1 bpm, held for 2 minutes, increased pressure to 3,000 psi, held for 2 minutes, and sheared/apparently converted at 3,142 psi

BP never instructed the drill crew to pump at more than 2 bpm, despite its own procedure calling for 8 bpm.

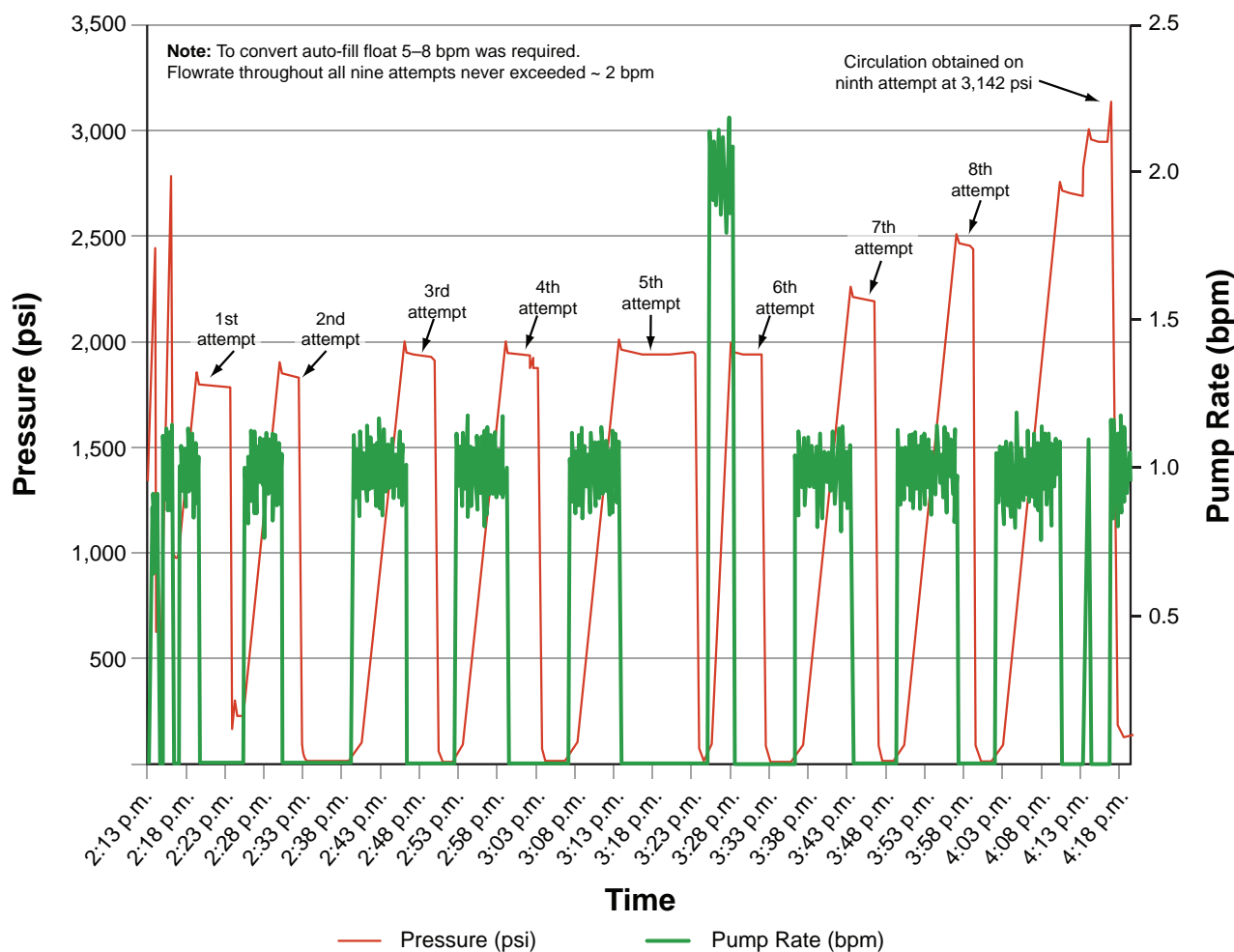

Figure 13 Nine Attempts Prior to Assumed Conversion of Auto-Fill Float Collar (April 19,2010)

The first attempt to convert the float collar at the lower flow rate of 1 bpm failed to establish circulation. Instead, the pressure rose to 1,900 psi, indicating that debris or formation cuttings likely were blocking the drilling fluid from flowing through the float collar. During subsequent attempts, the BP well site leader and engineer called shore for approval from the BP onshore supervisor to increase pressure to 2,200 psi, then 3,000 psi, and finally 3,500 psi.²⁶ While pressure was increased with each successive attempt to convert the float collar, the BP onsite engineer contacted the onshore Weatherford representative, who informed him that the actuating ball would go through the tube but would not actually convert the floats if the pressure reached and exceeded 1,300 psi. There was no Weatherford representative on the rig dedicated to supervising the conversion process. However, an Allamon diverter tool representative familiar with the equipment was onboard and recommended procedures to convert the equipment.²⁷

When the drill crew finally established circulation on the ninth attempt, with a pressure of 3,142 psi²⁸ and a pump rate of 1 bpm, the BP well site leader interpreted the break in pressure as evidence of a successful conversion.²⁹ The circulation for the cementing job was then raised to 4 bpm. However, when circulation was obtained, the pressures on pump 4 were lower than the Halliburton model predicted.³⁰ At 4 bpm, the model predicted 570 psi, but the actual pressure was only 350 psi. Circulation then was initiated using pump 3, but the pressure still was abnormally low at 390 psi at 4 bpm.^{31, L} The BP well site leader discussed the concerns over low pressure with BP onshore well management, but they ultimately decided to proceed with the cementing.³²

L Bob Kaluza stated pump 3 was used before switching to pump 4, but the data shows that pump 4 was used first before switching over to pump 3.

Post-Incident Float Collar Testing

As part of the investigation, the team ran a series of tests on two 7-in. Weatherford float collars similar to the one run by BP on the Macondo well.^M SES ran four tests on these collars. The purpose of the tests was to identify potential failure points that may occur under a pressure of 3,142 psi. Details of the float collar testing can be found in *Appendix C*.

The first test checked the pressure at which the float collar normally would convert. A load was applied to the conversion ball at the seat position in an attempt to force the failure of the retaining screws and thus activate the floats. The screws did not fail; instead, the collar holding the screws in place failed under the applied load. The collar failure occurred at almost the same pressure on both floats tested: 410 psi and 406 psi, respectively. See *Figures 14 and 15*.



Figures 14 and 15 Flow Tube Damage During “Normal” Float Conversion Test

The second test checked the pressure at which the ball would be ejected from the tube (i.e., the pressure at which the ball seat in the tube would fail), and thus prevent the float collar from converting. The tube was installed in a plate and glued in place, and a load was applied to the 2-in. ball until it broke through the smaller 1.93-in. seat. The ball broke through at 1,477 psi on the first float and 1,840 psi on the second. This generally confirms the Weatherford representative’s assertion that the setting ball would pass through the tube without converting the floats if the pressure reached or exceeded 1,300 psi.³³ See *Figures 16 and 17*.



Figures 16 and 17 Actuation Ball Ejected Through Seat of Flow Tube

^M These two float collars, while similar, were not identical to the one installed on the Macondo well, nor to the float collars subsequently tested by BP.

The third test checked the float valve flappers designed to keep the cement in place with synthetic oil-based mud.^N The test assessed how much pressure the flappers could withstand from the underside of the float valves before providing a leak path for fluid from below to above the valve. The flappers were tested first at ambient temperature to 500 psi. Then they were heated to 225°F and tested again to 3,000 psi. Both floats held at these pressures and temperatures.

In the fourth test, the internal flapper assembly was exposed to a load from above to check the pressure required to cause the failure of the internal assembly, which was threaded into the collar. In this scenario, only one float was tested. It took a total of 10,155 psi (or 81,800 lb.) to cause the assembly to fail at the threaded connection. See Figures 18 and 19.

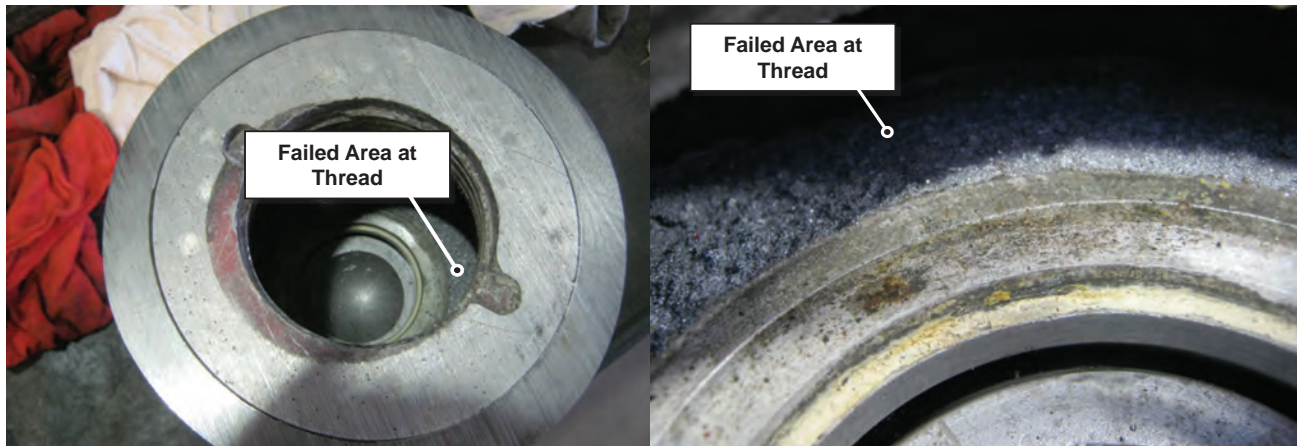

Figures 18 and 19 Damaged Internal Float Assembly

Float Collar Conversion Conclusions

The investigation team's testing of 7-in. Weatherford float collars confirmed the following:³⁴

- The float collar sleeve functioned properly at the pressure designated by the manufacturer (test results of 410 psi and 406 psi). The failure point in the system was not the retaining screws; rather, it was the collar holding the retaining screws that failed under the load.
- The actuating ball was ejected from the seat near the Weatherford reported pressure rating of 1,300 psi (test results indicated 1,477–1,840 psi). The failure point was identified as the flow tube ball seat.
- The double flapper valves that close upon sleeve actuation held 3,000 psi of fluid pressure from below once properly converted.
- It is unlikely that the application of 3,142 psi of pressure during conversion attempts caused damage to the internal float flapper assembly. Tests demonstrated that 10,155 psi was required to cause such a failure.^O

Given these results, the investigation team was unable to confirm which failure mode occurred with the auto-fill float collar. The investigation team believes that BP's decision to limit circulation while running casing could have resulted in wellbore debris plugging the shoe-track assembly and float collar, which prevented the drill crew from establishing circulation during its initial attempts to convert the float collar. The excessive pressure increase to 3,142 psi may have unblocked the system, allowing circulation to be established. The investigation team believes that the ball may have been ejected from the ball seat without converting the float collar given the pressures that were applied.

^N The investigation team used 12-ppg synthetic oil-based mud for the tests.

^O The 10,155 psi test pressure was applied below the float collar while the 3,142 psi was applied from above.

3.1.5 Production Casing Cement Design

As a drilling contractor, Transocean does not possess expertise in cementing and was not party to decisions regarding the design of the cement program at Macondo. The drill crew relied on BP and Halliburton to ensure that the cement program was appropriate and that all testing had been completed before cementing operations began.

The Transocean investigation team engaged external industry experts. Because the team was not provided samples of or access to the Halliburton cement formula, it relied upon the results of the testing of that material performed by Chevron for the President's National Oil Spill Commission.

The investigation team's technical analysis of the cement program independently reached many of the same conclusions as the evaluations performed by Chevron for the President's National Oil Spill Commission and CSI for BP's internal investigation report. Specifically, the investigation team concluded that the precipitating cause of the Macondo incident was the failure of the cement in the shoe track and the primary cement across the producing formations, which allowed hydrocarbons to flow into the well and to the rig. The failure was the result of a number of factors:

1. The wellbore was inadequately circulated prior to the cement job.
2. The cement program was overly complex to prevent losses to the formation.
3. The cement slurry was inadequately tested prior to the job.
4. There was no post-job verification of cement properties (e.g., setting time, compressive strength, etc.).

The investigation team found no evidence that either Halliburton or BP exercised the necessary diligence regarding the testing and implementation of the cement program, despite their awareness of the inherent difficulties and risks of the program.

1. Inadequate Circulation of the Wellbore Prior to Cementing

During a full "bottoms-up" circulation, all of the existing mud in the wellbore is displaced with fresh mud. Circulating fresh mud throughout the wellbore before cementing removes unwanted debris and conditions the mud. The American Petroleum Institute (API) recommended practice suggests circulating a full bottoms-up prior to cementing. BP did not perform a full bottoms-up before cementing on April 19, 2010, and the drilling mud in the well had not been circulated for more than three days.³⁵

BP's original drilling program called for circulating the minimum bottoms-up operational standard: 1.5 times the drill pipe and casing volume, which at Macondo would be 1,315 bbl.^{36, P} A full bottoms-up would have required approximately 2,750 bbl and would have taken about 11.5 hours. In the end, due to concerns about the fragility of the formation, BP decided to circulate only 346 bbl, far less than a full bottoms-up.³⁷

On April 15, 2010, the drill crew performed a "cleanout trip," which circulates the mud, and verified that the wellbore was in good condition.^{38, Q} No problems were encountered during this process; this suggests that the operator could have performed a full bottoms-up circulation and improved the probability of obtaining a successful cement job.

2. Complexity of Cement Program

BP directed Halliburton to develop a program to cement the long-string production casing without fracturing the formation.

P One-and-a-half (1.5) times the internal drill pipe and casing volume is a minimum operational standard. In order to ensure there is no debris inside the casing or landing string that could inhibit the proper circulation of cement, a full internal volume plus some safety factor (e.g., 50%) should be pumped prior to commencing the cement operations.

Q Also known as a "conditioning" trip, a cleanout trip is made after logging operations and prior to running casing in the hole. This is to ensure the hole is in good condition and casing can be run to bottom as the logging operations typically can be from two to five days, or longer.

To achieve this, Halliburton proposed a program that:

- Used a nitrified cement slurry to obtain the desired lower density, thus increasing technical complexity
- Employed a small overall volume of cement, diminishing the margin for error in cement placement and increasing the negative impact of small amounts of contamination
- Pumped the cement at a rate lower than that required for optimal mud removal (*See discussion on “Displacement” that follows*)

This compounded the difficulties already posed by cementing a long string at Macondo, including:

- A greater risk of contamination, as a small amount of cement would be pumped down a longer amount of casing
- The inability to rotate or reciprocate a long string during cementing
- Increased difficulty in performing repairs
- The need to minimize frictional pressures, which increased procedural complexity

This program left little room for error in both the slurry design and the implementation of the cement program.

3. Cement Slurry Design

Halliburton formulated a cement program for Macondo that injected nitrogen foam into a cement base slurry to lower its density and thus the pressure on the fragile formations. The 16.74-ppg base slurry also contained silica flour and sand to prevent the cement from weakening when it encountered high temperatures downhole, as well as a liquid retarder and other additives to increase thickening time.³⁹ This base slurry was to be pumped both in front of and behind the foamed slurry to act as a “cap” and a “tail.”

This program was one of two specified in Halliburton’s cement lab test results dated April 12, 2010.^{40, R} An evaluation of the base slurry constituents highlighted the following:

- Anti-foaming agents are not compatible with foamed cement, as they can act as a destabilizing agent. There is no evidence that use of D-Air products in foamed cement slurry is recommended by Halliburton in its Foam Cementing Operations Manual. Therefore, the antifoaming agent (D-Air 3000) should not have been included in the slurry without performing extensive laboratory testing.
- Potassium Chloride (KCl) also was an ingredient in the slurry recipe. It has the potential to destabilize foam cements.
- No fluid loss additive was included in the base slurry to help prevent gas migration.
- Uneven distribution of the silica and sand can cause changes in the cement-to-silica ratio when mixing “on the fly” through the re-circulating mixer, as opposed to mixing in a batch blender, which Halliburton did not have on the rig. Changes in the cement-to-silica ratio of the dry-blended cement can alter the retarder-to-cement concentration and modify thickening time and compressive strength development.^S

4. Cement Slurry Testing

Testing on the production casing cement slurry used at Macondo was inadequate. The investigation team found no evidence of several laboratory tests that should have been conducted by Halliburton, nor is there evidence that the operator requested such information before proceeding with cementing operations. Testing of the slurry had begun as early as Feb. 10, 2010, but by April 19, 2010, when the job was performed, Halliburton still lacked valid crush compressive strength results for the foamed cement slurry being used. The investigation team believes that the cement most likely was not set at the time of the blowout due to one or more of the following reasons:

R The second lab test had 0.09-gps liquid cement retarder, as opposed to 0.08 gps. An e-mail from the BP well team instructed the use of 0.09-gps liquid retarder instead of 0.08 gps to give a longer pump time. However, several of the test results pertaining to the 0.08-gps retarded slurry were not repeated..

S Weigh Up Sheets from several lab tests prior to the incident noted the total silica ratio (silica flour plus 100 mesh sand) was 35.000%. The samples tested were noted to be from dry blended cement samples from the rig.⁴¹

- Higher-than-required concentration of retarder (agent to slow cement thickening time)⁴²
- An inverted thickening time effect of the retarder on the cement at setting temperature which would result in an increased thickening time and therefore increase the required time to wait on cement^{43, T}
- Cement contamination with mud during placement or through the exchange of fluids between the shoe track and lower-density mud in the rat hole — the area of open hole between the end of the casing and the formation
- Insufficient time to allow the cement to set and to develop minimum compressive strength values⁴⁴

There was no information from any of the test results available at the time the cement was installed that gave clear guidance as to what amount of time would be required for the cement to be set.

Cement Program Tests

Temperature Simulation – Bottom Hole Static Temperature and Bottom Hole Circulating Temperature

Temperature simulations are prerequisites to a slurry testing program. Accurate estimates of the bottom hole static temperature (BHST) and the bottom hole circulating temperature (BHCT) are fundamental to proper laboratory testing. The temperature to which a slurry is exposed downhole will determine its behavior, including how long it will take to set. Halliburton's lab testing report contains mistakes in documenting the BHST, which raises questions about how the BHCT was calculated and recorded.⁴⁵

The BHST of the Macondo well was documented to be around 242°F, which normally would have been used as the basis for estimating the BHCT.^U There were inconsistencies noted in the BHST and BHCT values in Halliburton's various Production Casing Proposals.⁴⁶ The final lab test results set the BHST at 210°F and used a BHCT of 135°F for the thickening-time tests and some of the rheology testing.⁴⁷ If Halliburton had used a BHST of 242°F instead of 210°F to estimate the BHCT, it is logical that the BHCT for the cementing tests would have been higher than 135°F, possibly in the 150–170°F range.^V The investigation team found no evidence to date as to how Halliburton arrived at 135°F.

For a critical and complex cement program such as this one, a computer temperature simulation program should have been conducted to provide an accurate estimate of the BHCT at the time the cementing fluids rounded the shoe. It would also have provided the rate of temperature increase back to static conditions after pumping stopped with the cement in place.^W Additionally, a computer temperature simulation program would have provided an estimate of the cement temperature at the time of the blowout and would help determine, with further laboratory testing, whether the cement was set. An example of a typical temperature history graph is shown in *Figure 20*.⁴⁸

- T Chevron Cement Test Data Table 4 (p. 6) Protocol 2 indicates that at a temperature above 135°F and below the threshold temperature (to be determined), the thickening time increases. In this case, after three hours in the pressurized consistometer at 135°F, it took another 9 hr. 58 min. to "set" (i.e., reach 50 psi after heating up to 180°F in four hours). This is considerably longer than the 7 hr. 37 min.–8 hr. 20 min. for the thickening time at 135°F.
- U The BHST is the temperature of the undisturbed formation at the final depth in a well. The BHCT is derived from the BHST. It is the temperature of the circulating fluid at the bottom of the wellbore after several hours of circulation. This temperature is lower than the BHST.
- V Without a proper temperature simulation model, it is difficult to precisely determine BHCT. However, with a known BHST of 242°F, one could expect the BHCT to be somewhere within the 150–170°F range.
- W Such a mathematical computer simulation would include inputting the following data: complete well geometry; lithology; BHST, temperatures at surface, and temperatures and depths in sea and at sea bed; nature/rheology, volume and pump rate of the cementing fluids pumped; and nature/rheology, volume and pump rate of mud conditioning prior to cementation.

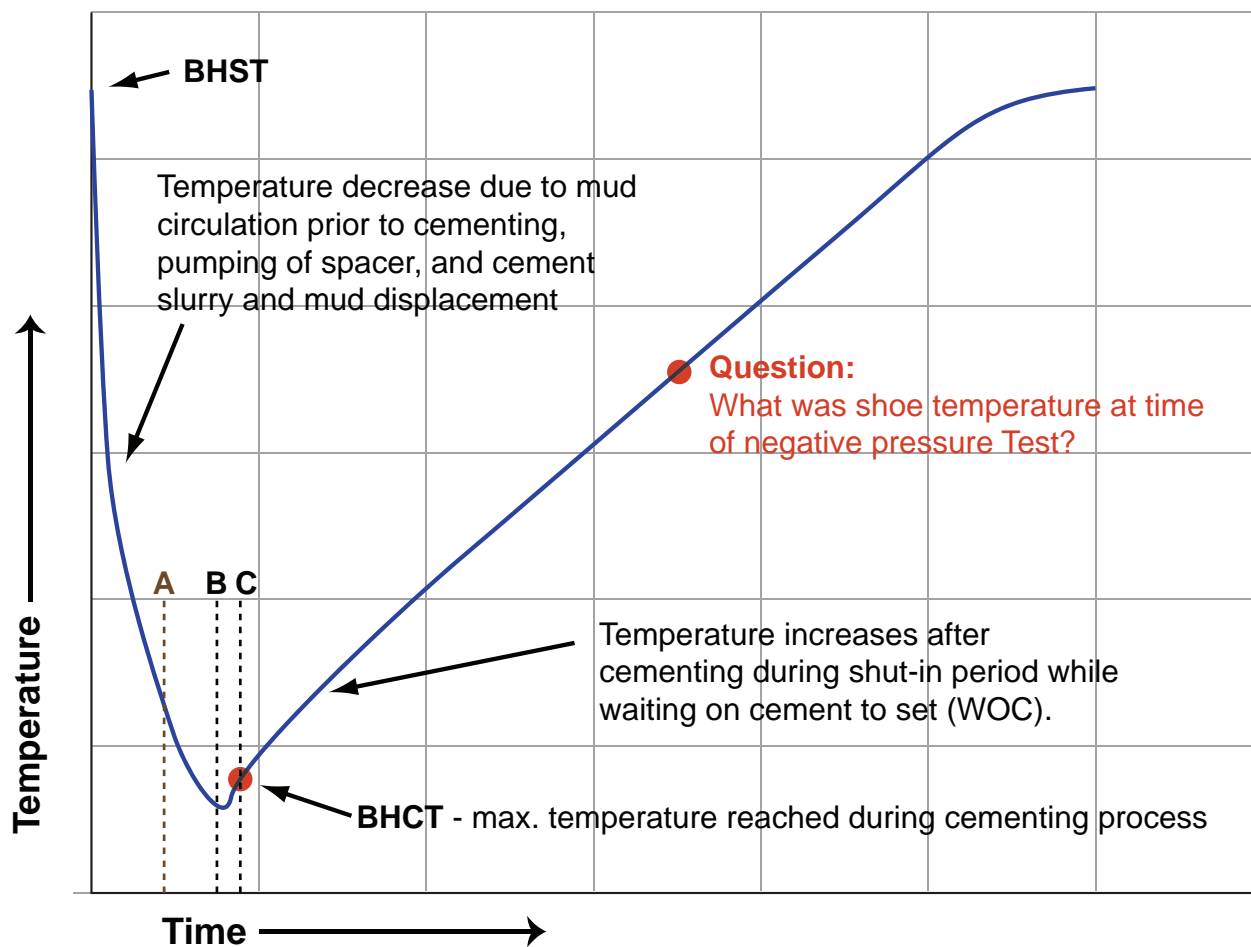

Time A: Conditioning mud starts to round shoe

Time B: Base oil followed by spacer and cement starts to round shoe

Time C: End of cement displacement; start of waiting on cement to set

Figure 20 Typical Temperature Trend Prediction of BHCT and Rate of Increase after Cementing (Not Representative of Actual Conditions at Macondo)

Retarders are chemical agents used to lengthen the thickening time for cement slurry to ensure proper placement. The required amount of retarder usually increases with depth because of the additional time needed to perform the cementing job and increased temperatures downhole. At lower temperatures (e.g., 160–190°F), retarders often have an inverted effect on the thickening time of certain cements. In other words, the thickening time increases rather than decreases as the temperature rises until the threshold temperature is reached; then transition from liquid to solid is rapid.^x

Extended thickening times result in delays in the development of the compressive strength of the cement and thus require additional time for the cement to set. If the cement was in the temperature range outlined above, it is likely that the cement would not have set when the well was subjected to the negative pressure test.⁴⁹ See *Chapter 3.2.3* for a complete discussion on the negative pressure test.

^x This phenomenon was documented by J. Benstead, BP Int'l Ltd., SPE23703, Retardation of Cement Slurries to 250°F. Four different types of API Class G Cements and four commonly used retarders at different combinations were employed to make slurries. Their thickening times were measured at seven different temperature schedules (125°F, 144°F, 165°F, 185°F, 206°F, 228°F, and 248°F) and five different increasing concentrations starting from 0 gps. The results showed that although there were differences in thickening times between the different cements and retarders, a clear threshold of unexpectedly longer thickening time was observed at approximately 160–190°F due to a surge in C4 AF reactivity, which impedes hydration of the main components of the cement (Alite and Calcium Silicate Hydrate).

Thickening Time Tests

Thickening time tests are designed to replicate the time that the slurry remains in a pumpable state under simulated temperature and pressure conditions in the wellbore. The amount of time it takes the cement to set normally is proportional to the concentration of retarder used. That means that an increase in retarder concentration will cause an increase in cement thickening time.

The thickening time test of the base slurry to 70 Bearden units of consistency (Bc) with 0.09-gallons-per-sack (gps) retarder concentration (the same concentration used on the job), at a BHCT of 135°F and 14,458 psi,⁵⁰ was 7 hr. 37 min.^{51, Y} An earlier thickening time test with a lower retarder concentration of 0.08 gps gave a thickening time of 5 hr. 30 min.⁵²

Post incident thickening time tests conducted by Chevron using the same 0.09-gps retarder concentration showed a longer thickening time of 8 hr. 18 min. for the slurry to reach 70 Bc, compared with the Halliburton lab test of 7 hr. 37 min.⁵³ Chevron's testing also was conducted at the same BHCT of 135°F used by Halliburton. (See earlier discussion on "Temperature Simulation.") This indicates that the true thickening time of the slurry may have been even longer, when considering the inverse effect of the retarder and the actual wellbore temperature.⁵⁴

It is good practice to vary the retarder concentration in testing by +/-5% to verify that the slurry design is robust and to account for field errors not exceeding +/-2.5%. The investigation team found no evidence that this was performed during the course of thickening time tests.

Ultrasonic Cement Analyzer (UCA) and Crush Compressive Strength Tests

Compressive strength tests, measured in pounds per square inch (psi), indicate the strength development of the cement under simulated downhole pressure and temperature conditions.

The UCA test performed by Halliburton for the base slurry with 0.09-gps retarder at 210°F showed a compressive strength of 2,966 psi after 24 hours.⁵⁵ Because it was, and remains, unknown that temperatures of 210°F would have been reached within the time period of the negative pressure test, these tests should have been run at a lower temperature.⁵⁶ A temperature simulation modeling the increase in temperature after cementing would have been useful in selecting the appropriate UCA test temperature and temperature ramp-up schedule.

The last known completed crush compressive strength test reported for the foamed slurry, dated April 12, 2010, was conducted at 180°F with a lower retarder concentration (0.08 gps) than was used on the job.⁵⁷ It showed a 24-hour compressive strength of 0 psi. Halliburton presented the 0.08-gps retarder compressive strength results in the primary lab results for 0.09-gps retarder concentration. The higher retarder concentration actually used on the job would have delayed the compressive strength development even longer. Since the negative pressure test procedure was performed approximately 17 hr. 50 min. after the cement was in place, it is unlikely from these results that the foamed cement was set.⁵⁸

Correspondence between BP and Halliburton at 8:58 p.m. on April 18, 2010, noted that another compressive strength lab test was being conducted on the slurry and that the lab test still had 14 hours left before results could be reported. The BP well team began cementing operations on April 19, 2010, at approximately 7 p.m., less than 24 hours after the aforementioned correspondence from Halliburton.⁵⁹ There is no evidence that the BP well team confirmed the results of these lab tests before proceeding with cementing operations.⁶⁰

A lab test for foamed crush compressive strength dated April 16, 2010, was cancelled before the results were reported. This suggests that a foam crush compressive strength test was never completed by Halliburton with the actual retarder concentration that was pumped into the well.

Y It is not clear why Halliburton selected 14,458 psi for its thickening time and ultrasonic cement analyzer (UCA) testing, when the highest pressure reached during circulation was 14,087 psi (HAL_0011005). Static end-of-job pressure at TD was 13,506 psi (HAL_0011009). The lower pressure probably would be more appropriate for UCA compressive strength testing. At 70 Bc, the slurry is considered as being un-pumpable. Thickening time is measured in Bearden units of consistency (Bc), a dimensionless quantity with no direct conversion factor to more common units of viscosity.

Thus, at the time of performing the negative pressure test, BP should have been aware that:

- Foamed cement cured at 180°F with less retarder (0.08 gps) would not be set in 24 hours.
- If heated from 135°F to 210°F in four hours (after conditioning the slurry for three hours), the base cement would set with a strength of 500 psi at 210°F in 8 hr. 40 min., with the same retarder concentration of 0.09 gps.

Without a computer temperature simulation to indicate the time that it would take for the wellbore annulus to reach 210°F, an informed decision could not be made on how long to wait for the cement to be set before safely attempting a negative pressure test.⁶¹

Chevron attempted to replicate the crushed compressive strength values reported in the Halliburton lab results but was unable to do so because the foamed slurry was unstable.⁶²

Fluid Loss (No Evidence of Test)

This test is designed to measure the slurry dehydration during and immediately after placement of the cement. There is no evidence that any fluid-loss testing was conducted for the production casing cement slurry. Halliburton noted in its Sept. 26, 2010, presentation that fluid-loss testing typically is not performed with foamed cement slurries.⁶³ While foamed cement is known to exhibit some relatively good fluid-loss properties, the un-foamed base cement used for the cap and tail portion of the cement design would have poor fluid-loss properties since there was no fluid-loss additive in the base slurry design.

High-pressure/high-temperature (HPHT) testing done by Chevron (with Halliburton additives) in accordance with API showed fluid loss to be even worse at 578 mL/30 min. and 456 mL/30 min.⁶⁴ This is well above the maximum limit of less than 50 mL/30 min. for critical cementation where severe gas potential has been identified.^{65, 66} The investigation team concluded that the production string cement had poor fluid-loss characteristics.

Free Fluid (No Evidence of Test)

This test assesses the slurry for stability at downhole temperature before it sets. The ability of water within the slurry to separate from the slurry can result in channeling and the potential for gas to migrate upward to another zone or to the surface. No free-fluid testing was reported on the slurry for the Macondo production casing by Halliburton.

Critical cement slurry test results should range from zero to only a trace of free fluid. Two Chevron free-fluid tests, after HPHT conditioning of the slurry, showed free fluid varying from 0–1.6% in a vertical sample.^{67, 2} Therefore, the tests should have been repeated to determine which one was the valid test.

Static Gel Strength (No Evidence of Test)

This test measures the transition of cement slurry from its liquid state to a set state under the downhole slurry conditions. There is no evidence that Halliburton conducted static gel strength tests on the production casing cement slurry.

Static gel strength tests conducted by Chevron were at the same temperature reported in Halliburton lab tests. It showed a transition time of 1 hr. 26 min. for the gel strength to increase from 100 pounds-force (lbf)/100 ft² to 500 lbf/100 ft². A transition time in excess of one hour generally is not considered adequate for gas migration control. Tests were conducted at an estimated BHCT of 135°F, which likely was not representative of the downhole slurry temperature as discussed earlier.⁶⁸

Rheology

Rheology is the study of the flow and deformation of fluids in response to an applied stress. It describes the relationship between flow rate (shear rate) and pressure (shear stress) that induces movement. From rheological measurements of each fluid pumped (mud, base oil, spacer, base slurry, foamed cement), slurry

Z The Macondo wellbore was a vertical design.

placement may be optimized for good mud removal and friction pressures quantified within the casing and annulus to maintain safe operating conditions.

Foamed cement rheologies cannot be measured with standard API-recommended laboratory equipment. Therefore, the base slurry rheology normally is substituted. It is known that low-foam-quality slurry has less viscosity than the base slurry, and viscosity increases as the foam quality increases from 10–30%.⁶⁹

Best practices dictate that all the fluids, whenever possible, are tested at the BHCT (in this case 135°F), in order to correctly program the cementing simulator (OptiCem).

The tests in Halliburton's April 18, 2010, report on the mud, spacer, base oil and foamed slurry were carried out at various temperatures.⁷⁰ API rheology of the base cement slurry was conducted at 80°F and 135°F, respectively. These results were reported in the primary lab results.⁷¹ Temperatures used to evaluate the mud, spacer and base-oil rheologies varied anywhere from 40–150°F.⁷² The lab results on April 12, 2010, assumed a BHCT of 135°F.⁷³ The same temperature should have been used for all rheology tests of fluids.

Rheology testing performed by Chevron on the slurry showed results similar to those reported by Halliburton when the slurry was heated to 80°F without conditioning, and at 135°F with 30 minutes of conditioning.⁷⁴

Based on the lab test results by Halliburton and confirmed by CSI Technologies and Chevron, it appears the yield point value for the base slurry was too low (2 lbf/100ft²) as yield points above 5 lbf/100ft² are recommended for generating stable foamed slurries.⁷⁵

Foam Mix and Stability Test

Foam mixability tests determine how long the slurry takes to foam at atmospheric conditions. Stability tests are to ensure that gas does not break out of the slurry during and after placement. Foamed slurries need to be stable for a period longer than the time required for the cement to set.

The April 12, 2010, lab test showed that the time it took for the slurry to foam was eight seconds, which is within API requirements of 15 seconds or less.⁷⁶ The lab test also identified no existence of a density gradient between the top and bottom evaluated sections of the test slurry. The test slurry was reported at an incorrect density of 1.8 specific gravity (15 ppg). The foamed slurry was designed to a density of 14.5 ppg (0.5 ppg less than the test sample).⁷⁷

As for the foam crush compressive strength test, a lab test for foam stability dated April 16, 2010, also was cancelled before the results were reported.

Laboratory testing performed by CSI Technologies for the BP internal investigation using replica slurry concluded that the slurry could not be foamed with a single blade assembly above 50% foam quality at atmospheric pressure at 110°F and 140°F. The foamed slurry generated at 18.5% foam quality also was unstable at these conditions.⁷⁸

Various tests run by Chevron also were unable to obtain a stable foamed cement using the same design parameters, cement, and additives as the Halliburton production casing slurry.⁷⁹

Fluid Compatibility Test (Spacer, Mud, and Cement)

These tests identify the effect of the interaction between the drilling fluid, cement, and spacer, which is particularly important when using oil-based mud, as it can destabilize foamed cements. The procedures test the effects of spacer on the behavior of the cement slurry and drilling fluid.⁸⁰

While there is evidence of tests performed to assess the compatibility of the mud and spacer, no evidence of compatibility testing for mud spacer and cement slurry was found. The density and rheologies of the mud and spacer samples used for compatibility testing differed from the actual mud and spacer utilized for the cementing program at Macondo.⁸¹

Testing conducted by Chevron on slurry contamination with mud determined that the final sonic strength of the cement slurry decreased as drilling fluid contamination increased. However, the time required to reach the 100-psi sonic compressive strength was not greatly affected. Because stable foamed cement slurries could not be generated using the Halliburton recipe, Chevron could not perform contamination tests on the nitrogen-foamed portion of slurry.⁸²

Cement Design and Testing Conclusions

Halliburton failed to carry out all of the necessary testing per industry requirements for critical cementing operations, and BP failed to verify that all such tests had been performed before it started cementing operations. There also were errors in the design of the foamed cement slurry, including the use of de-foamer and the exclusion of fluid-loss additives in the base slurry.⁸³

- Evidence from post-incident testing performed by CSI Technologies on behalf of BP suggests the de-foamer had a negative effect on the foam stability. Without fluid-loss additives, the fluid-loss properties of the base slurry would have been significantly below the normally expected requirements. Other additives, such as potassium chloride salt, retarder, and bulk-flow enhancer also were deemed to have an adverse effect.⁸⁴ Evidence presented by Chevron from tests using representative samples confirmed that the slurry designed by Halliburton was unstable.⁸⁵
- The investigation team found no evidence that critical tests such as fluid-loss, free-fluid, and static gel strength tests were performed. Prior results with an incorrect retarder concentration (0.08 gps) were incorporated into the final results presented for crush compressive strength for the slurry that was actually pumped (0.09 gps). This gave inaccurate and misleading results.⁸⁶
- Lab test results stated BHST as 210°F and BHCT as 135°F. Documentation reviewed subsequent to the incident has shown the BHST to be 242°F.⁸⁷ Therefore, the BHST utilized for the cement testing was incorrect. This also makes suspect the BHCT value of 135°F.
- Temperature simulation is critical and should have been performed to enable accurate results for thickening time and compressive strength testing. Based on the documented BHST of 242°F, the cement in the well may have been in the temperature range of approximately 160–190°F, 17 hours after the cement was in place (at the time of the negative pressure test), which is the range at which retarded cements demonstrate unexpectedly longer thickening times. This is evidenced by the Halliburton UCA and crush compressive strength tests discussed previously. Ultimately, the lab test results did not give a clear indication of when the cement would set.
- Crush compressive strength tests still were being run by Halliburton 22 hours prior to cementing the production casing. Initial crush tests to determine compressive strength for the foamed slurry showed no compressive strength (0 psi) after 24 hours with less retarder than actually was used. The investigation team found no evidence to suggest that the BP well team had the final lab results for the compressive strength test before proceeding with cementing operations. The last crush compressive strength lab test was dated April 16, 2010, and was cancelled before the results were reported.

3.1.6 Cement Program Execution

Cementing operations on the production casing started at approximately 7 p.m. on April 19, 2010.⁸⁸ The cement was mixed and pumped from the Halliburton cement unit, then displaced with 132 bbl of mud from the cement unit to the point of releasing the top wiper plug, which separates the cement from the drilling mud while pumping down the casing.⁸⁹ Figure 21 shows an example of top and bottom cement wiper plugs. The remainder of the cement displacement was completed with the mud pumps on the *Deepwater Horizon*.⁹⁰

Displacement (Pumping Rates and Fracture Pressure)

When displacing cement, an optimal pump rate usually is calculated to achieve a maximum flow rate that will facilitate good hole cleaning and mud removal in the annulus space where cement will be placed, while not exerting excessive pressure on the formations. Typically, the pump rate is lowered near the end of displacement to reduce the friction pressures exerted on the formation by the dense, viscous cement in the annulus. The rate also is lowered to minimize sharp increases in pressure when the top wiper plug lands on the float collar, which is known as “bumping the plug.”

During the drilling of the final section of the well, BP correspondence noted that when picking up off bottom (lifting the drill string from the bottom of the well) with a 14.7-ppg equivalent circulating density (ECD) at 18,260 ft., the formations fractured and fluid was lost from the well to the formations.⁹¹ Halliburton’s April 18, 2010, report also showed that, according to its modeling, the ECD during cement displacement would exceed the fracture pressure at 18,189 ft. by more than 400 psi.⁹² See Figure 22.

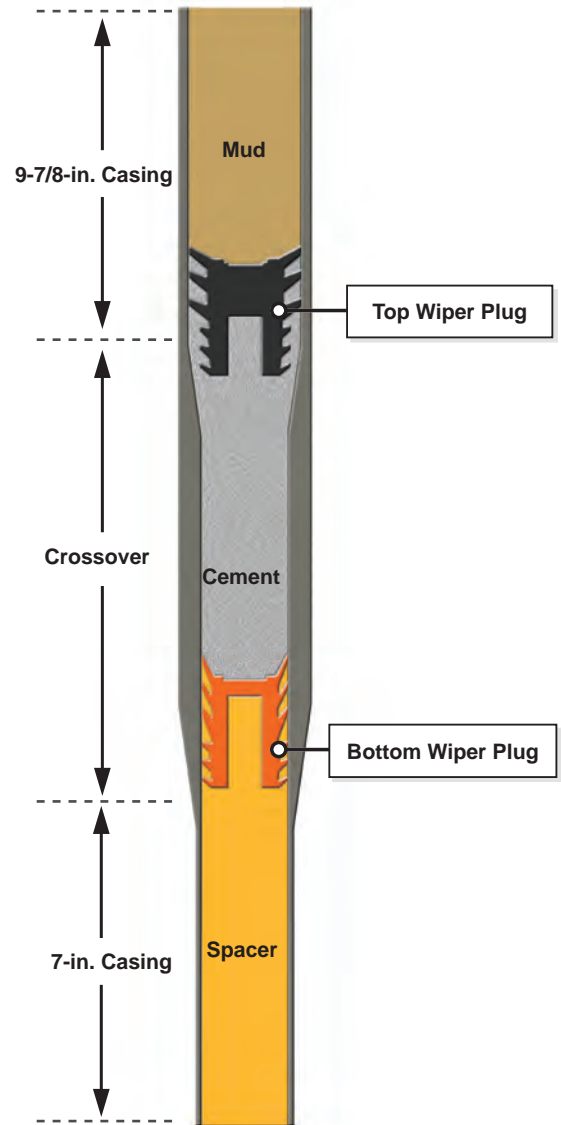

Figure 21 Example of Top and Bottom Cement Wiper Plugs

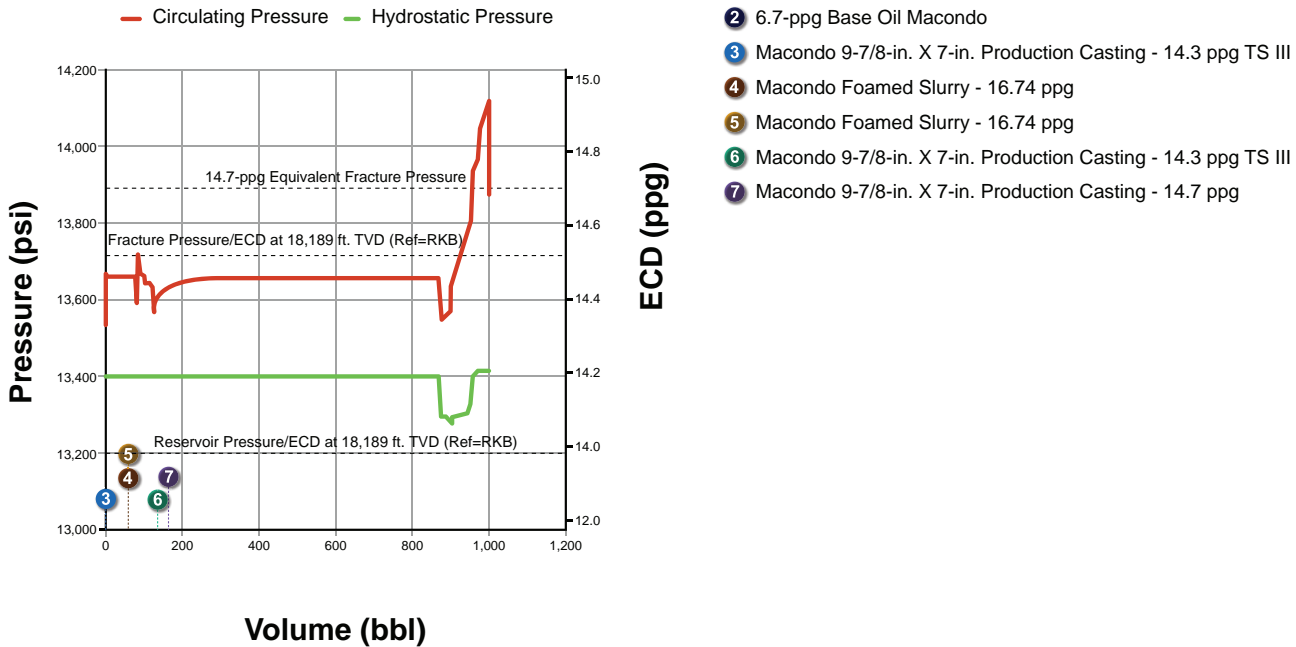

Figure 22 Circulating Pressure and Density Plot Showing Fracture Pressure would be Exceeded During Displacement (*Circulating Pressure and Density at Reservoir Zone: Downhole Annular Pressure and ECD vs. Liquid Volume*)

When nearing the end of the displacement, the displacement rate was maintained at 4.2 bpm until the top plug bumped.⁹³ It is unclear why BP did not reduce the rate of displacement to ensure a minimal ECD, as a key reason for selecting foamed cement was to limit ECD during the cement placement.

Data recorded during the displacement of the cement shows a distinct change in the flow-out volume subsequent to bumping the bottom plug. The return flow rate decreased by approximately 0.4 bpm then remained constant until the end of displacement.⁹⁴ Normally, a small increase in flow rate may be expected as the foamed cement rises in the annulus and expands proportionally to the increase in its foam quality.

The decrease indicates that losses may have occurred when the fracture pressure was exceeded. This flow-rate reduction would equal a 4.9-bbl loss over 12.5 minutes. The investigation team was unable to identify the specific loss zone and loss fluid. A 4.9-bbl loss of cement, approximately 10% of the planned total volume, would reduce the estimated top of cement by 96 ft. to only 412 ft. above the shallowest hydrocarbon-bearing sand, possibly compromising the effectiveness of the barrier. See *Figures 23 and 24*.

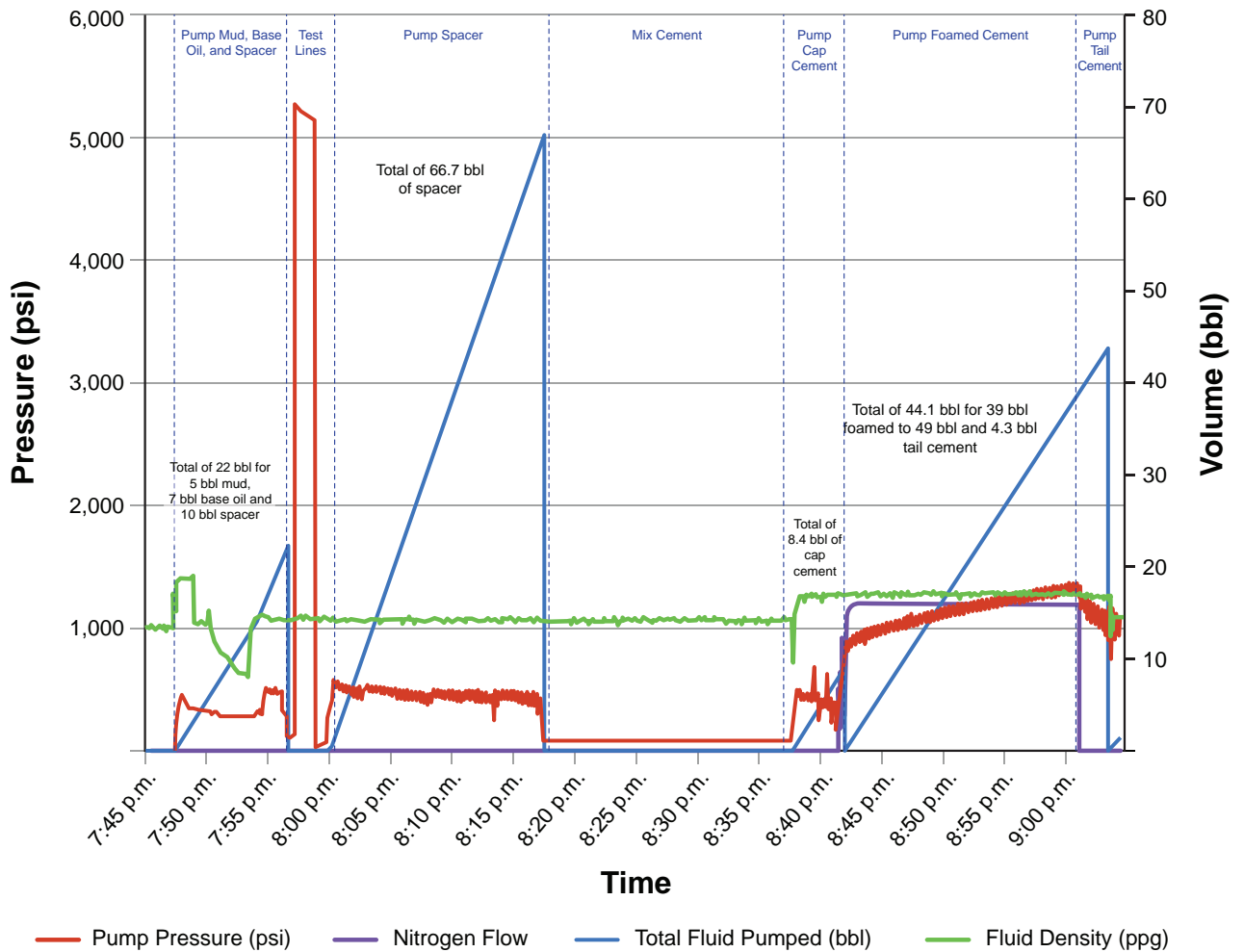

Figure 23 Actual Cement Volumes Pumped for 9-7/8-in. x 7 in. Production Casing (April 19, 2010)

Cement Contamination

The investigation team believes that contamination could have contributed to the failure of the cement. While the contamination of cement is not an uncommon occurrence, excessive contamination can prevent the cement from hardening, thus extending its setting times and distorting properties from the values determined from laboratory testing.

Because Halliburton ran only limited tests on spacer/mud/cement compatibility, the investigation team believes that the cement in the annulus and shoe track could have been contaminated with mud and/or spacer, potentially delaying or preventing the cement from setting and developing the required compressive strength.^{AA}

AA The ratios of the various fluids tested should have been run in 5% increments (e.g., 95/5% to 5/95%).

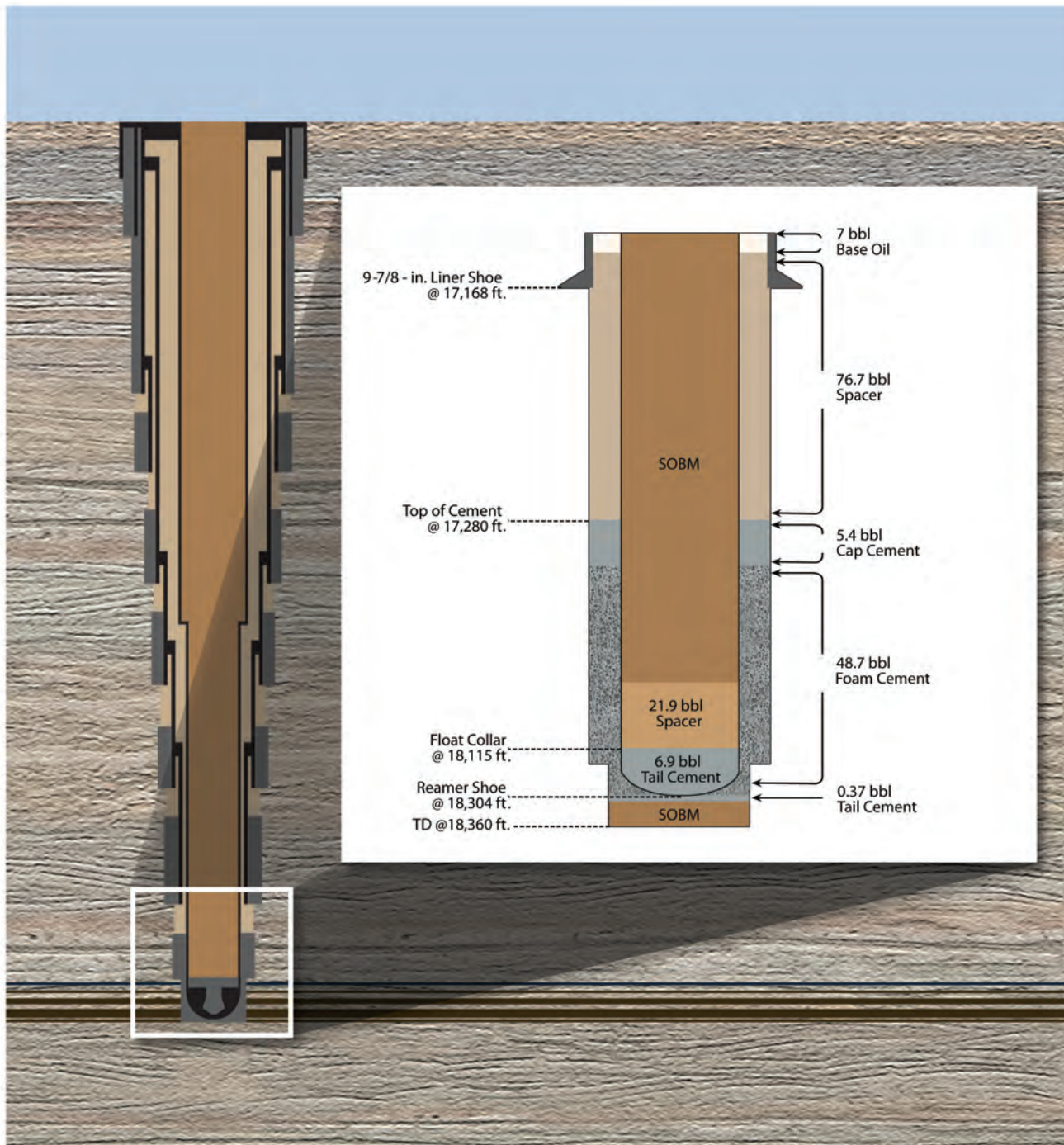

Figure 24 Actual Cement Volumes Pumped for 9-7/8-in. x 7-in. Production Casing (April 19, 2010)

Contributing to the likelihood of contamination was the length of casing through which the cement had to be pumped. At 13,055 ft., the wiper plugs had to remove contaminant along a considerable length of casing, compared to the small volume of cement the operator had planned to pump.^{95, AB} The BP well team was aware of the risks associated with pumping such a small volume over the long interval and was concerned about contamination.⁹⁶ Running and cementing a liner instead of the long string may have decreased this risk by reducing the amount of contaminants wiped from the casing wall during displacement.^{AC}

AB The bottom plug is released ahead of the cement and the top plug immediately after cement is pumped into the well and travels the length of the casing string. The plugs mark the beginning and end of the cement volume and help minimize contamination of the cement by the drilling mud.

AC Running a liner differs from running a long string, as a liner is hung some feet inside the previous casing shoe instead of being extended back up to the wellhead, making it significantly shorter in length.

It is possible that cement mixed with the lighter drilling mud left in the rat hole, which could have caused contamination. Before pulling the drill string out of the hole to run casing, a heavy mud “pill” typically is left in the rat hole to minimize contamination as a result of the mixing of the two fluids of differing densities.^{AD} The BP well team, however, chose not to use a heavy mud pill in the rat hole due to concerns that the weight could cause fluid loss to at least one of the formations.^{97, AE}

The investigation team analyzed the cement volume to determine whether there was any evidence that contamination occurred during displacement. Volumes were calculated at two locations (See Figure 25):

- Where the plugs went through the 9-7/8-in. x 7-in. crossover at 12,487 ft.
- Where the plugs reached the float collar at 18,115 ft.

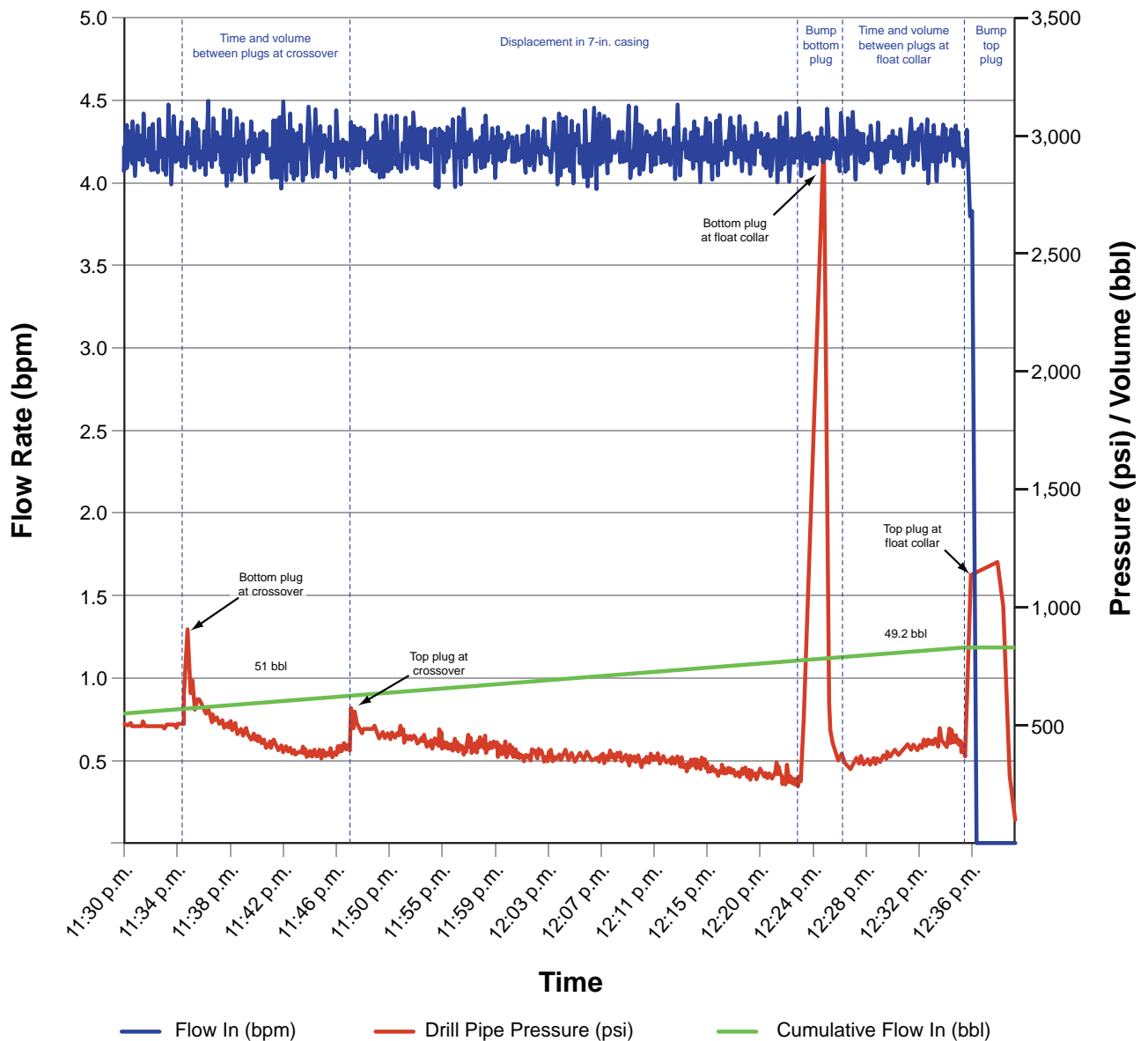

Figure 25 Reduction in Foamed Slurry Volume from 12,487 ft. crossover to 18,115 ft. (Float Collar)

AD The rat hole is an extra hole drilled beyond the planned casing shoe depth to allow for junk, hole fill-in, and other conditions that may reduce the effective depth of the well prior to or while running casing.

AE Higher density mud would increase the hydrostatic pressure on the open-hole formation and increase the risk of fracturing.

It is estimated that a reduction of about 1.6 bbl of slurry volume should have occurred between locations 1 and 2.^{AF} However, the volume observed decreased by only 0.8 bbl while displacing cement between the two reference points.⁹⁸ This would indicate that 0.8 bbl of contaminant moved between the plugs and/or nitrogen gas had separated from an unstable foamed slurry and leaked above the top plug.

Testing performed by CSI Technologies on behalf of BP concluded that the foamed slurry was not stable and that nitrogen likely escaped, masking the true cement slurry volume.⁹⁹ Testing performed by Chevron for the President's National Oil Spill Commission also drew the same conclusion.¹⁰⁰ It is unknown exactly how much of a reduction in foamed slurry could result from instability *versus* the 1.6-bbl reduced volume due to the compressibility of the nitrogen gas. This could have potentially masked further amounts of contamination.

Testing performed by Chevron showed that the final sonic compressive strength of the base slurry cement decreased as mud contamination increased. The time to reach 100 psi was not greatly affected by levels of contamination of up to 30%.¹⁰¹ However, test results identified that even with a 5% contamination of cement with drilling mud, the final sonic compressive strength of the cement was reduced by more than 1,000 psi. A 30% contamination reduced the final strength of the cement from 4,210 psi to only 828 psi.^{AG}

Cement Program Execution Conclusions

It is estimated that 4.9 bbl of fluid loss occurred during the final displacement of the cement. If the lost fluid was cement, this could have reduced the top of cement by approximately 96 ft., placing the cement at 17,376 ft., or 412 ft. above the top of the hydrocarbon-bearing sand.¹⁰² This is a significant loss of cement volume compared to the total cement quantity. Documentation shows that no reduction in pump rate toward the end of the displacement was specified to reduce the chance of formation fracture and losses.

Contamination may have occurred from mud/spacer (contaminant) wiped from the interior wall of the casing into the cement as it traveled the length of pipe down to the float collar, and the mixing of cement with the lower density 14.17-ppg mud left in the rat hole.

Review of the volume reduction of foamed cement showed a possibility of mud contamination and/or loss of nitrogen from the foam cement slurry.¹⁰³ Unstable foam slurries will have a less-than-expected volume reduction and, therefore, mask the presence of contaminants. Any contaminant likely would have had a negative effect on the slurry by increasing setting time and reducing overall maximum compressive strength.

3.1.7 Post-Cement Job Review

Once cementing operations were completed on the production casing, a detailed post-job review could have identified areas of concern. For example, if performed soon after cementing, effective zonal isolation can be determined by cementing evaluation logs and assessments of pressure and temperature. However, BP did not run critical cement bond logs (CBLs), which could have helped determine the height and quality of the cement.^{104, AH} Moreover, misinterpretation of differential pressure at the end of the cement job meant that, in addition to the difficulties in converting the float collar, there was no way to confirm that it actually converted.

AF Foamed cement slurries will reduce in volume as they are pumped downhole from the surface due to the compressible nature of the nitrogen gas contained within the slurry. The foamed cement is compressed due to increasing pressure from the fluid above it as displacement progresses. This is based on estimated pressure and temperature at the crossover and float assembly of 9,200 psi/120°F and 13,350 psi/135°F, respectively.

AG However, this indication does not enable a conclusion to be reached that the cement can withstand certain loads and pressures to which it will be exposed. That conclusion can only be reached upon learning the final compressive strength of the cement, which in this case was substantially reduced by the contamination.

AH A cement bond log (CBL) is a tool used to assess the quality of a cement job by evaluating the bonding between the cement and the casing. Alternatively, a temperature log may have been run to identify the top of cement after setting.

Lift Pressure

Once cement has been fully displaced, it should occupy the internal space within the casing shoe track and extend up to a pre-determined height in the annulus, as specified in the operator's well plan. Normally, a U-tube effect occurs because the longer cement column in the annulus exerts more pressure than the shorter cement column inside the casing. That difference in pressure, or lift pressure, must be determined accurately to confirm that the float collar is functioning properly. As noted previously, the float collar valves should block the back-pressure from the cement in the annulus, stopping the cement from flowing back into the casing. Lift pressure is the only way to test the effectiveness of the float collar once cementing operations are completed. See Figure 26.

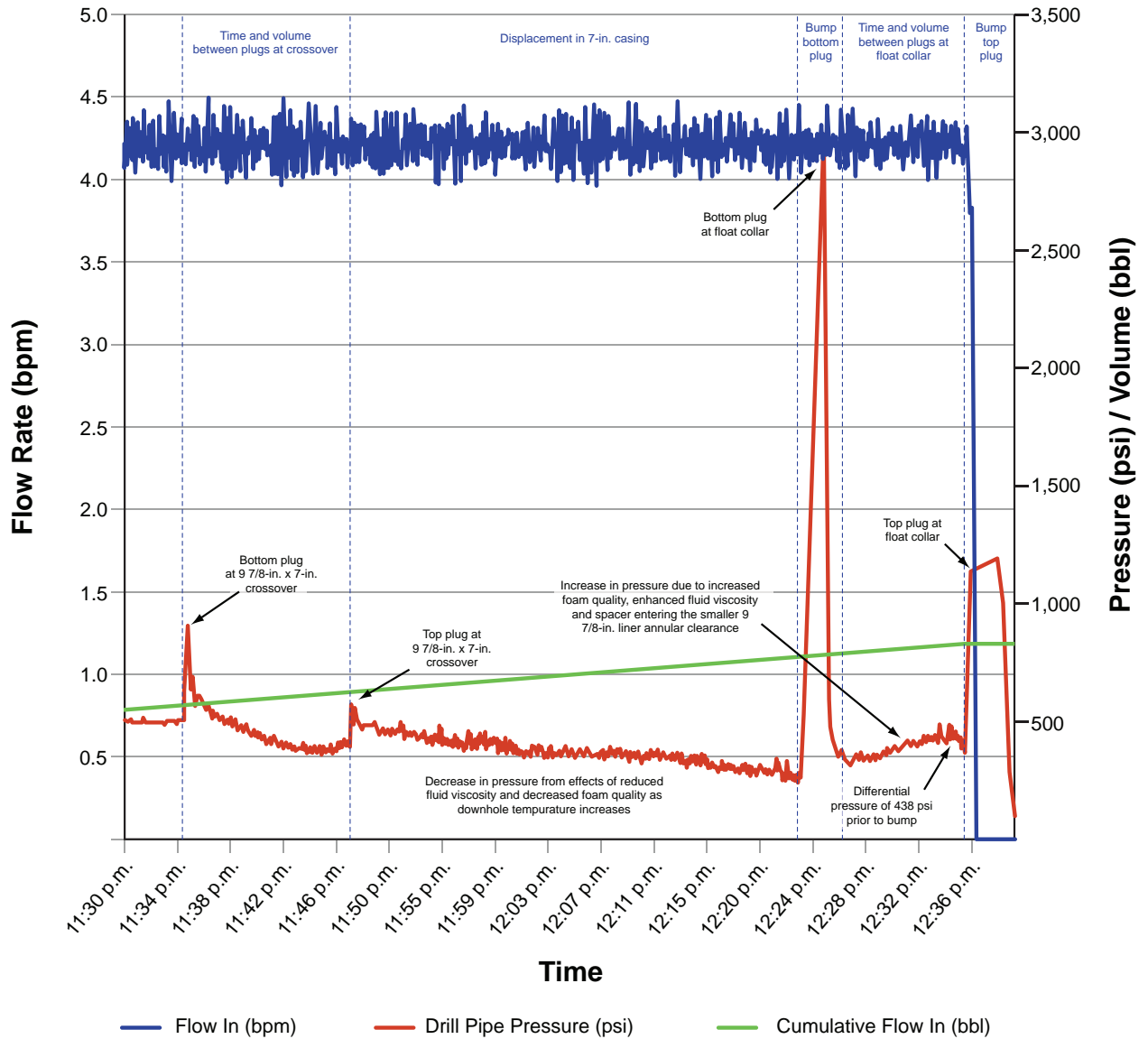

Figure 26 Differential Pressure at the End of 9-7/8-in. x 7-in. Production Casing Cement Program Displacement (April 19, 2010)

Lift Pressure Misinterpreted

Halliburton's post-job analysis reported that the lift pressure was 100 psi as displacement neared completion.¹⁰⁵ Correspondence between the BP well site and onshore teams put the lift pressure at 80 psi.¹⁰⁶

The investigation team's analysis indicates that BP and Halliburton mistakenly attributed frictional pressure resulting from the movement of viscous spacer in the annulus between the 9-7/8-in. liner and 7-in. production casing annulus to the pressure exerted by the cement column. The actual pressure exerted by the annular cement column was lower, resulting in a lower lift pressure.^{A1} Instead, the measurements represented the frictional pressure increase that results when the viscous spacer moves into the more restricted 9-7/8-in. liner and 7-in. production casing annulus. As previously discussed, in contrast to normal practice, the displacement rate was not reduced near the end of the displacement (which would have reduced the friction) but was kept constant for the duration.

Halliburton's post-job report notes that at 12:43 a.m. the "floats held" and were not leaking. As discussed, the only way to check that the floats are holding is to check for backflow of fluids due to the U-tube effect from the lift pressure, which did not exist here.

Table 1 illustrates the theoretical state of the well immediately after the 5 bbl were bled off at the surface to check that the float valves were not leaking. This table is theoretical, as it is difficult to calculate the exact pressure exerted by foamed slurry due to the effects of pressure changes within the wellbore. The table shows that, contrary to a normal cement job, the internal casing pressure exceeded that of the annulus. This meant that there was no means to test the effectiveness of the auto-fill float valve.

Lift Pressure Summary – After 5 bbl Surface Bleed Off to Check Float Valves					
Annulus					
Fluid	Volume (bbl)	Density (ppg)	Fluid Top (ft.)	Length (ft.)	Pressure (psi)
SBM to Flowline (6.37 ft)		14.17	6.37	14,445	10,644
Base oil	7	6.70	14,451	110	38
Spacer	76.7	14.30	14,561	2,716	2,020
Base Slurry	5.4	16.74	17,277	106	92
Foamed Cement	48.7	14.50	17,383	909	686
Base Slurry	0.37	16.74	18,292	12	10
Totals				18,298	13,489
Casing					
Fluid	Volume (bbl)	Density (ppg)	Fluid Top (ft.)	Length (ft.)	Pressure (psi)
SBM to Bleed Valve (-34.91 ft.)		14.17	-34.91	17,553	12,933
Spacer	21.9	14.30	17,518	597	444
Base Slurry	6.93	16.74	18,115	189	165
Totals				18,339	13,542
Lift Pressure (psi)					-53

Table 1 Theoretical Lift Pressure at End of Displacement while Checking Float Equipment

Having a higher pressure inside the casing means that fluid would flow in the opposite direction — into the annulus. There is no evidence that the BP well team completed post-job calculations to verify the final hydrostatic pressures. Such calculations could have helped the well team to realize that no verification existed on the float valves and could have led them to take additional precautions prior to the negative pressure test.

A1 The difference in pressure seen prior to bumping the top wiper plug on the float collar at approximately 4 bpm was 438 psi. The initial circulating pressure at about 4.2 bpm with drilling mud was 330 psi. Lift pressure = 438 psi – 330 psi = 108 psi.

The discussion above on the lift pressure also can be correlated back to the cement program. At BP's direction, Halliburton incorporated base oil into the fluid schedule to minimize pressure on the formation.¹⁰⁷ Pumping base oil, which is much lighter than drilling mud, ahead of the spacer reduced the lift pressure by approximately 42 psi at the end of the job. This further ensured that there was no back-pressure to confirm whether the float collar was, in fact, holding.

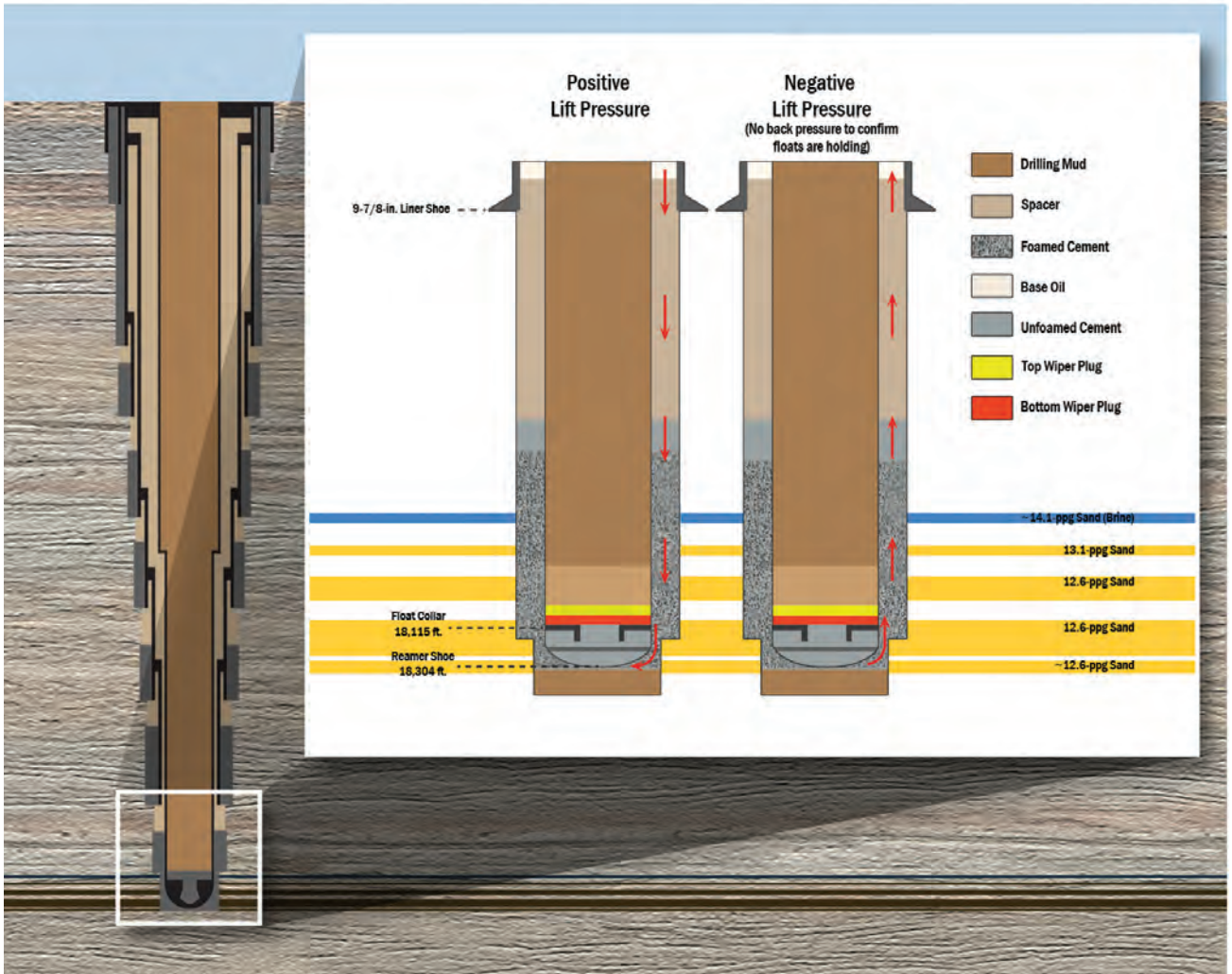

Figure 27 Expected (Positive) and Actual (Negative) Lift Pressure Post Cementing of the Production Casing

Figure 27 illustrates the expected direction of flow due to the U-tube effect (positive lift pressure) and the actual direction of fluid flow once displacement was completed (negative lift pressure) on the Macondo well.

3.1.8 Well Design and Production Casing Cement Findings of Fact

- BP chose a long-string production casing design that would likely generate higher equivalent circulating density (ECD) than the installation of a liner. Concerned with losing fluids into the formations, BP compensated for the higher ECD of the long-string design by having Halliburton devise a cement program that minimized pressure wherever possible. The resulting program was minimal in volume, technically complex, difficult to execute, and left little to no margin for error. This decision increased risk, yet BP proceeded without conducting adequate safety reviews. Transocean had no role in developing the casing and cement design and was not made aware of the risks created by the way in which the cement program was executed.
- The foamed cement design was abnormally complex: It called for a small volume pumped over a long interval of time with tight ECD restrictions. It also presented challenges of obtaining correct base slurry density, controlling the accurate delivery of nitrogen, maintaining foam stability, and achieving target density after foaming. This required the cement program to be executed precisely as planned to achieve the required results.
- The bottom hole static temperature (BHST) utilized for cement testing was incorrect, causing doubts as to the accuracy of the bottom hole circulating temperature (BHCT). Based on the documented BHST of 242°F, the cement in the well may have been in the temperature range of approximately 160–190°F, 17 hours after the cement was in place (at the time of the negative pressure test), which is the range at which retarded cements demonstrate longer thickening times. Ultimately, the lab test results did not give a clear indication of when the cement would set.
- The cement testing program was inadequate, as critical tests were not performed. Several tests performed by Halliburton before the cement operation indicated that the foamed slurry would be unstable; Transocean was not privy to testing or lack of testing on the cement. These tests were confirmed again in post-incident testing performed by Chevron. Neither BP nor Halliburton knew how the slurry would perform and had no true indication of when the cement would be set but still proceeded with the cementing operation.
- Nine attempts were made to convert the float collar, and it is possible that it never converted. Once the surface pressure had increased to more than 1,300 psi, the actuating ball could have passed through the flow tube ball seat without converting the collar. After cementing operations were completed, there was no lift pressure (the fluids in the casing exerted more pressure than the fluids in the annulus), and thus there would have been no flow from the annulus into the casing to verify conversion of the float collar valves to keep the cement in place as designed. BP misinterpreted the pressure at the end of the cement job to be lift pressure, further complicating the ability to confirm whether the float collar was, in fact, holding. While BP had concerns that the conversion may not have been successful, those concerns were never communicated to Transocean.
- BP did not conduct a full bottoms-up circulation, which would have increased the probability of a successful cement job. Instead, the operator fell short of its own plan to circulate an operational minimum standard of 1,315 bbl, pumping only 346 bbl (less than 30% of BP's minimum).
- Mud or spacer may have contaminated the cement slurry when it was wiped from the inner walls of the casing. Lower-density mud left in the rat hole may have mixed with the cement slurry, further leading to contamination. Calculation of the cement volume change between the casing crossover and the float collar showed there was some contamination.
- Fluid losses to the formation likely resulted when fracture pressure was exceeded near the end of the cement displacement. If that fluid was cement, the top of the cement could have been reduced by approximately 96 ft., and the amount of cement lost would be significant compared to the total volume of cement used.

BP and Halliburton failed to isolate the reservoir due to the poorly planned, executed, and untested cement program. These flaws in the planning, execution, and verification of the cement program are the precipitating cause of the incident.

1. Daily Drilling Report, Oct. 6, 2009, TRN-USCG_MMS-00011649; Daily Drilling Report, Oct. 7, 2009, TRN-USCG_MMS-000111409, 17.
2. Daily Drilling Report, February 28, 2010, TRN-HCJ-00090850; Daily Drilling Report, April 19, 2010, TRN-MDL-00011512; Daily Drilling Report, April 20, 2010, TRN-MDL-00011518.
3. Daily Drilling Report, March 1, 2010, TRN-USCG_MMS-00026159; Daily Drilling Report, April 20, 2010, TRN-MDL-00011518.
4. Sperry Sun Drilling Services data logs (cement unit data), April 18-20, 2010; Daily Drilling Report, April 20, 2010, TRN-MDL-00011518.
5. *Ibid.*
6. Sperry Drilling Services data logs (cement unit data), April 18–20, 2010.
7. Development Driller II Daily Operations Report, Oct. 11–13, 2010.
8. National Commission on the BP *Deepwater Horizon* Oil Spill and Offshore Drilling, Nov. 8, 2010.
9. Macondo Prospect APB Mitigation, May 19, 2009, BP-HZN-MBI00098759; Richard Miller e-mail to Brian Morel, April 14, 2010, BP-HZN-CEC021857.
10. Morning Report, April 18, 2010, TRN-MDL-00287350; Morning Report, April 19, 2010, TRN-MDL-00287353; Daily Drilling Report, April 18, 2010, TRN-MDL-00011508.
11. TD Forward Plan Review Production Casting Options, April 13, 2010, BP-HZN-CEC-022145, 53.
12. Stress Engineering Services, Inc., Macondo Casing Calculations, Feb. 24, 2011.
13. 30CFR250.1714–21.
14. Morning Report, April 18, 2010, TRN-MDL-00287350; Morning Report, April 19, 2010, TRN-MDL-00287353; Daily Drilling Report, April 18, 2010, TRN-MDL-00011508; Daily Drilling Report, April 20, 2010, TRN-MDL-00011518.
15. 9-7/8" x 7" Production Casing Design Report, April 18, 2010, HAL_0010988.
16. John Guide e-mail to Greg Walz, "Additional Centralizers," April 16, 2010, BP-HZN-CC022433.
17. Brian Morel e-mail to Jesse Gagliano, et. al., April 15, 2010, HAL_0010648.
18. GoM Exploration Well 7" x 9-7/8" Interval, April 15, 2010, BP-HZN-CEC021281.
19. 7" M45AP Float Collar Mid Bore, WiperLok Pleate Drawing, Jan. 16, 2010, D000401284 A.1, BP-HZN-BLY-00046014; Reamer Shoe, DBK 7" CSG x 8-1/4" Drawing, Feb., 7, 2008, D000316516.A.5.
20. Daily Drilling Report, April 19, 2010, TRN-MDL-00011512; Morning Report, April 19, 2010, TRN-MDL-00287353; Sperry Drilling Services data logs (drilling parameters), April 5, 2010–April 20, 2010; Sperry Drilling Services data logs (drilling parameters with cement unit data), April 15–20, 2010.
21. *Ibid.*
22. Daily Drilling Report, April 19, 2010, TRN-MDL-00011512; Morning Report, April 19, 2010, TRN-MDL-00287353.
23. GoM Exploration Well 7" x 9-7/8" Interval, April 15, 2010, BP-HZN-CEC021281.
24. 7" M45AP Float Collar Mid Bore, WiperLok Pleate Drawing, Jan. 16, 2010, D000401284 A.1, BP-HZN-BLY-00046014.
25. Daily Drilling Report, April 19, 2010, TRN-MDL-00011512; Morning Report, April 19, 2010, TRN-MDL-00287353; Sperry Drilling Services data logs (drilling parameters), April 5-20, 2010; Sperry Drilling Services data logs (drilling parameters with cement unit data), April 15-20, 2010.
26. BP Investigation Team Interview of Robert Kaluza, April 28, 2010, BP-HZN-MBI00021237, 44.
27. BP Investigation Interview of Robert Kaluza, April 28, 2010, BP-HZN-CEC-020172.
28. Brian Morel e-mail to Don Vidrine, et. al., April 20, 2010, BP-HZN-MBI-00021237, 44, 182, 172; Daily Drilling Report, April 19, 2010, TRN-MDL-00011512.
29. Daily Drilling Report, April 19, 2010, TRN-MDL-00011512; Sperry Drilling Services data logs (drilling parameters with cement unit

- data), April 15-20, 2010; Bob Kaluza Interview BP-HZN-MBI-00021271.
30. E-mail from Maxie Doyle to Brett Cocalis, et al., April 20, 2010, BP-HZN-MBI 00129100.
 31. BP Investigation Team Interview of Robert Kaluza, April 28, 2010, BP-HZN-MBI00021237, 71; Sperry Drilling Services data logs (drilling parameters), April 5–20, 2010; Sperry Drilling Services data logs (drilling parameters with cement unit data), April 15–20, 2010.
 32. BP Investigation Interview of Robert Kaluza, April 28, 2010, BP-HZN-MBI00021237, 44, 55, 71, 75.
 33. BP Investigation Interview of Brian Morel, April 27, 2010, BP-HZN-CEC-020232, 35; See Appendix C.
 34. See Appendix C.
 35. Sperry Drilling Services data logs (drilling parameters), April 5-20, 2010; Sperry Drilling Services data logs (drilling parameters with cement unit data), April 15-20, 2010.
 36. MC 252 # 1 - Macondo Prospect 9-7/8 Casing Interval, BP-HZN-CEC 8848.
 37. Sperry Drilling Services data logs (drilling parameters), April 5–20, 2010; Sperry Drilling Services data logs (drilling parameters with cement unit data), April 15–20, 2010; Testimony of John Guide, Hearing before the *Deepwater Horizon* Joint Investigation Team, July 22, 2010 a.m., 87:2–13.
 38. Daily Drilling Report, April 15, 2010, TRN-MDL-00011495; Daily Drilling Report, April 16, 2010, TRN-MDL-00011499; Dailey Drilling Report, April 17, 2010, TRN-MDL-00011503.
 39. See Appendix E.
 40. BP, Deepwater Horizon Accident Investigation Report, Appendix J: Halliburton Lab Results- # 73909/2.
 41. See Appendix E.
 42. Cement Lab Weigh-up Sheet, April 13, 2010: US-73909/1, HAL_DOJ_0000035; Cement Lab Weigh-up Sheet, April 17, 2010: US-73909/1, HAL_DOJ_0000042.
 43. See Appendix E; SPE23707, Retardation of Cement Slurries to 250°F, Benstead, J. – BP Int'l Ltd.
 44. BP, Deepwater Horizon Accident Investigation Report, Appendix J: Halliburton Lab Results- # 73909/2.
 45. *Ibid.*
 46. BP, Deepwater Horizon Accident Investigation Report, Appendix J: Halliburton Lab Results- # 73909/2; see also Appendix E.
 47. BP, Deepwater Horizon Accident Investigation Report, Appendix J: Halliburton Lab Results- # 73909/2.
 48. Well Cementing (Second Edition), Erik B. Nelson and Dominique Guillot, eds. (2006), 443.
 49. See Appendix E.
 50. *Ibid.*
 51. 9-7/8" x 7" Production Casing Design Report, April 18, 2010, HAL_0010988,1005,1009.
 52. BP, Deepwater Horizon Accident Investigation Report, Appendix J: Halliburton Lab Results- # 73909/2.
 53. Chevron Cement Test Results for National Oil Spill Commission, 04.
 54. See Appendix E.
 55. BP, Deepwater Horizon Accident Investigation Report, Appendix J: Halliburton Lab Results- # 73909/2.
 56. See Appendix E.
 57. BP, Deepwater Horizon Accident Investigation Report, Appendix J: Halliburton Lab Results- # 73909/2.
 58. Sperry Drilling Services data logs (drilling parameters with cement unit data), April 15–20, 2010.
 59. Daily Drilling Report, April 19, 2010, TRN-MDL-00011512; Morning Report, April 19, 2010, TRN-MDL-00287353.

60. BP, *Deepwater Horizon* Accident Investigation Report, Sept. 8, 2010, 57.
61. BP, *Deepwater Horizon* Accident Investigation Report, Appendix J: Halliburton Lab Results- # 73909/2.
62. Chevron Cement Testing Results for National Oil Spill Commission, Section 6, 07.
63. Tommy Roth and John Gisclair, BP *Deepwater Horizon* Investigation Preliminary Highlights, September 26, 2010, 6.
64. Chevron Cement Testing Results for National Oil Spill Commission Section 4, 05.
65. See Appendix E.
66. 9-7/8" x 7" Production Casing Design Report, April 18, 2010, HAL_0010988, 1005.
67. Chevron Cement Testing Results for National Oil Spill Commission, Section, 05.
68. Chevron Cement Testing Results for National Oil Spill Commission Section, 12, 13–14.
69. Rheology of Foamed Cement, R.M. Ahmend, et al; *Cement and Concrete Research* 39 (2009) 353–361.
70. 9-7/8" x 7" Production Casing Design Report, April 18, 2010, HAL_0010988, 97; see also Appendix E.
71. BP, *Deepwater Horizon* Accident Investigation Report, Appendix J: Halliburton Lab Results- # 73909/2.
72. 9-7/8" x 7" Production Casing Design Report, April 18, 2010, HAL_0010988, 1005.
73. BP, *Deepwater Horizon* Accident Investigation Report, Appendix J: Halliburton Lab Results- # 73909/2.
74. Chevron Cement Testing Results for National Oil Spill Commission SectionChapter 8, 08.
75. See Appendix E; CSI Technologies, *Laboratory Analysis of Cementing Operations on the Deepwater Horizon*, Aug. 11, 2010; Chevron Cement Testing Results for National Oil Spill Commission.
76. BP, *Deepwater Horizon* Accident Investigation Report, Appendix J: Halliburton Lab Results- # 73909/2.
77. BP, *Deepwater Horizon* Accident Investigation Report, Appendix J: Halliburton Lab Results- # 73909/2.
78. CSI Technologies, *Laboratory Analysis of Cementing Operations on the Deepwater Horizon*, August 11, 2010, 3.
79. Chevron Cement Testing Results for National Oil Spill Commission.
80. *Well Cementing (Second Edition)*, Erik B. Nelson and Dominique Guillot, eds. (2006), 644–46, 658.
81. See Appendix E.
82. Chevron Cement Testing Results for National Oil Spill Commission, 12–13.
83. *Ibid.*
84. CSI Technologies, *Laboratory Analysis of Cementing Operations on the Deepwater Horizon*, Aug. 11, 2010.
85. Chevron Cement Testing Results for National Oil Spill Commission, 9–12.
86. BP, *Deepwater Horizon* Accident Investigation Report, Appendix J: Halliburton Lab Results- # 73909/2.
87. BP, *Deepwater Horizon* Accident Investigation Report, Appendix J: Halliburton Lab Results- # 73909/2.
88. Daily Drilling Report, April 19, 2010; TRN-MDL-00011512.
89. Sperry Drilling Services data logs (cement unit data), April 18–20, 2010.
90. Sperry Drilling Services data logs (drilling parameters), April 5–20, 2010; Sperry Drilling Services data logs (drilling parameters with cement unit data), April 15–20, 2010; Daily Drilling Report, April 20, 2010, TRN-MDL-00011518.
91. Daily Drilling Report, April 14, 2010, TRN-MDL-00026249; Robert Bodedk e-mail to Michael Beirne, April 13, 2010, BP-HZN-MBI00126338; Daily Drilling Report, April 4, 2010, TRN-MDL-00026249.
92. 9-7/8" x 7" Production Casing Design Report, April 18, 2010, HAL_0010988, 1012.

93. Sperry Drilling Services data logs (drilling parameters with cement unit data), April 15–20, 2010; Sperry Drilling Services data logs (cement unit data), April 18–20, 2010; Sperry Drilling Services data logs (drilling parameters with cement unit data), April 15–20, 2010.
94. Sperry Drilling Services data logs (drilling parameters), April 5–20, 2010; Sperry Drilling Services data logs (cement unit data), April 18–20, 2010; Sperry Drilling Services data logs (drilling parameters with cement unit data), April 15–20, 2010.
95. Daily Drilling Report, April 19, 2010, TRN-MDL-00011512; Morning Report, April 19, 2010, TRN-MDL-00287353; Daily Drilling Report, April 20, 2010, TRN-MDL-00011518.
96. Testimony of Greg Walz at the Hearing before the *Deepwater Horizon* Joint Investigation Team, Oct. 7, 2010.
97. Testimony of John Guide, Hearing before the *Deepwater Horizon* Joint Investigation Team, Oct. 7, 2010, 94:22–25, 96:1–3.
98. Sperry Drilling Services data logs (drilling parameters), April 5–20, 2010; Sperry Drilling Services data logs (cement unit data), April 18, 2010–April 20, 2010; Sperry Drilling Services data logs (drilling parameters with cement unit data), April 15–20, 2010.
99. CSI Technologies, Laboratory Analysis of Cementing Operations on the *Deepwater Horizon*, Aug. 11, 2010.
100. Chevron Cement Testing Results for National Oil Spill Commission, Chapter 9, 9–12.
101. Chevron Cement Testing Results for National Oil Spill Commission, Chapter 10, 12.
102. See Appendix E.
103. Chevron Cement Testing Results for National Oil Spill Commission, Chapter 9, 9–12; BP, *Deepwater Horizon* Accident Investigation Report; Appendix G
104. Testimony of John Guide, Hearing before the *Deepwater Horizon* Joint Investigation Team, Oct. 7, 2010, 96:3–8; Brian Morel e-mail to Ronald Sepulvado, April 14, 2010, BP-HZN-MBI-00126982; Macondo Production casing and TA Forward Planning Decision Tree; April 14, 2010, BP-HZN-MBI00010575.
105. 9.875" x 7" Foamed Production Casing Post Job Report, April 20, 2010, HAL_11195.
106. Brian Morel e-mail message to John Guide, et. al., April 20, 2010, BP-HZN-MBI00129053.
107. Testimony of Greg Walz at the Hearing before the *Deepwater Horizon* Joint Investigation Team, Oct. 7, 2010. PM, page 91.

3.2 Temporary Abandonment

3.2 Temporary Abandonment

After the cementing operation, the operator proceeded with its plan to temporarily abandon the Macondo well.¹ Temporary abandonment is the process by which a well is secured so that the operator can safely leave the well before returning to begin completion operations. The temporary abandonment plan at Macondo involved Transocean removing the *Deepwater Horizon* blowout preventer (BOP) stack and riser once the well was secured, followed by the departure of the drilling rig.

BP was responsible for developing the temporary abandonment plan and directing the execution of procedures by the drill crew.² As employees of the drilling contractor, the drill crew was reliant upon BP and its engineers both on the rig and onshore to develop proper procedures. Federal regulations require the operator to submit its temporary abandonment plan in writing to the Minerals Management Service (MMS) for approval at least 48 hours before temporary abandonment begins.³ Regulations also require that, as part of the temporary abandonment plan, the operator set a cement plug at least 100 ft. in length in the casing at a depth of no more than 1,000 ft. below the mud line (or sea floor). Given the importance of these procedures, the MMS also requires operators to submit information including, but not limited to, the following:

- Well schematics that include well depth, plug types, plug locations, and plug lengths
- Properties of the mud and cement to be used
- Plug testing plans
- Recent well test data and pressure data
- The process the operator used for determining the maximum possible surface pressure
- The type and weight of well fluid to be used
- The proposed temporary abandonment procedure

The following section outlines the development of the temporary abandonment plan and alterations made to the plan, which changed the risk profile of the operation during the last few days prior to the incident.

3.2.1 BP's Temporary Abandonment Plans

BP engineers generated at least five temporary abandonment plans between April 12, 2010 and April 20, 2010.⁴ The plans varied considerably, as did the level of risk they introduced. BP's changes included, but were not limited to, displacing the well before conducting a negative pressure test and underbalancing the well (i.e., allowing pressure in the formations to exceed pressure in the well) before placing a secondary cement barrier. Of the five temporary abandonment plans generated, the operator submitted and MMS approved only one, dated April 16, 2010. *Figure 1* illustrates the evolution of these plans.

The final procedure implemented by the operator was not approved by the MMS, nor was it developed and delivered to the *Deepwater Horizon* until the morning of April 20, 2010, after BP had already started the temporary abandonment operation. Further, the investigation team found no evidence that BP personnel on the rig and onshore subjected any of the temporary abandonment plans to a formal risk assessment process.

The following outlines the investigation team's finding that BP's final temporary abandonment plan contributed to the cause of the incident. In summary:

- Confusion existed among BP personnel as to the proper design of the temporary abandonment plan.
- The operator did not inform its own well site leader or the drill crew of the final temporary abandonment plan until after the work had commenced; there is no evidence that the associated risks were communicated to the drill crew.
- Risk resulting from the questionable cement operations and float collar conversion was not adequately accounted for by the operator.
- The decision to displace and set a surface cement plug in seawater rather than heavy drilling mud exposed the well to an underbalanced state prior to the installation of a secondary cement barrier.

- The underbalance was magnified significantly by the decision to place the plug 3,300 ft. below the mud line.
- The final procedure was never approved by MMS.
- The final “procedure” was merely a bullet-point outline with minimal detail, as denoted by its title: “Quick Ops Note.” See Figure 7.
- The team found no evidence that formal risk assessments were conducted on the viability, safety, and alternative approaches to the various plans.

What follows is an outline of each of the plans generated by the operator and the evolution of procedural changes that ultimately resulted in a final temporary abandonment plan that contained unnecessary risk and contributed to the cause of the incident.

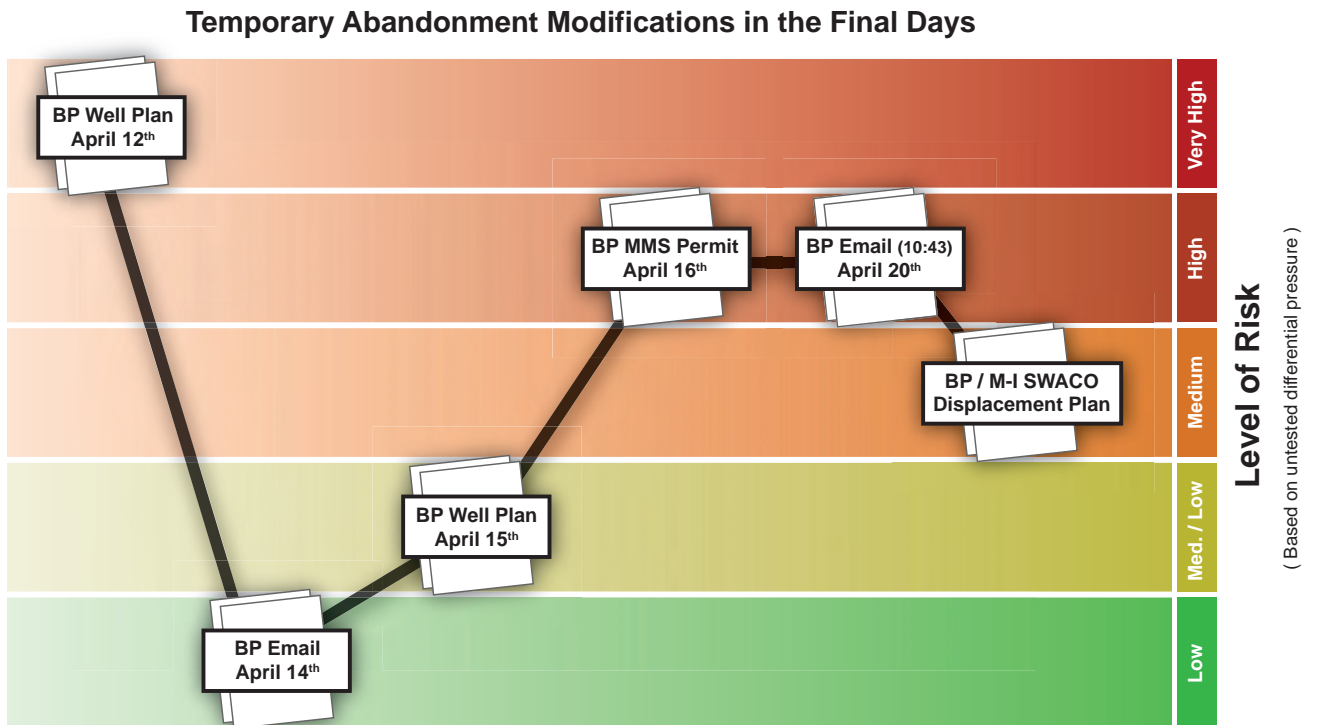

Figure 1 Temporary Abandonment Modifications, April 12–20, 2010

April 12 Temporary Abandonment Plan (See Figure 2)

The operator’s original temporary abandonment procedure was dated April 12, 2010.⁵ It directed the setting of the lock-down sleeve first to secure the production casing to the wellhead. Next, the well would be displaced with seawater to 933 ft. below the mud line, where a surface cement plug would be set. The April 12 plan did not include a negative pressure test to confirm the integrity of the cement barrier at the bottom of the well, which would have been the only (untested) barrier in place to prevent hydrocarbons from entering the wellbore when heavy drilling mud was to be removed and replaced, or displaced, with lighter seawater. See Figure 3a. The displacement phase of a temporary abandonment operation is particularly delicate as the well becomes underbalanced.

There is no indication that BP used a formal risk assessment to evaluate the April 12 plan.

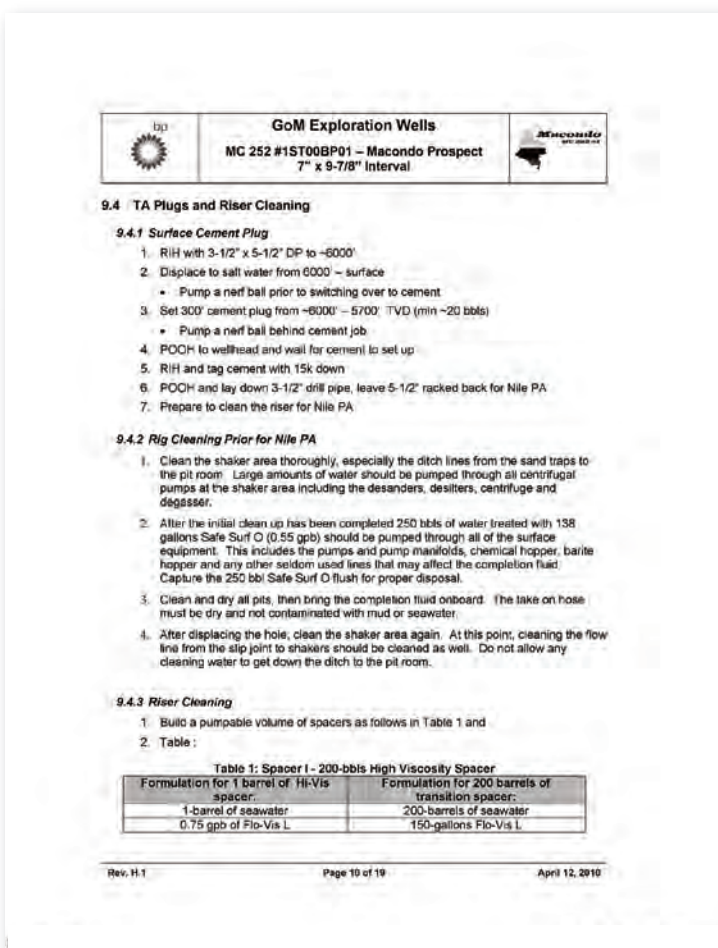
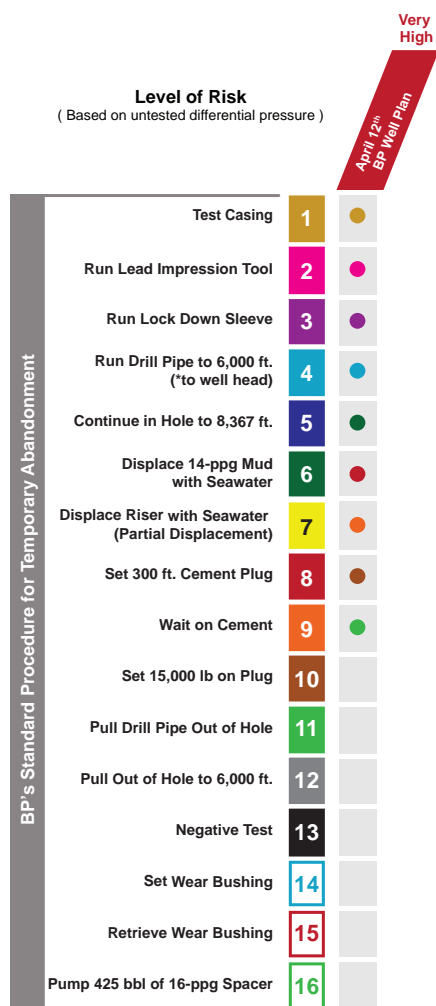

Figure 2 April 12 Temporary Abandonment Plan

Risk Associated with Procedural Changes

Increasing Risk

(Based on untested differential pressure)

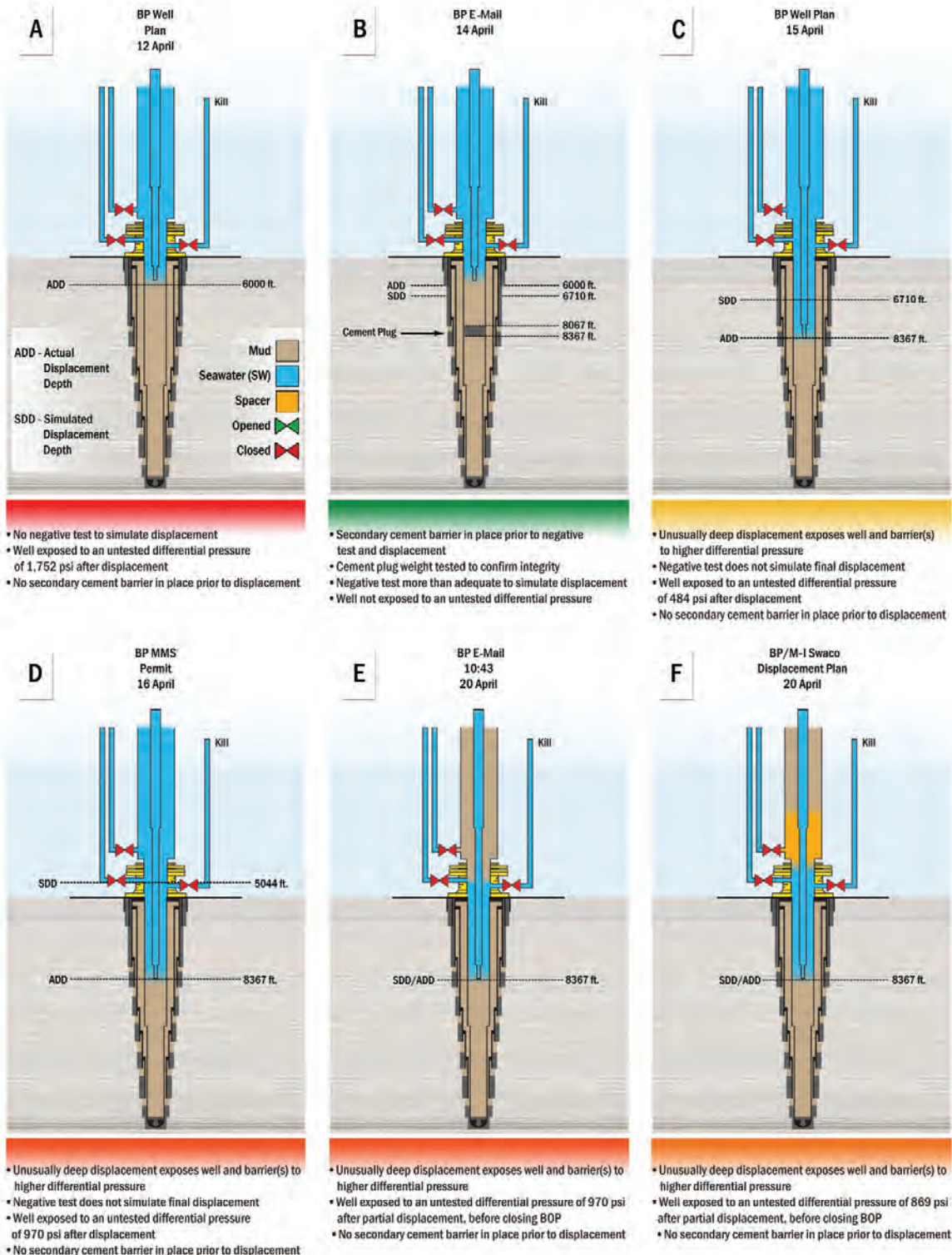

Figure 3 Risk Associated with Procedural Changes

April 14 Temporary Abandonment Plan (See Figure 4)

The April 14 version of the operator’s temporary abandonment plan was e-mailed to the BP well site leader, or “company man,” on the *Deepwater Horizon* by a shore-based engineer.⁶ The safest of all five versions, the April 14 plan dictated that a surface cement plug be set in mud and that a negative pressure test be conducted before the heavy drilling mud was displaced with seawater. It also called for installing the lock-down sleeve last, which would have eliminated the risk of damaging the device when the drill pipe was run into the well to set the surface cement plug. See appendix F for a detailed discussion of the lock-down sleeve decision.

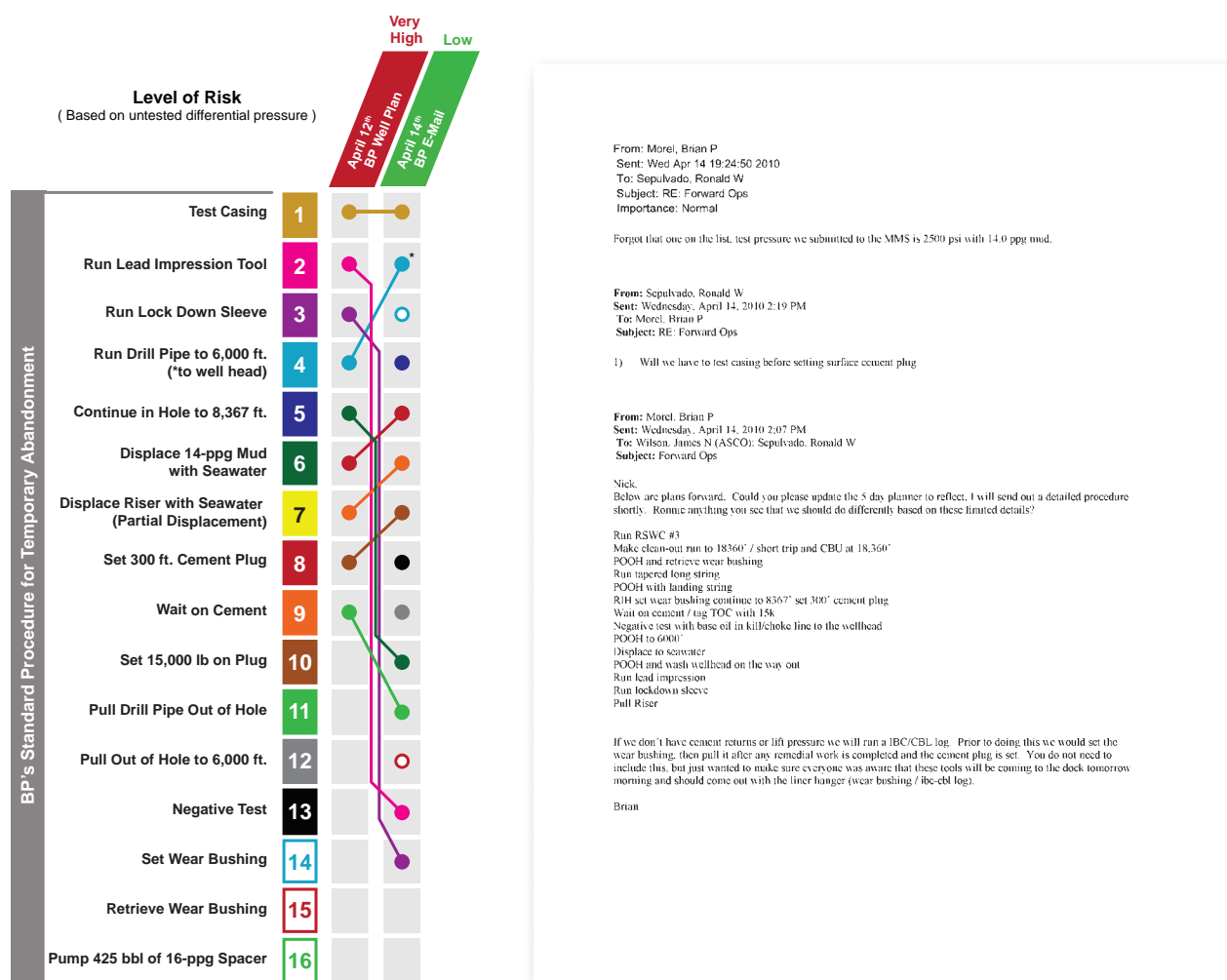

Figure 4 (a) Temporary Abandonment Plan Modifications - April 14 (b) April 14 Temporary Abandonment Plan

This plan also increased the depth from the top of the cement plug to 3,000 ft. below the mud line, significantly deeper than the MMS limit of 1,000 ft. below the mud line. That alteration (which required and eventually would receive MMS approval, though not in relation to this plan) was made to accommodate the lock-down sleeve installation. The sleeve is set in position with a running tool by applying weight, and the device manufacturer, Dril-Quip, recommends using 100,000 lb. That force is generated by hanging drill string from below the running tool. While the additional space created above the cement plug maximized the operator’s options to use varying drill strings with differing weights to reach the 100,000-lb. threshold, it remains unclear why they chose 3,000 ft. in this and subsequent plans, including on April 20, when a shallower depth could also have been used to accommodate Dril-Quip’s requirements.

While the surface cement plug would be set unusually deep in this plan,⁷ it would be set in drilling mud (rather than in seawater, as BP's final plan required). Setting the cement plug in mud, which is heavier than seawater, would significantly enhance safety by keeping the well overbalanced while the cement plug hardened and the negative pressure test was conducted.

Had the April 14 plan been followed, a secondary cement barrier, the surface plug, would have been in place prior to displacement. The April 14 plan would also have provided a more accurate simulation for the negative pressure test by creating an even greater imbalance than that anticipated when the well was abandoned, thus verifying the integrity of the barriers prior to removing the BOP stack and riser. See Figure 3b.

If implemented, this procedure should have prevented the incident as it occurred.

There is no indication that BP used a formal risk assessment to evaluate the April 14 plan.

April 15 Temporary Abandonment Plan (See Figure 5)

On April 15, BP altered the temporary abandonment plan again.⁸ Although plugs are commonly set in mud, a well site leader recommended using seawater to reduce the risk of cement contamination.⁹ This meant that the well would be displaced with seawater without a secondary barrier in place, which significantly increased the risk of the temporary abandonment operation. The well would be underbalanced with only the insufficiently tested cement at the bottom of the well, serving as a barrier to pressure in the formation.

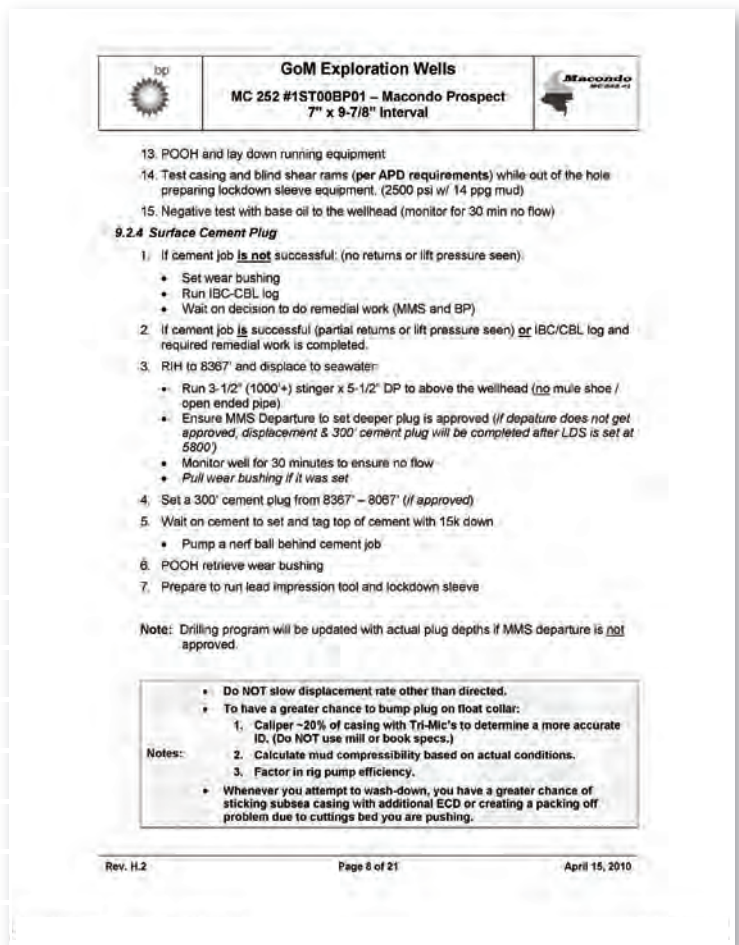
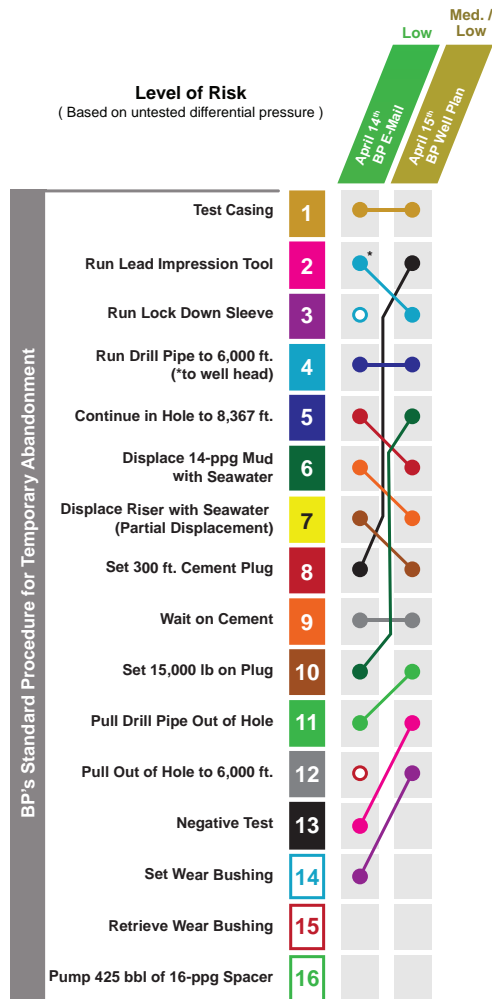

Figure 5 (a) Temporary Abandonment Plan Modifications - April 15 (b) April 15 Temporary Abandonment Plan

The unusually deep seawater displacement to the planned cement plug depth — 3,300 ft. below the mud line instead of 933 ft. — also meant that the negative pressure test would no longer be adequate to test the well to the full under balanced condition in the procedure. The April 15 procedure kept the same negative pressure test as the April 14 plan, displacing the choke or kill lines with base oil to the wellhead.¹⁰ However, because of the unusually deep seawater displacement to the planned cement plug depth, the negative pressure test would not simulate the conditions that would exist when the BOP stack and riser were removed.¹¹ Displacing the lines with base oil simulates seawater to a depth of only approximately 1,643 ft. below the mud line, significantly less than the 3,300 ft. below the mud line planned for setting the cement plug.

Because this temporary abandonment plan would have resulted in an inadequate negative pressure test prior to displacing the well, and because the well would be underbalanced with an insufficiently tested barrier, the April 15 procedure posed significant safety risks. See figure 3c.

There is no indication that BP used a formal risk assessment to evaluate the April 15 plan.

April 16 Temporary Abandonment Plan (See Figure 6)

BP adopted another plan on April 16, one that would ultimately be the MMS-approved plan.¹² In this version, the negative pressure test would be conducted with seawater rather than base oil in the kill line. The seawater would compromise the negative pressure test even further, as it would simulate a displacement with seawater to just 5,044 ft., despite the planned displacement to 8,367 ft. In addition, this plan again specified setting the surface cement plug *after* conducting the negative pressure test and displacing the well. Thus, no secondary cement barrier would be in place while conducting the negative pressure test and before the well was exposed to additional underbalance from a displacement at 8,367 ft.

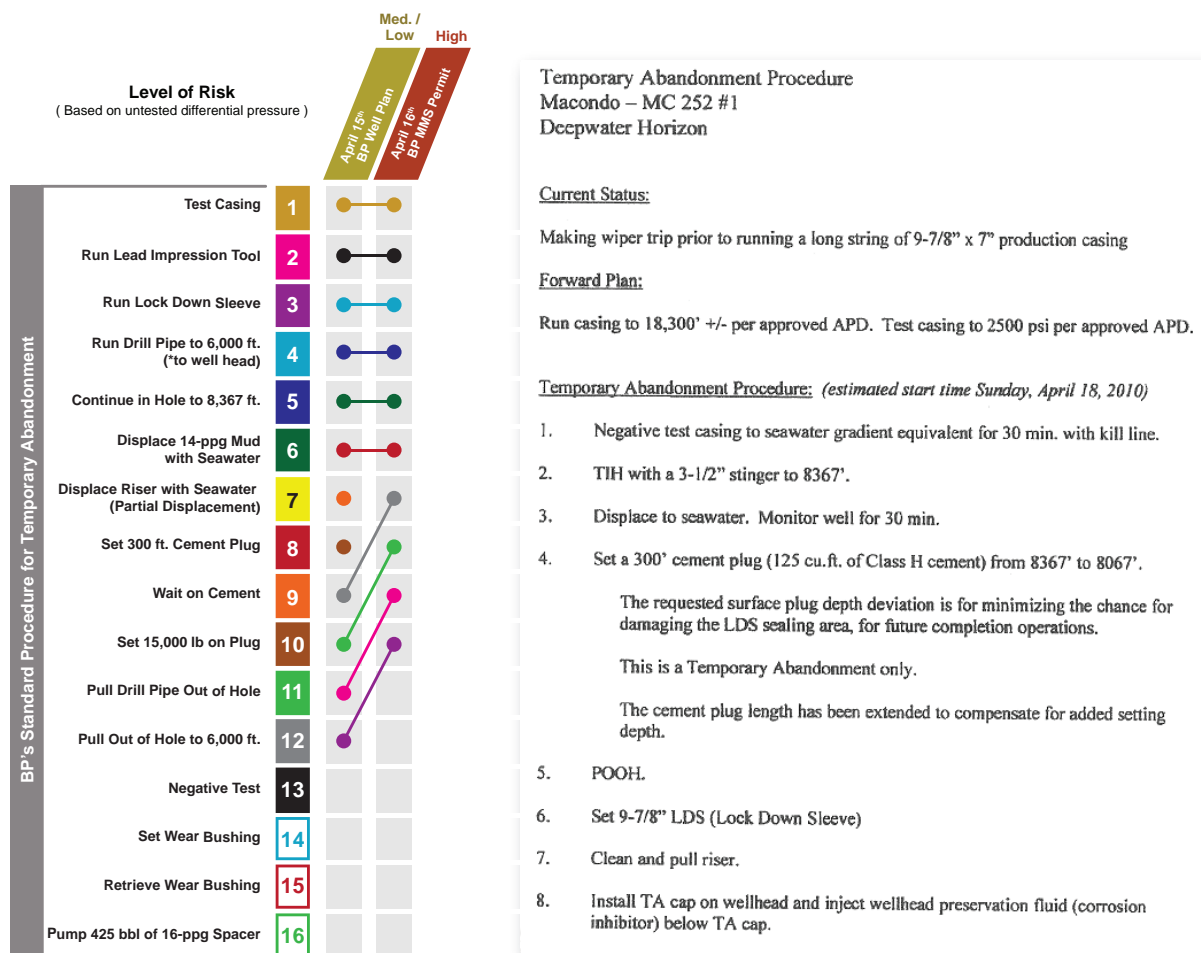

Figure 6 (a) Temporary Abandonment Plan Modifications - April 16 (b) April 16 Temporary Abandonment Plan

As with the April 14 temporary abandonment plan, this MMS-approved plan also called for setting a 300-ft. surface cement plug at a depth between 3,000 ft. and 3,300 ft. below the mud line (8,067–8,367 ft. total). This time, BP received approval from MMS to exceed the 1,000-ft. depth guidelines.¹³ Usually at that depth, plugs are weight tested.¹⁴ But because the plan defined the barrier as a “surface plug,” federal regulations did not require it to be weight tested.¹⁵ This procedure afforded time-saving benefits: As no weight testing was required, it was not necessary to wait for the cement to set before proceeding with the temporary abandonment operation. See Figure 3d.

There is no indication that BP used a formal risk assessment to evaluate the April 16 plan..

April 20 Temporary Abandonment Plan (See Figure 7)

Evidence suggests that BP determined that the April 16 MMS-approved plan did not adequately simulate actual temporary abandonment conditions and ensure an effective negative pressure test.¹⁶ As a result, the plan was altered again.¹⁷

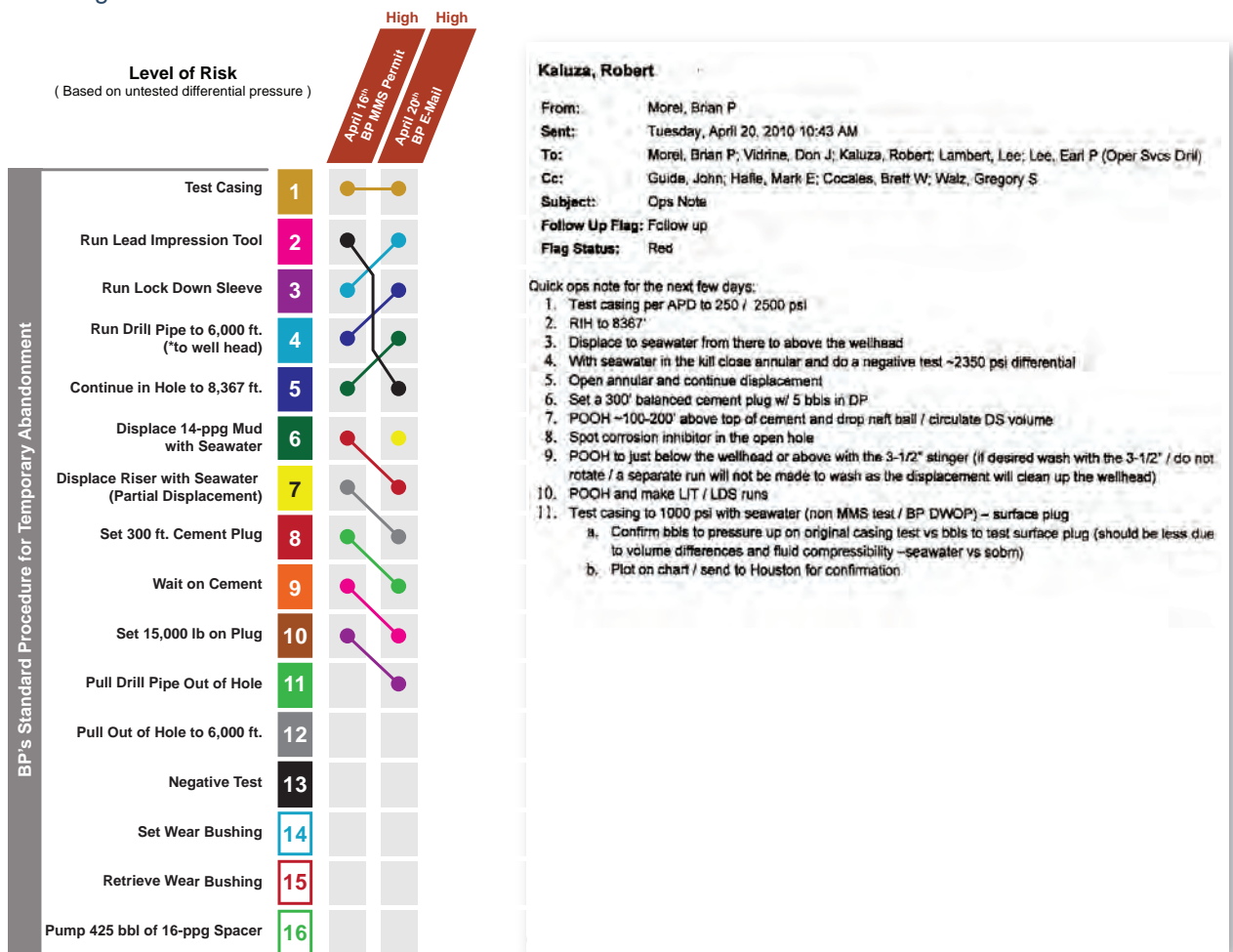

Figure 7 (a) Temporary Abandonment Plan Modifications - April 20 (b) April 20 Temporary Abandonment Plan

On April 20, at 10:43 a.m., after the temporary abandonment operation was underway, a BP engineer e-mailed a final temporary abandonment plan to the well site leader on the *Deepwater Horizon*. This plan was simply a bulleted outline with a minimum level of detail, as denoted by its title, “Quick Ops Note.” A more detailed procedure likely would have aided the well site leader and the drill crew in identifying anomalies during the temporary abandonment operation.

Furthermore, while BP never sought MMS approval for the April 20 procedure that was ultimately used — which included several changes from the MMS-approved April 16 plan — BP still anticipated monitoring the kill line during the negative pressure test as stipulated in the April 16 plan. To simulate and test conditions for the planned displacement depth of 8,367 ft., while also monitoring the kill line, the April 20 plan called for a partial displacement prior to the negative pressure test.^A With seawater in the kill line, the partial displacement would establish a continuous column of seawater to 8,367 ft., thus properly simulating conditions that would allow for the safe removal of the BOP stack and riser.

Despite properly simulating the final temporary abandonment conditions, the following decisions resulted in a procedure that contained unnecessary risk: (See Figure 3e)

- The partial displacement called for the removal of primary well control prior to closing the BOP stack and conducting the negative pressure test, and without a laboratory test confirming the cement setting properties and integrity of the cement barrier at the bottom of the well.
- Seawater displacement to 8,367 ft. (3,300 ft. below the mud line) was unusually deep and resulted in a significantly greater differential pressure across the well's only cement barrier.
- The surface cement plug would not be set until after full displacement, creating a condition where only one cement barrier would be in place while underbalancing the well.

Despite these risks, and the remaining questions about the conversion of the float collar and the laboratory test results for the cement, as noted above, there is no indication that a formal risk assessment was performed to evaluate this final temporary abandonment plan.

3.2.2 Positive Casing Test and Initial Displacement

Upon completion of the cement operations and while the temporary abandonment procedure was being finalized on April 20, 2010, the drill crew ran a tapered drill string into the hole to proceed with the displacement.¹⁸ While the drill string was at 4,817 ft., just above the BOP stack, the blind shear ram (BSR) was closed to perform a positive casing test.¹⁹

A positive casing test normally is conducted shortly after primary cementing operations are completed to assess the integrity of the casing, the seal assembly, the top cement wiper plug, and the specific BOP element used to shut in the well. A positive casing test does not provide a confirmation of the integrity of the shoe-track cement at the bottom of the well, since the pressure is against the cement wiper plug above the shoe track. The Macondo positive casing test began at approximately 11 a.m., roughly 10.5 hours after the conclusion of the primary cement job.²⁰ The casing was tested to 250 pounds per square inch (psi) for five minutes (the low-pressure test) and then to 2,700 psi for 30 minutes (the high-pressure test) with the Halliburton cement unit.²¹ The test confirmed the casing was competent, and the BSR successfully sealed.²²

After completing the positive casing test, the drill crew continued to run drill string down to 8,367 ft. (3,300 ft. below the mud line) for the displacement.²³ To displace the drilling fluid, seawater was pumped into the well to the desired depth to push the drilling mud back to the rig. Because environmental regulations prohibit the discharge of synthetic-based mud (SBM) overboard,²⁴ the drill crew made room in the rig mud storage pits to accommodate fluid returns from the well. Fluids were directed from the well to the two active mud pits on the rig, and then to the reserve pits before final transfer to the *Damon B. Bankston*, a supply vessel alongside the rig.²⁵ See Figure 8, Event 1.

A Well displacement is the act of removing one fluid from a wellbore and replacing it with another. In a partial displacement, the well (above the cement plug or planned cement plug) and riser are not fully displaced in one continuous pumping interval. Instead, part of the well is displaced initially, a break occurs during which other activities are conducted, and then later the displacement is completed in its entirety.

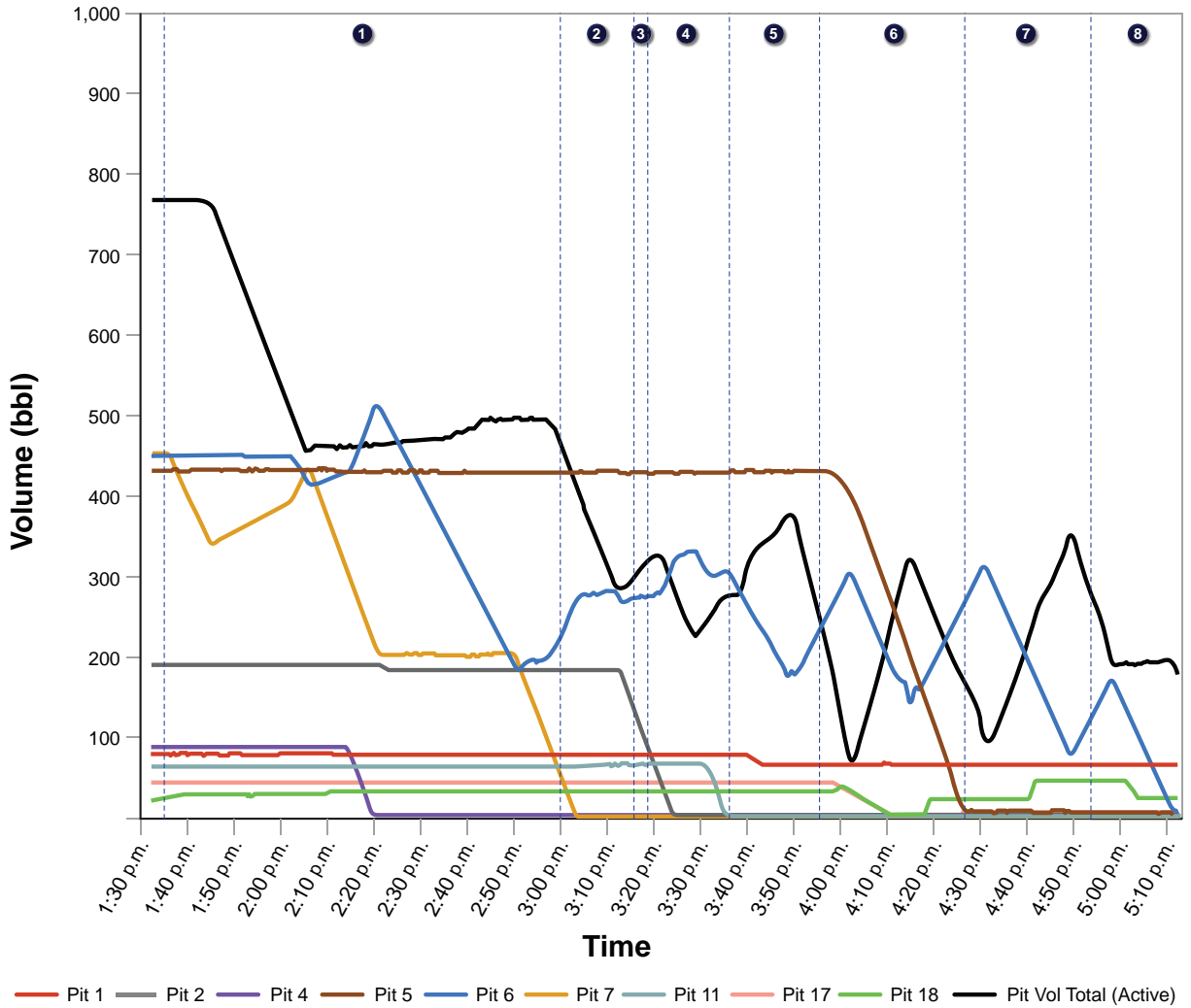

Event	Description	Time
1	Began fluid transfers to the <i>Damon B. Bankston</i> to make room for expected displacement volumes.	1:35 p.m. - 3:03 p.m.
2	Fluid transfer activity during boost line displacement.	3:03 p.m. - 3:15 p.m.
3	Fluid transfer activity while testing surface lines and drape hoses.	3:15 p.m. - 3:21 p.m.
4	Fluid transfer activity during choke line displacement.	3:21 p.m. - 3:38 p.m.
5	Fluid transfer activity during kill line displacement.	3:38 p.m. - 3:55 p.m.
6	Fluid transfer activity while pumping 16-ppg spacer.	3:55 p.m. - 4:27 p.m.
7	Fluid transfer activity while displacing 16-ppg spacer with sea water.	4:27p.m. - 4:52 p.m.
8	Final fluid transfers are made to the <i>Damon B. Bankston</i> .	4:52 p.m. - 5:10 p.m.

Figure 8 Fluid Transfer Activity from 1:35–5:10 p.m.

As shown in Figure 8, mud fluid transfers made it very difficult to accurately monitor the volumes of fluid that returned from the well during the initial displacement. Fluid transfers to the *Bankston* were completed at 5:10 p.m., soon after initial displacement stopped at 4:53 p.m.²⁶ See Figure 8, Event 8. No subsequent transfers from the *Deepwater Horizon* to the *Bankston* were made after 5:10 p.m.²⁷

SIMULTANEOUS OPERATIONS

The investigation team is aware that some sources suggest that the various activities during final displacement constituted inappropriate “simultaneous operations,” which may have interfered with the monitoring of the well. Tasks such as repairing a relief valve or dumping a trip tank commonly are performed on an offshore rig and would be considered normal in the course of operations — not simultaneous operations. The BP temporary abandonment procedure required multiple steps, which again, does not constitute “simultaneous operations” as that phrase is commonly used. The investigation team determined that after the fluid transfers to the *Bankston* were completed at 5:10 p.m., the activities of the drill crew were completed in a sequential manner, and “simultaneous operations” were not present.

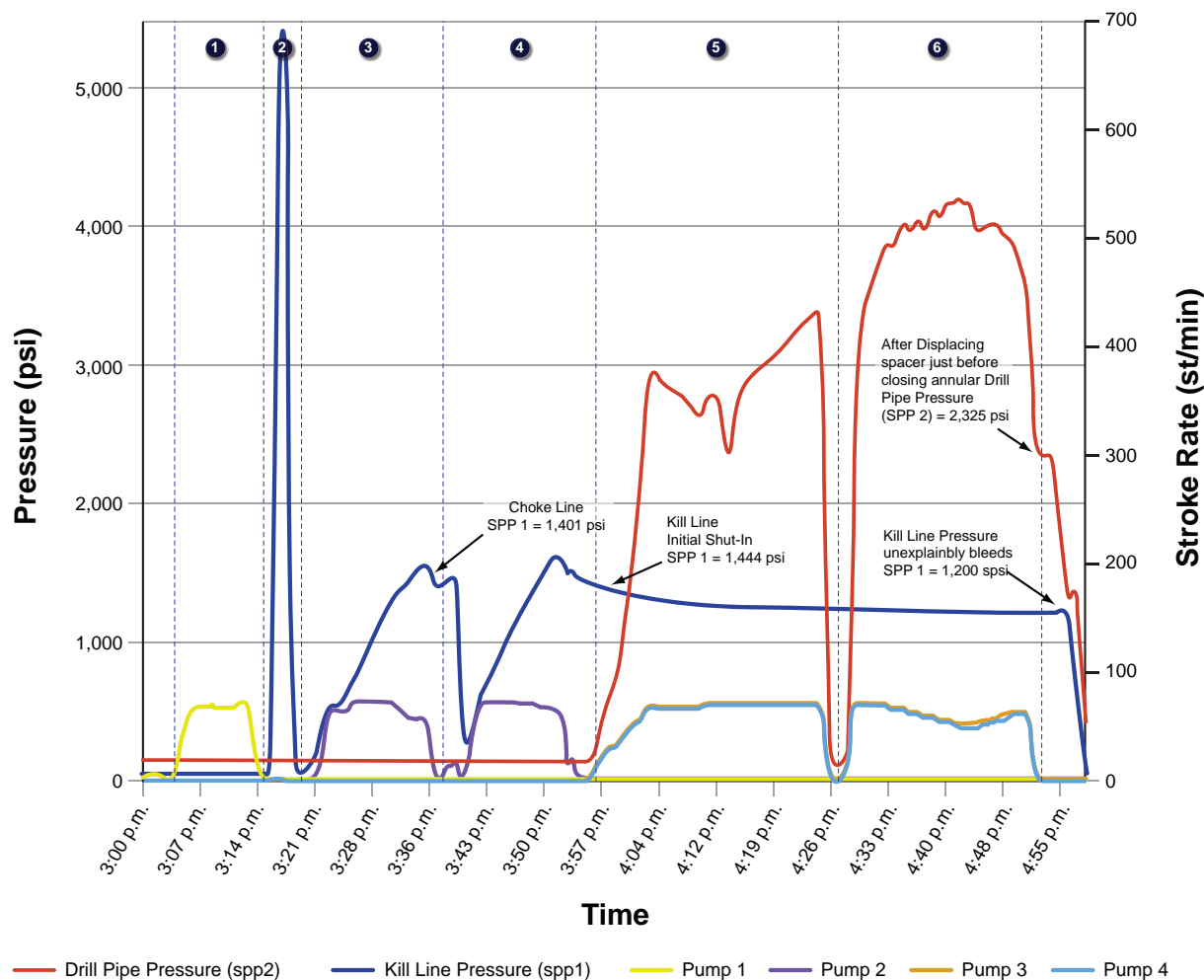

Event	Description	Time
1	Pump 1 was utilized to pump seawater from the sea chest down the boost line to displace the 14.17-ppg mud (no Sperry Sun pressure data available for the boost pump).	3:03 p.m. - 3:15 p.m.
2	Pump 2 (SPP1) was utilized to test the surface lines and drape hoses.	3:15 p.m. - 3:21 p.m.
3	Pump 2 (SPP1) pumped seawater from the sea chest down the choke line to displace the 14.17-ppg mud.	3:21 p.m. - 3:38 p.m.
4	Pump 2 (SPP1) pumped seawater from the sea chest down the kill line to displace the 14.17-ppg mud.	3:38 p.m. - 3:55 p.m.
5	Pumps 3 and 4 (SPP2) were utilized to pump 421 bbls of 16-ppg spacer from Pit 5 into the well displacing 14.17-ppg mud.	3:55 p.m. - 4:27 p.m.
6	Pumps 3 and 4 (SPP2) were used to pump seawater behind the spacer with the objective of displacing it above the BOP. The pumps were stopped and the annular BOP was closed.	4:27 p.m. - 4:53 p.m.

Figure 9 Overview of Events during the Initial Displacement from 3:03–4:53 p.m.

M-I SWACO drafted the displacement procedure for the temporary abandonment plan.²⁸

A spacer is a fluid substance designed to separate seawater from drilling mud. On the Macondo well, BP, with input from M-I SWACO, decided to use a spacer that was comprised of two materials left over on the rig from prior rig operations, specifically FORM-A-SET and FORM-A-SQUEEZE.²⁹ A lost circulation pill is a gelled, viscous, solids-laden fluid used during drilling to minimize a loss of drilling fluid to the formations; it is not designed to be used as a spacer. BP used these left over loss-circulation pills as a spacer so that they could be discharged overboard rather than sent ashore for costly disposal.³⁰

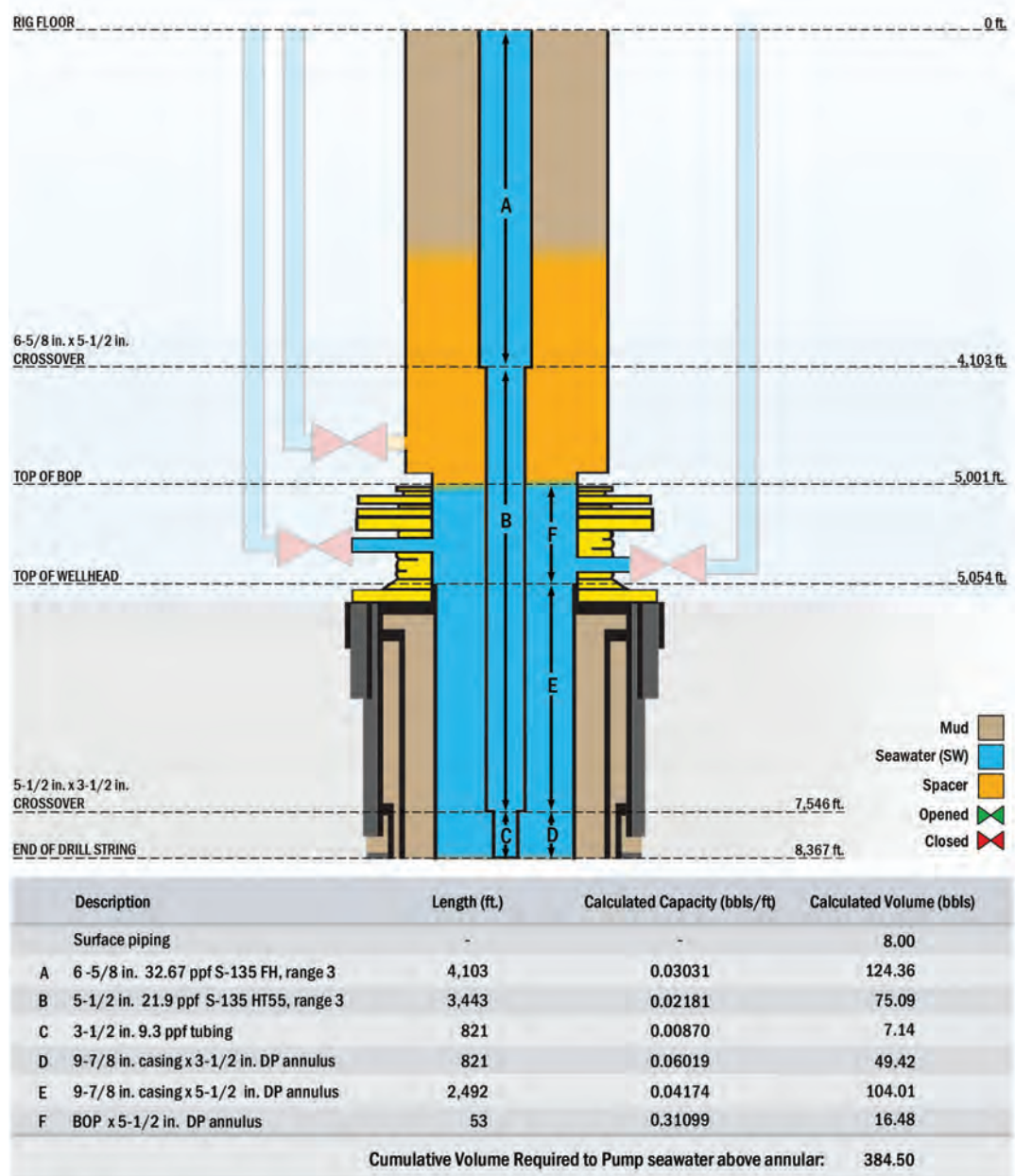

Figure 10 Volume of Seawater Necessary to Displace Spacer

BP decided to use 425 bbl of the 16-ppg spacer, more than double the average spacer volume used previously.^{31, B} The high volume of the spacer complicated the drill pipe pressure readings as the spacer moved through the well.

B The maximum volume used previously was 200 bbl. Average volumes previously used were approximately 175 bbl.

Additionally, BP and M-I SWACO mixed two materials together without prior testing or analysis and created a fluid with abnormal fluid properties for the application to which it was put. Combined with the complex wellbore and drill string geometry, the spacer attributes significantly complicated the operation, may have impacted the efficiency of the pumps, and likely created confusing pressure readings during the displacement in absence of a pump displacement curve. See Figure 3f.

In accordance with the M-I SWACO procedure, the crew first displaced the boost, choke, and kill lines with seawater.³² See Figure 9, Events 1, 3, and 4. Next, the crew pumped the spacer down the drill string^{33 c} (See Figure 8, Event 6 and Figure 9 Event 5) and then followed that with seawater in the well to displace the spacer.³⁴ See Figure 9, Event 6.

WHAT IS SPACER FLUID?

A spacer is any fluid used to physically separate one drilling fluid from another and to avoid contamination between the two. The most common spacer is water with chemicals added to enhance its performance for the particular operation. A spacer may also be oil based. Spacers are used when changing mud types and to separate mud from cement during cementing operations. To prevent unanticipated problems, the spacer should be tested with each fluid it separates in small-scale tests.

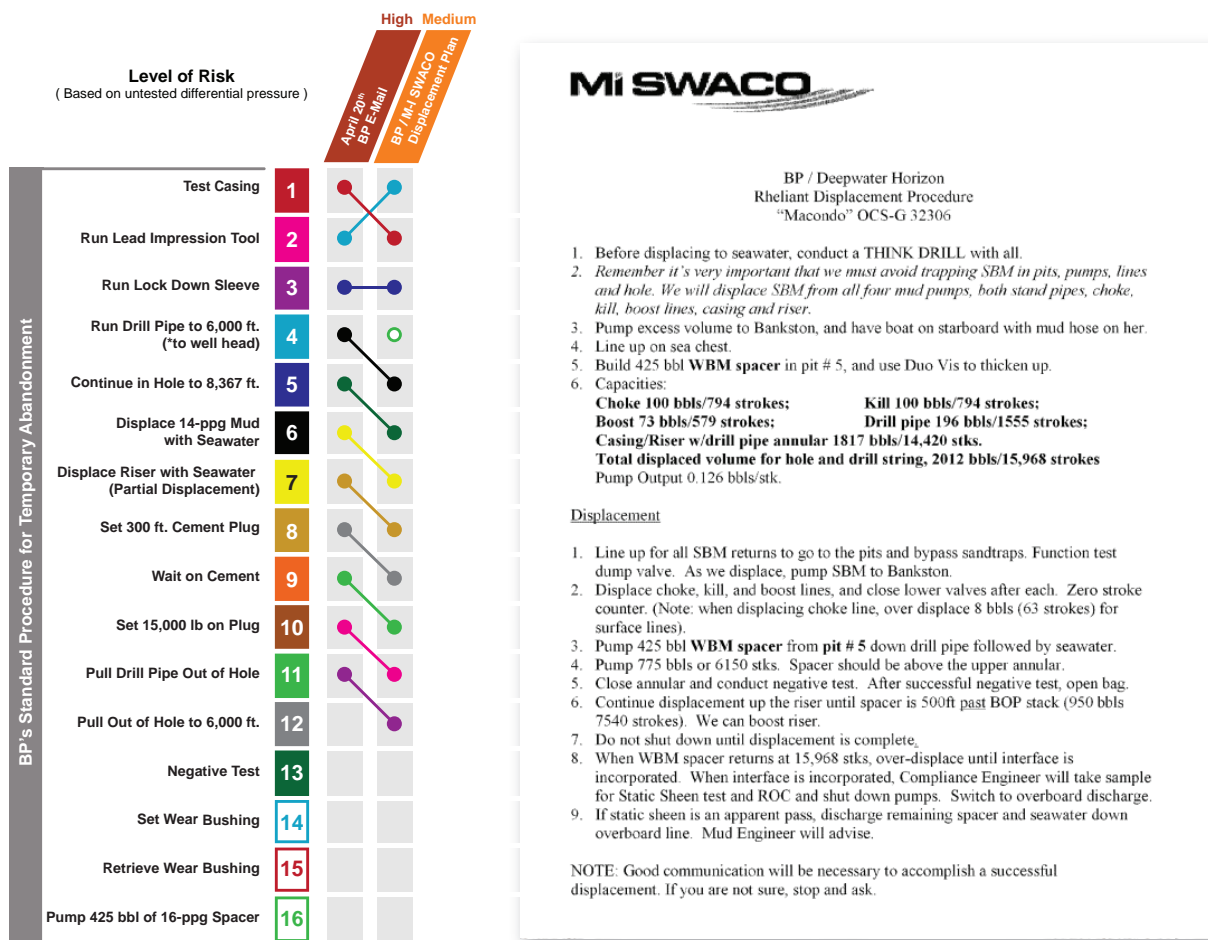

Figure 11 (a) BP April 20 Temporary Abandonment Plan versus M-I SWACO Displacement Plan (b) M-I SWACO Displacement Procedure for the Temporary Abandonment Plan

^c Although the procedure specified pumping 425 bbl of spacer, and there were 428 bbl available in pit 5, it is likely that the crew only pumped 421 bbl to avoid pumping the pit completely empty and drawing air into the pumps.

Although the objective was to move all of the spacer above the upper annular BOP element, that did not occur. The investigation team identified several factors that may have contributed to the underdisplacement of the spacer.

1. The M-I SWACO procedure called for pumping 775 bbl of fluid into the well — 425 bbl of spacer and 350 bbl of seawater — to move the spacer through the well and above the BOP stack.³⁵ (See *Figure 10*) Based on the known geometry of the well and the configuration of the drill string, the M-I SWACO calculation was incorrect; the volume of seawater necessary to displace the spacer was 385 bbl (including 8 bbl to displace surface piping).³⁶ See *Figure 11*. The procedure was 35 bbl short of the seawater required to put the spacer above the BOP stack.

Pumps 3 and 4 pumped seawater during displacement of the spacer.³⁷ See *Figure 9, Event 6*. At most, 353 bbl of seawater were pumped.³⁸ This was 3 bbl more than the procedure specified but 32 bbl less than the amount necessary to fully displace the spacer.³⁹ Based on the displacement volume specified in the procedure and amount of seawater that was pumped, 16-ppg spacer was present in the annulus below the closed annular preventer as the crew proceeded into the negative pressure test.⁴⁰

2. The *Deepwater Horizon* was equipped with four triplex positive displacement pumps. Prior to the displacement, previous operations had established that all four pumps were operating at 96.1% efficiency (0.126 bbl per stroke).⁴¹ It does not appear that there were any indications prior to the displacement that would suggest that the pumps were operating at a reduced efficiency. Even on the day of the incident, this efficiency was confirmed while displacing the primary cement with pump 3.⁴²

Based upon post-incident calculations by the investigation team, it appears that pumps 3 and 4 were operating at 89% efficiency while pumping spacer from pit 5.⁴³ See *Appendix G*. This estimated reduced pump efficiency may have been the result of the elevated rheological properties (increased viscosity) of the spacer.⁴⁴ Had the pumps continued to operate at a reduced efficiency, the actual volume of seawater pumped to displace the spacer would have been less than the assumed 353 bbl, further contributing to the amount by which the spacer was underdisplaced.⁴⁵

3. Analysis indicates that while displacing the spacer, it is possible that an estimated 27 bbl of seawater were pushed below the end of the drill pipe.⁴⁶ For that to occur, the mud below would have to have been pushed past the wiper plugs, through the failed cement, and forced into the formation, despite a positive casing test that had confirmed casing integrity.⁴⁷ Any fluid that was pushed below the drill string instead of flowing up the annulus would only have further contributed to the spacer being underdisplaced.

Had the spacer been displaced above the annular BOP, the drill pipe pressure should have been 1,572 psi when the pumps were shut down and the lower annular BOP element was closed at 4:53 p.m.⁴⁸ See *Figure 13a*. Had the underdisplacement been the result of the calculation errors alone, the drill pipe pressure would have been 1,923 psi.⁴⁹ See *Figure 13b*. Instead, the actual pressure recorded was 2,325 psi, which indicates the spacer had been under displaced and suggests that it was not just a result of calculation errors, but also seemingly lower pump efficiencies and potential downhole losses.⁵⁰ See *Figure 13c*. The additional heavy fluid that remained in the well below the annular BOP as a result of the underdisplacement resulted in a higher drill pipe pressure. The displacement procedures gave no guidance as to what the drill pipe pressure should have read when the mud pumps were turned off before the negative pressure test.⁵¹ There also was an apparent inability to track the volume of mud returning from the well compared to the theoretical volume pumped into the well. These factors caused the underdisplacement of the spacer to go unidentified.

Figure 12 illustrates how BP’s five temporary abandonment plans and the M-I SWACO displacement plan changed and compared to BP’s standard procedures for temporary abandonment. As can be seen, the plans varied significantly from each other and from BP’s standard protocol, and introduced risk and confusion into the final procedure.

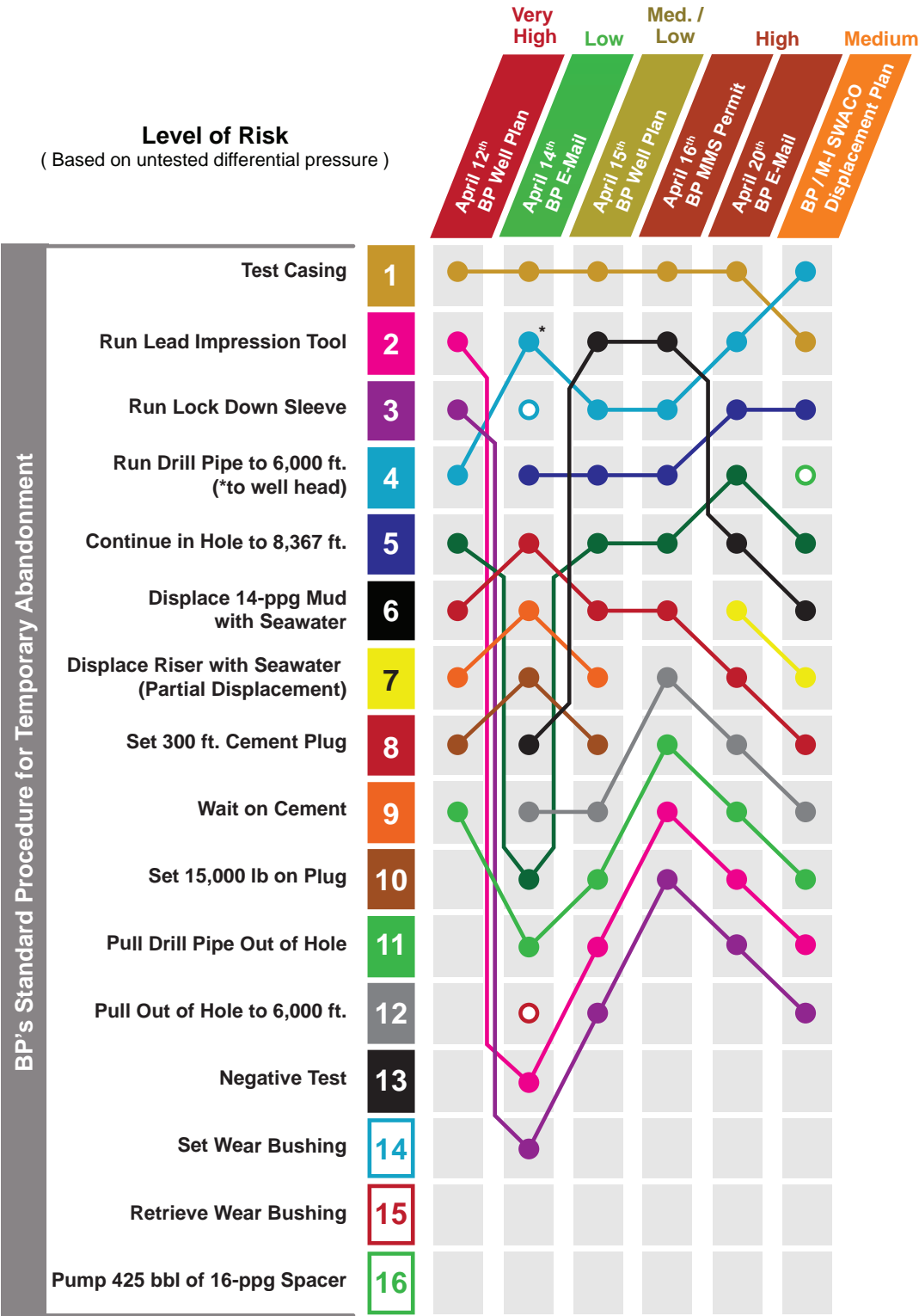

Figure 12 Lifecycle of BP’s Temporary Abandonment Plan Modifications from April 12 to April 20, 2010, and MI-SWACO Displacement Plan, as Compared to BP Standard Procedure for Temporary Abandonment

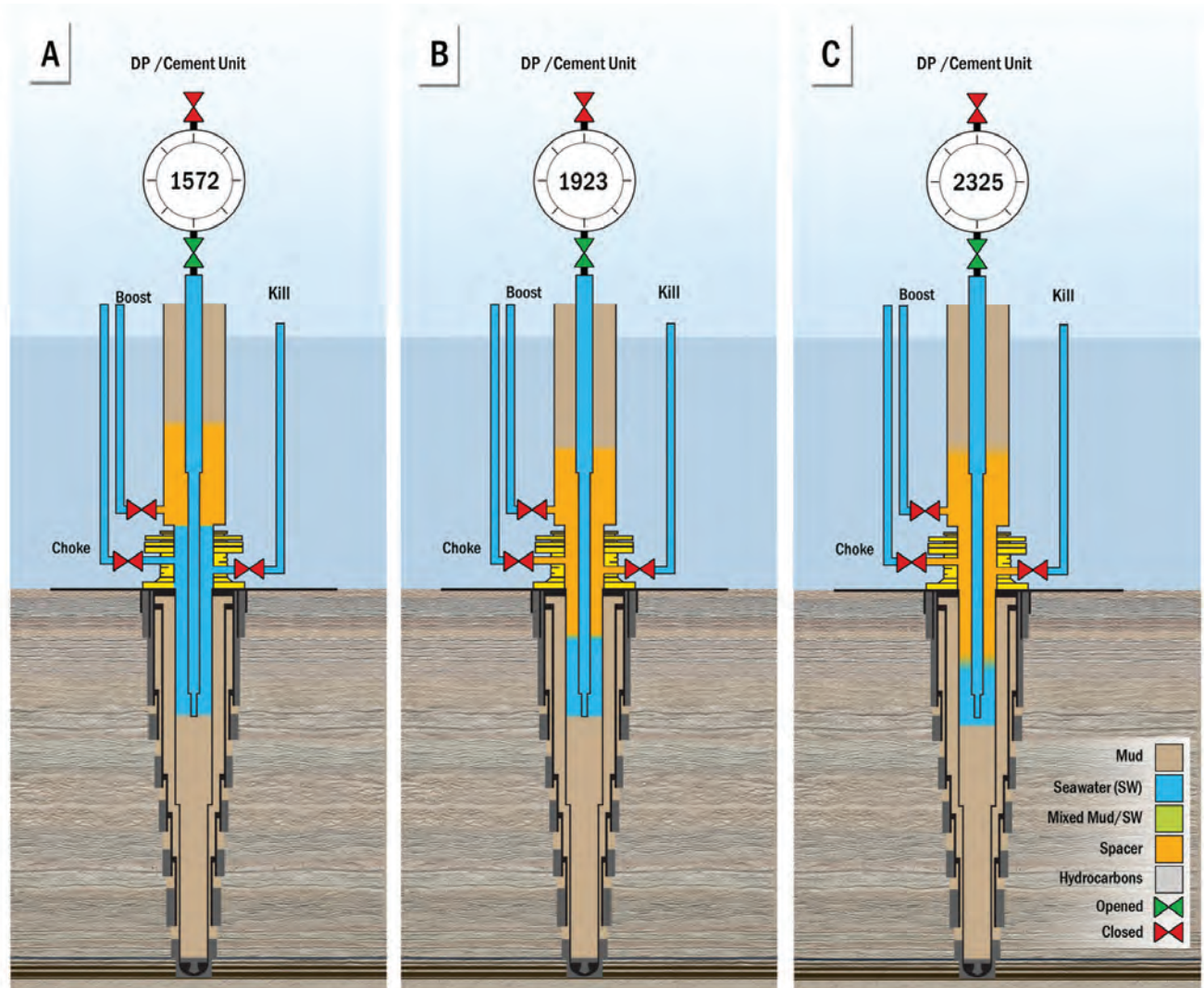

Figure 13 (a) Represents the planned partial displacement with the spacer above the BOP. (b) Represents underdisplacing the spacer by 32 bbl as a result of the calculation errors in the displacement procedure. (c) Represents the pressure observed after turning off the pumps and closing the annular, and suggests that the spacer was underdisplaced by more than just 32 bbl as a result of calculation errors, seemingly lower pump efficiencies, and potential downhole losses.

3.2.3 Negative Pressure Test

Before the *Deepwater Horizon* could depart from the Macondo well, it was necessary to conduct a successful negative pressure test to ensure that the float collar valves, casing, and cement in the well would prevent hydrocarbons from entering the wellbore. A negative pressure test is a critical operation conducted by simulating the condition of the well that would exist after the riser and BOP are disconnected from the well. To conduct a negative pressure test, the well is shut in, a light-weight fluid such as sea water or base oil is pumped into the well, pressure in the drill pipe or an auxiliary line (such as the kill line in this case) is bled off, and the well is monitored to determine whether any hydrocarbons from the surrounding formation leak into the well. There is no established industry standard or MMS procedure for performing a negative pressure test.

As operator, BP was responsible for determining the design of the negative pressure test and determining whether the negative pressure test was successful before proceeding with the temporary abandonment plan. BP well site leaders were responsible for overseeing the negative pressure test and would be expected to consult with the operator's onshore engineers.^D The Transocean drill crew set up and conducted the negative pressure test. Every member of the drill crew would be expected to stop work if he or she believed that the results of the negative pressure test posed a safety risk. The investigation was not able to find evidence that the drill crew was provided information by BP relating to the modifications to the abandonment procedure, or the impact that the use of the unusual spacer would have on pressure readings during displacement.

The drill crew began setting up the negative pressure test around 3 p.m. on April 20, 2010. It was not finally approved as successful by the BP well site leaders until close to 8 p.m. It is now clear that the negative pressure test conducted on April 20, 2010, should not have been approved as a successful test. The anomalous pressure observed on the drill pipe during the test should have confirmed that the cement barrier was not effective, pressure was being transmitted past the cement and float equipment, and the well was in communication with the formation.

The investigation team concluded that several factors may have contributed to the incorrect interpretation of the test, including the following:

- The presence of a high volume of space below the annular BOP
- BP's insistence that the drill crew monitor the kill line (which contained heavy drilling fluid) as specified in the approved MMS permit, despite the 1,400-psi pressure reading on the drill pipe
- The change during the course of the test from monitoring the drill pipe to monitoring the kill line as ordered by the well site leader

To simulate the final displacement at 3,300 ft. below the mud line while also monitoring the kill line, as specified in the April 16 MMS-approved procedure and adopted in the April 20 procedure, a continuous column of seawater was required in both the kill line and the casing annulus below the BOP down to the test depth of 8,367 ft.⁵² As shown in *Figure 14*, this would properly simulate the reduction in hydrostatic pressure that occurs when the heavier mud is displaced with lighter seawater and the BOP stack and riser are disconnected.

With mud or spacer remaining in the kill line or in the annulus, the negative pressure test would not have accurately simulated the planned final underbalanced displacement condition. Therefore, monitoring the kill line for flow or pressure during the negative pressure test would not have produced reliable data for the operator's use in interpreting the test.

Figure 15 illustrates the events that occurred during the negative pressure test. *Figure 16* shows a simplified schematic of the assumed test setup configuration that was used during the negative pressure test.

After the lower annular BOP element was closed, the pressure on the drill pipe was 2,325 psi, and the pressure on the kill line was approximately 1,200 psi.⁵³ See *Figure 17* and *Figure 15, Event 1*. At this time, the drill pipe and the kill line were closed off from one another by a subsea kill valve at the BOP stack, and the pressure on the drill pipe was bled down to equalize with the kill line pressure. When the drill pipe was opened and 18–25 bbl of fluid were bled from the drill pipe, the drill pipe pressure decreased to 1,250 psi.⁵⁴ See *Figure 15, Event 2*.

Analysis indicates that the bleed volume was higher than anticipated, likely a result of the differential pressure that existed across the lower annular BOP element.^E The annular is not designed to hold pressure above, and it likely did not maintain a seal. Thus, some of the spacer moved below the annular.^{55 F} The spacer that moved below the annular pushed additional fluid out of the drill pipe, which increased the bleed volume.

D Experts from other operators in the industry testified before the National Commission on the BP *Deepwater Horizon* Oil Spill and Offshore Drilling "that industry practice requires the Well Site Leader to make the final decision regarding whether the test has passed or failed." See Chief Counsel's Report, National Commission on the BP *Deepwater Horizon* Oil Spill and Offshore Drilling at § 4.6, 159.

E The positive casing test that was conducted on April 20, 2010, required 6-1/2 bbl to increase the pressure within the well to 2,700 psi. Based on the linear relationship between pressure and volume, the required volume to bleed the pressure from 2,325 psi to 1,250 psi is estimated to be between 2–3 bbl.

F When the subsea engineer increased the operating pressure of the lower annular a few minutes later, it appears that the fluid in the riser stopped falling, and the crew was able to successfully refill the riser.

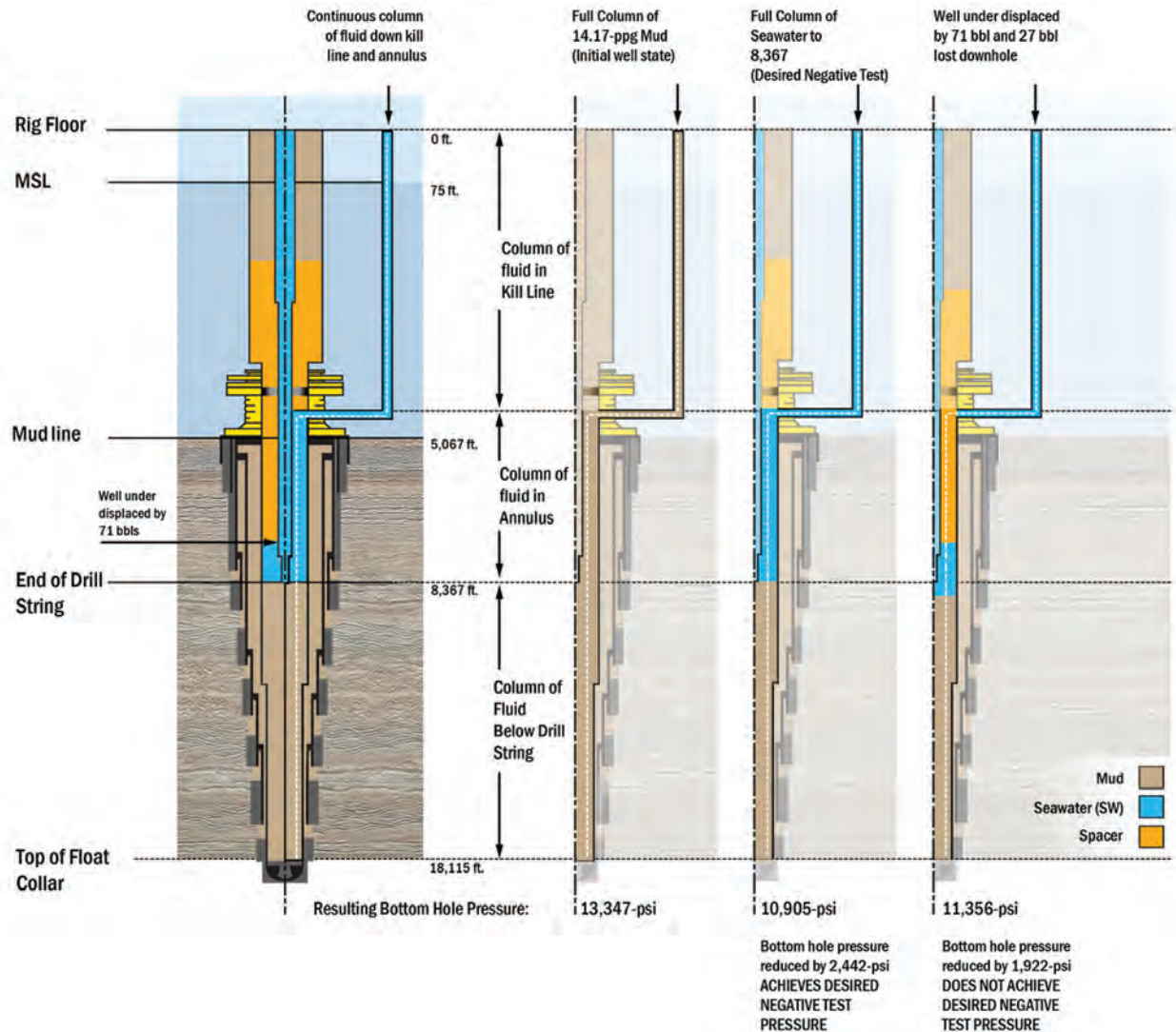
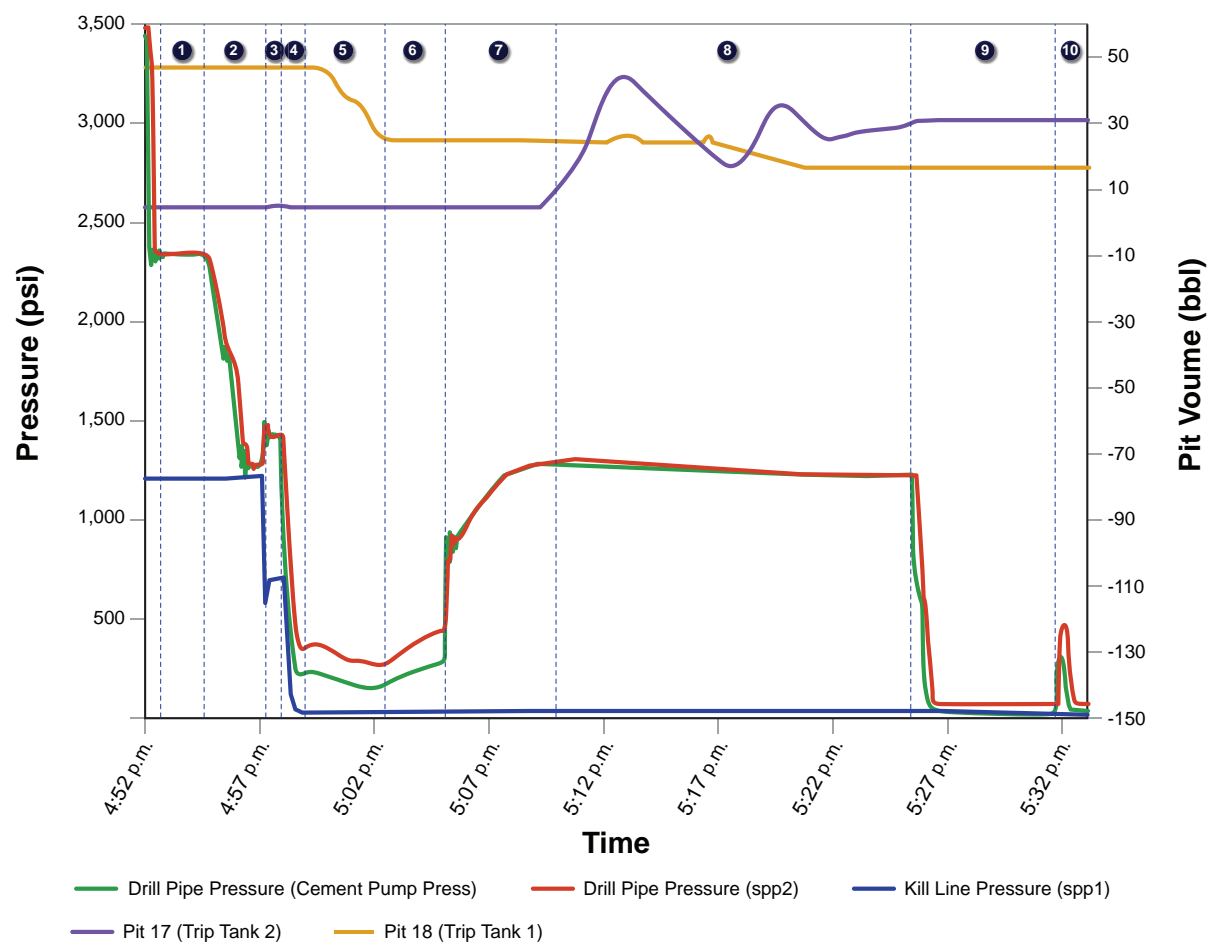

Figure 14 Columns of Fluid with Different Densities Result in Different Bottom Hole Pressures

After the drill pipe pressure was bled down to equalize with the kill line pressure, the subsea kill valve was opened.⁵⁶ With the drill pipe and kill line in communication, a so-called U-tube effect occurred whereby the height or pressure of one leg of fluid is changed when put in communication with fluid in another leg. In this case, the drill pipe pressure increased to 1,395 psi and the kill line pressure decreased to 682 psi.⁵⁷ See Figure 15, Event 3. This difference in pressure provides evidence that heavy fluid was present in the annulus.⁵⁸ See Figure 18. With the valve open, the column of fluid on the kill line side acted against the column of fluid in the drill pipe. Had a continuous column of seawater existed on both the kill line side and drill pipe side to a depth of 8,367 ft., the pressure on the drill pipe and the kill line would have been equal.

The drill pipe was opened and additional fluid was bled from the drill pipe to intentionally underbalance the well and test the barriers in place.⁵⁹ See Figure 15, Event 4. A trip tank, a small mud tank used to monitor fluid levels within the wellbore while the mud pumps are turned off, was lined up to monitor the fluid level in the riser.⁶⁰ Once lined up, the fluid level in the trip tank began to decrease immediately, confirming that fluid in the riser was falling and moving below the lower annular BOP element.⁶¹ See Figure 15, Event 5.

The heavy fluid in the annulus and the continued movement of fluid through the annular BOP prevented the drill pipe pressure from being bled to 0 psi.⁶² As seawater was bled from the drill pipe, fluid continued to move below the annular BOP. The drill crew ceased pumping fluid from the trip tank into the riser.⁶³ See Figure 15, Event 6.



Event	Time	Description
1	4:53 p.m. 4:54 p.m.	After the initial displacement is completed the mud pumps are shut down and the annular is closed.
2	4:54 p.m. 4:57 p.m.	The drill pipe is opened and an estimated 18 -25 bbl of fluid are bled from the drill pipe, and the drill pipe pressure (CPP) decreases to 1,250 psi. The drill pipe is then shut-in.
3	4:57 p.m. 4:58 p.m.	The subsea kill valve is opened to allow the pressure in the drill pipe and on the kill line to equalize. The drill pipe pressure (CPP) increases to 1,395 psi and the kill line pressure decreases to 682 psi (SPP1).
4	4:58 p.m. 4:59 p.m.	Continue bleeding seawater from the drill pipe. The kill line pressure (SPP1) bleeds to 0 psi while the drill pipe pressure (CPP) decreases to approximately 340 psi. The well becomes underbalanced to the formation.
5	4:59 p.m. 5:02 p.m.	Continue bleeding seawater from the drill pipe. The drill pipe pressure (CPP) decreases to approximately 240 psi before increasing. While bleeding pressure the trip tank is lined up to monitor the riser fluid level, and begins to immediately lose fluid indicating the 16 ppg spacer was moving below the closed annular BOP.
6	5:02 p.m. 5:05 p.m.	Continue bleeding seawater from the drill pipe. The trip tank is turned off but the fluid level in the riser continues to fall and move below the annular allowing additional 16 ppg spacer to enter the annulus below the closed annular BOP. The drill pipe pressure (CPP) begins to increase.
7	5:05 p.m. 5:09 p.m.	The drill pipe is shut in and the drill pipe pressure (CPP) rapidly increases to 900 psi. The pressure (CPP) continues to gradually increase to a maximum pressure of 1,250 psi. The annular preventer is sealed preventing any further movement of 16 ppg spacer below the closed annular BOP.
8	5:09 p.m. 5:26 p.m.	The drill pipe pressure (CPP) stabilizes at 1,202 psi. The pit data shows that a total of 65 bbl of fluid were pumped from the trip tanks to fill the riser.
9	5:26 p.m. 5:32 p.m.	The drill pipe is opened and approximately 15 bbl of seawater are bled from the drill pipe. The drill pipe pressure (CPP) decreases to approximately 0 psi and the well becomes underbalanced to the formation.
10	5:32 p.m. 5:34 p.m.	With the drill pipe still open, the subsea kill valve and the surface kill valve are opened. The heavy fluid in the annulus u-tubes resulting in flow out of the drill pipe and an increase in drill pipe pressure. Shortly after bleeding the pressure, valves are closed isolating the drill pipe pressure gauges (CPP, SPP2) and allowing the drill pipe pressure to bleed to approximately 0 psi.

Figure 15 Overview of Events during the Negative Pressure Test from 4:53–5:34 p.m.

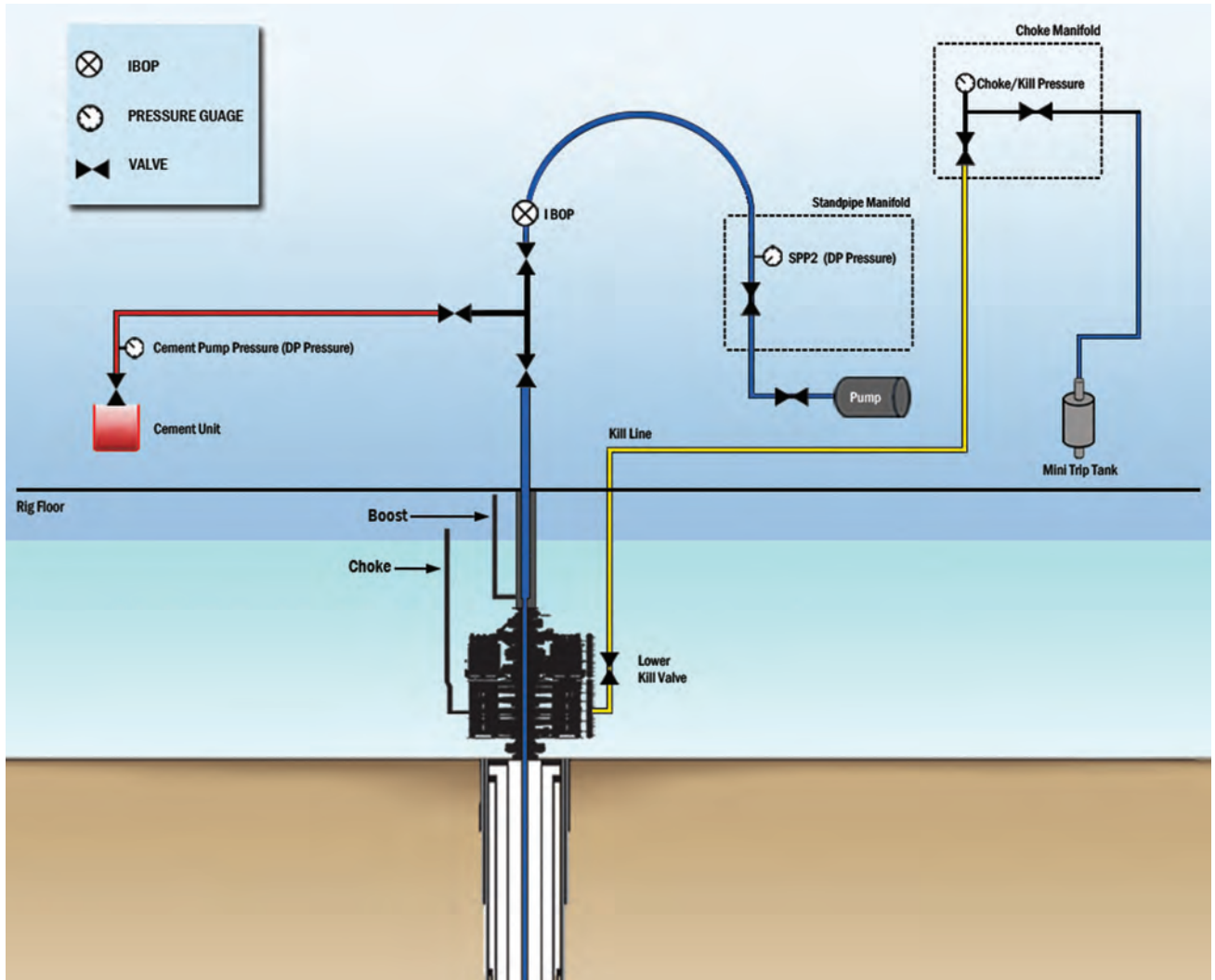

Figure 16 Simplified Schematic of the Assumed Line-up Configuration Used during the Negative Pressure Test

The drill pipe was shut in, and the heavy fluid in the annulus rapidly pushed the drill pipe pressure to 900 psi.⁶⁴ See Figure 15, Event 7. Once the drill pipe pressure stabilized, the pressure gradually increased to 1,250 psi.⁶⁵ See Figure 19 and Figure 15, Event 7. The annular closing pressure was then increased, preventing any further movement of fluid below the closed annular BOP.⁶⁶

Based on the total volume of fluid pumped from the trip tank into the riser, the team calculated that 65 bbl of spacer moved below the annular.⁶⁷ See Figure 15, Events 5 and 8. Estimates of the initial underdisplacement combined with the total volume of fluid that moved below the annular indicate there were 136 bbl of spacer below the annular.⁶⁸

The on-duty BP well site leader arrived on the rig floor while a visual inspection of the riser fluid level was being conducted and shortly after the drill pipe pressure stabilized at 1,250 psi.⁶⁹ In discussions about the drill pipe pressure and the method of conducting the negative pressure test, the BP well site leader stated that the 1,250 psi observed on the drill pipe was likely a U-tube effect.⁷⁰

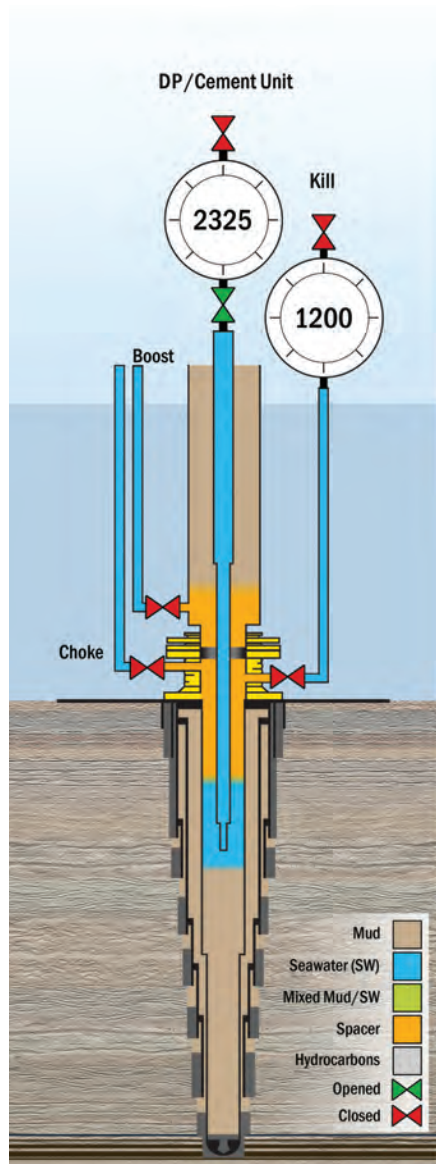

Figure 17 Initial Displacement Complete and Annular Closed

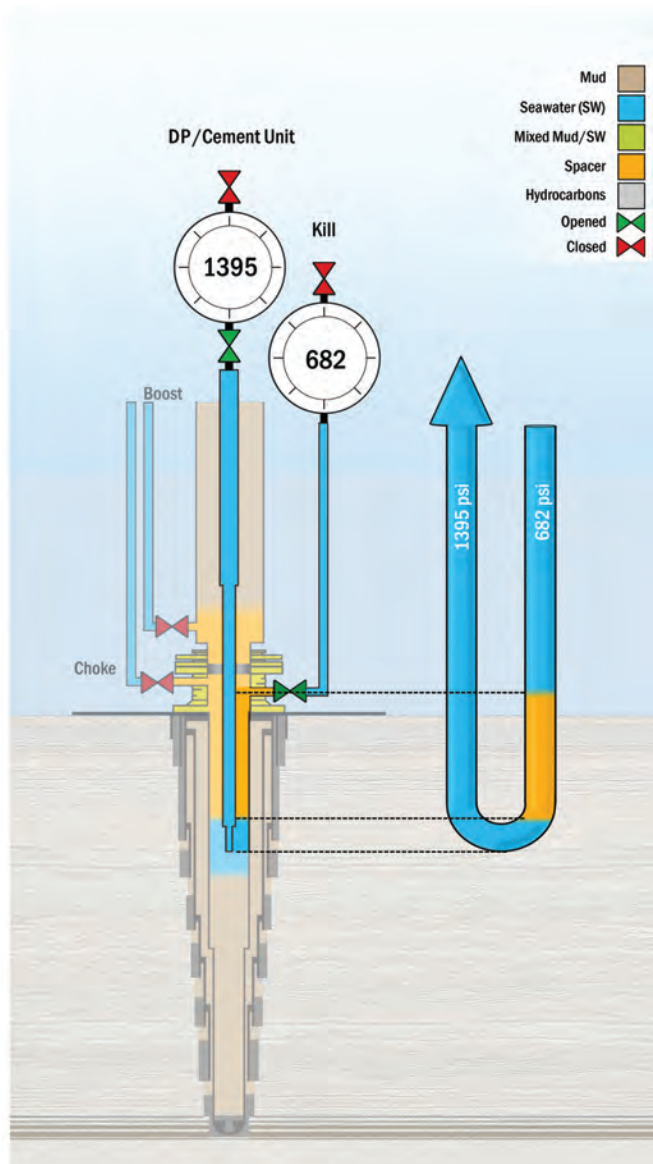

Figure 18 Attempt to Equalize Drill Pipe and Kill Line Pressures, Resulting in U-Tube Effect

The BP well site leader then directed the drill crew to bleed the drill-pipe pressure to 0 psi.⁷¹ The drill crew underbalanced the well a second time, bleeding approximately 15 bbl of seawater from the drill pipe to bring the drill pipe pressure to 0 psi for monitoring.⁷² See *Figure 15, Event 9*. However, with the drill pipe still open, the BP well site leader instructed the drill crew to switch from monitoring the well on the drill pipe to monitoring on the kill line as specified in the approved MMS plan.⁷³ Consequently, at 5:32 p.m., the drill crew opened the kill valves, and the heavy fluid in the annulus fell, pushing fluid up and out of the drill pipe to the cement unit.⁷⁴ See *Figure 15, Event 10*. The Halliburton cementer called the rig floor, stating that 3–4 bbl of seawater had flowed back to the cement unit.⁷⁵ Upon post-incident review, this data further confirms heavy fluid in the annulus below the closed annular BOP.

The BP well site leader directed the crew to shut in the well and left the rig floor to confer with the off-duty well site leader.⁷⁶ This temporarily isolated the gauges monitoring the drill pipe pressure, thereby preventing detection of a subsequent build up in well pressure.⁷⁷ See *Figure 17 and Figure 20, Event 11*.

At around this time, a BP well site leader directed the crew to complete the negative pressure test by monitoring the flow on the kill line per the MMS-approved plan.

At 5:52 p.m., a valve was opened, exposing the drill pipe pressure gauge located on the cement unit to the pressure that had built up in the well.⁷⁸ See *Figure 20, Event 12*. The drill pipe pressure gauge rapidly increased to 770 psi.⁷⁹ The drill pipe pressure then was bled a third time, and the well was shut in at 6 p.m.⁸⁰ The drill pipe pressure increased to approximately 1,182 psi.⁸¹ See *Figure 20, Event 13*. At 6:34 p.m., a slight pressure increase was recorded on the kill line, suggesting the subsea kill valve was open.⁸² Post-incident analysis indicates that within a few minutes, the drill pipe pressure had increased to 1,400 psi, and the kill line pressure had increased to 137 psi.⁸³ This suggests to the investigation team that a barrier had failed, and the well was in communication with the formations.⁸⁴ See *Figure 20, Event 14*.

“IN COMMUNICATION WITH THE FORMATION”

During drilling operations, the wellbore is in communication with the formation and is monitored for losses to and/or gains from the formation. The wellbore is expected to remain in communication with the formation until a barrier has been set. After a successful barrier is set, the formation is isolated from the wellbore and no longer is in communication. When in communication with the formation, the wellbore may or may not experience losses or gains. For example, a mud column generating effective hydrostatic pressure will prevent gains or losses even though the well is in communication with the formation.

After the pressure stabilized at 1,400 psi, both BP well site leaders arrived at the rig floor.⁸⁵ One of the BP well site leaders instructed the drill crew to pump down the kill line to ensure that it was full.⁸⁶ At 6:41 p.m., the drill crew pumped approximately 0.25 bbl into the kill line, and the kill line pressure immediately increased to 489 psi, suggesting that the kill line was full.⁸⁷ See *Figure 20, Event 15*.

Discussions resumed regarding the drill pipe pressure anomalies and the method of monitoring the well for the negative pressure test.⁸⁸ See *Figure 20, Events 15 and 16*. One of the BP well site leaders departed the rig floor to call shore.⁸⁹ Although there is disagreement, witnesses have indicated that he spoke to BP onshore engineers or supervisors about the negative pressure test.⁹⁰ The BP well site leader was directed to return to the rig floor and complete the negative pressure test.⁹¹

At 7:15 p.m., the drill crew bled pressure from the kill line and conducted the negative pressure test by monitoring the mini trip tank for flow from the kill line, even though the pressure on the drill pipe still registered 1,400 psi.⁹² See *Figure 22 and Figure 20, Event 17*. At this point, post-incident calculations indicate that pressure from the formations would have been greater than the downward pressure of the heavy fluid in the annulus.⁹³ Under such conditions, flow should have been visible from the kill line.⁹⁴ Because flow was not observed, the kill line or subsea kill valve may have been plugged with spacer, or the valve configuration may have prevented the flow to the mini trip tank.⁹⁵

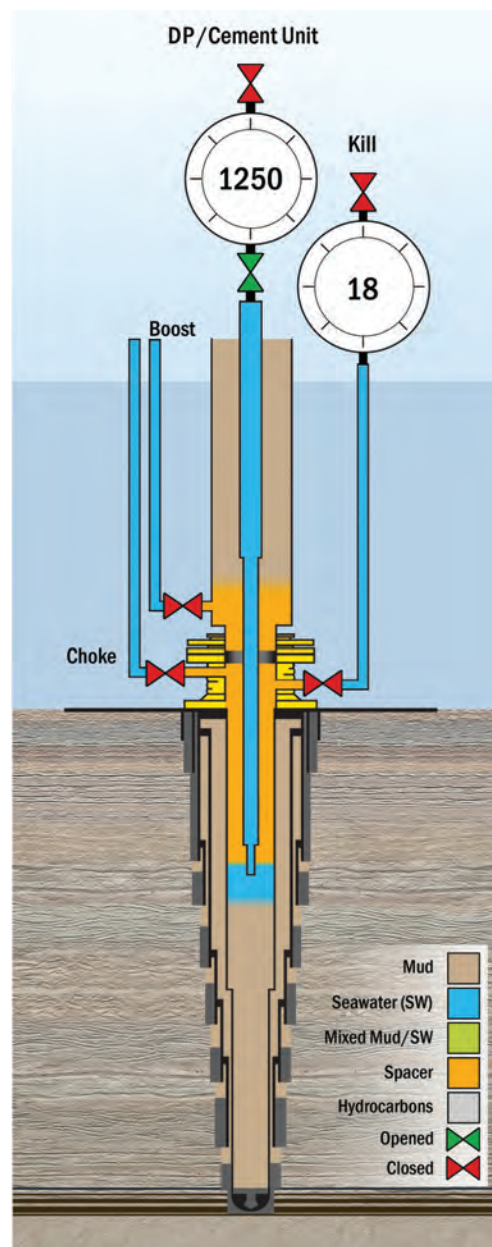
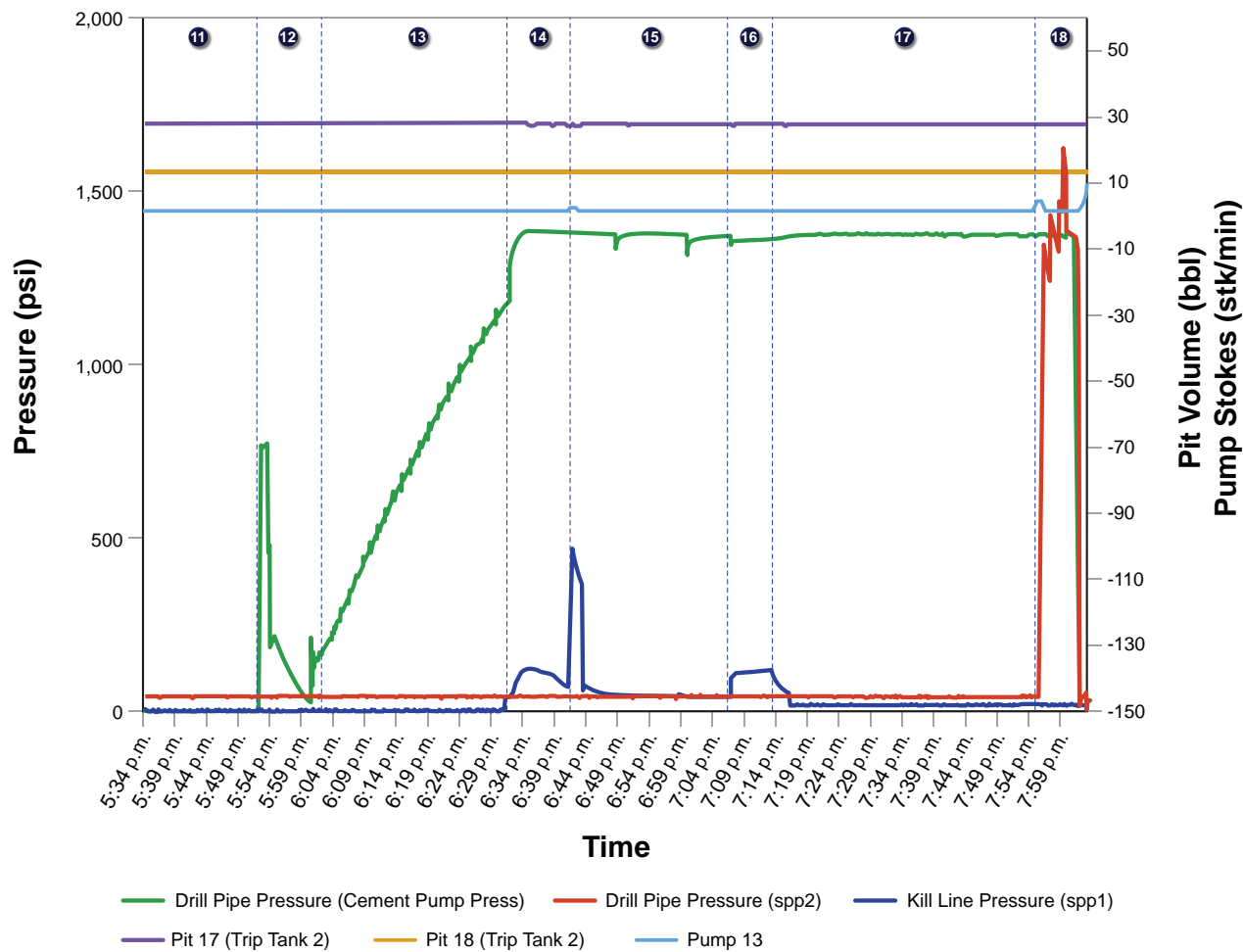
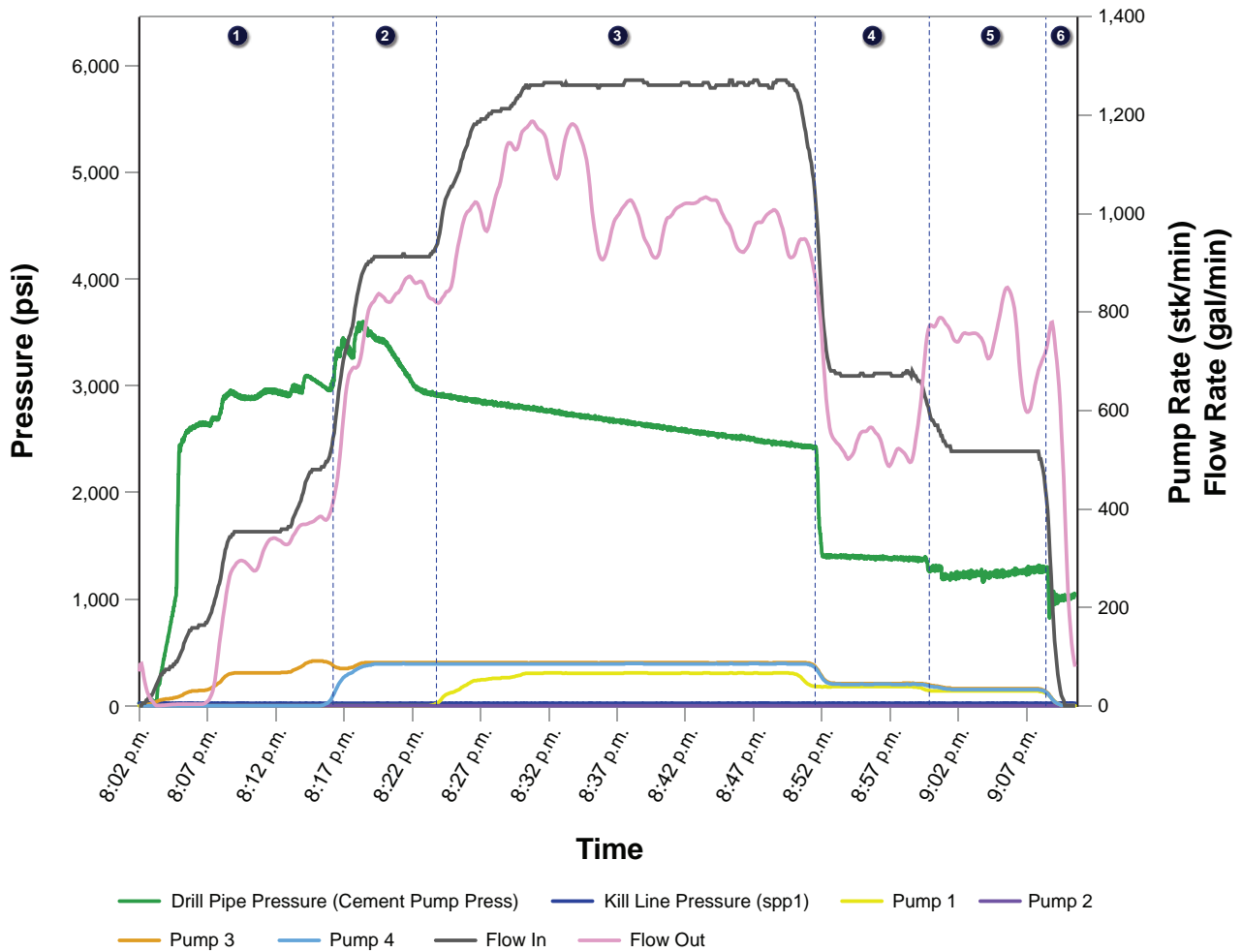

Figure 19 Build in Drill Pipe Pressure Following Initial Bleed



Event	Time	Description
11	5:34 p.m. - 5:51 p.m.	With the drill pipe pressure gauges (CPP, SPP2) isolated and the well underbalanced to the formation, pressure builds on the drill pipe with no corresponding increase on the drill pipe pressure gauges .
12	5:51 p.m. - 6:00 p.m.	A valve is opened exposing the drill pipe pressure gauge (CPP), located on the cement unit, to the pressure that had built on the drill pipe. After rapidly increasing to 770 psi, the pressure is again bled off.
13	6:00 p.m. - 6:31 p.m.	After bleeding pressure, the drill pipe is shut in and the drill pipe pressure (CPP) gradually increases to approximately 1,182 psi.
14	6:31 p.m. - 6:40 p.m.	The drill pipe pressure increases to approximately 1,182 psi. At approximately 6:31 p.m. a slight pressure increase is recorded on the the kill line, suggesting the subsea kill valve was opened. At 6:35 p.m. the drill pipe pressure increases to 1,400 psi and the kill line pressure increases to 137 psi, suggesting the well is in communication with the formation.
15	6:40 p.m. - 7:06 p.m.	Fluid is pumped into the kill line and the pressure (SPP1) increases to 492 psi, which suggests the kill line was full and that the subsea valve was closed. The kill line pressure (SPP1) is then bled off. A slight reduction in the drill pipe pressure (CPP) is noted on two occasions with no corresponding response on the kill line pressure (SPP1).
16	7:06 p.m. - 7:13 p.m.	The kill line pressure (SPP1) increases while drill pipe pressure (CPP) decreases suggesting the columns of fluid in drill pipe and kill line equalized.
17	7:13 p.m. - 7:54 p.m.	The kill line pressure is bled off and the negative test is conducted by monitoring the kill line for flow.

Figure 20 Overview of Events during the Negative Pressure Test from 5:34–8:02 p.m.



Final	Time	Description
1	8:02 p.m. - 8:16 p.m.	Pump 3 is turned on and pumps from the sea chest down the drill pipe. Shortly after the pump is turned on the lower annular is opened and the well once again becomes overbalanced to the formation.
2	8:16 p.m. - 8:23 p.m.	Pump 4 is turned on and Pumps 3 and 4 pump from the sea chest and down the drill pipe. The drill pipe pressure begins decreasing as seawater begins filling the annulus and 14 ppg mud exits the riser.
3	8:23 p.m. - 8:49 p.m.	Pump 1 is turned on and pumps seawater from the sea chest and down the boost line while Pumps 3, and 4 continue to pump down the drill pipe. The drill pipe pressure continues to decrease as seawater enters the annulus above the BOP and 14-ppg mud exits the riser. From approximately 8:27 p.m. - 8:36 p.m. approximately 43 bbl of fluid are pumped from the trip tank into diverter housing. It is estimated that the well becomes underbalanced sometime between 8:38 p.m. - 8:52 p.m.
4	8:49 p.m. - 8:59 p.m.	The pump rates are slowed in preparation of the spacer reaching the surface and the drill pipe pressure decreases accordingly. The pump rates establish a constant rate and the drill pipe pressure remains constant instead of decreasing.
5	8:59 p.m. - 9:07 p.m.	The pump rates are further reduced and the drill pipe pressure decreases accordingly. After establishing a constant pump rate the drill pipe pressure begins to increase. From approximately 8:58 p.m. - 9:06 p.m. the volume of fluid in the trip tank was again pumped into diverter housing.
6	9:07 p.m. - 9:09 p.m.	A determination is made that the spacer had reached the surface and pumps are shut down to perform a static sheen test.

Figure 21 Overview of Events during the Riser Displacement from 8:02–9:09 p.m.

After monitoring the well via the kill line for 30 minutes, no flow was detected.⁹⁶ The operator concluded that the negative pressure test was successful and directed the drill crew to proceed with final displacement.^{97, G} This required the operator to dismiss the anomalous 1,400-psi pressure reading on the drill pipe. A BP well site leader left the rig floor to report the negative pressure test results to BP's shore-based engineers.⁹⁸

Central to the misinterpretation of the negative pressure test was the operator's insistence on monitoring the kill line when conducting the test as opposed to the drill pipe.⁹⁹ Had the crew continued monitoring flow from the drill pipe, it is highly likely that those monitoring the well would have detected that it was in communication with the formations. When the operator changed to monitor the kill line, it was not recognized that the presence of spacer in the annulus below the BOP impacted the negative pressure test setup and precluded a valid negative pressure test.

BLADDER EFFECT

BP's investigation report asserts that the well site leader dismissed concerns about anomalous pressure readings on the drill pipe during the negative pressure test based on the Transocean drill crew's attribution of the anomalous pressure to the "bladder effect." Statements allege the Transocean drill crew used a so-called bladder effect in explaining the anomalous pressure readings on the drill pipe during the negative pressure test.

The Transocean investigation team found no evidence that the bladder effect is a phenomenon known to experts in the drilling industry. Furthermore, the investigation team did not identify any members of the crew of the *Deepwater Horizon* familiar with the term, including the colleagues and supervisors of the drill crew members who were killed in the incident and allegedly used the term. Nor did the investigation team encounter any *Deepwater Horizon* drill crew members who recall this term being used to explain the drill pipe pressure reading during the negative pressure test.

3.2.4 Final Displacement of Riser

Figure 21 is a summary of the events that occurred during the riser displacement from 8:02–9:09 p.m.¹⁰¹ Upon continuing with the displacement, at 8:02 p.m., pump 3 was turned on and the lower annular BOP element was opened to continue displacing the riser with seawater (*See Figure 21, Event 1*), in accordance with the displacement procedure.¹⁰² When the drill crew opened the annular BOP, the column of heavy fluid in the riser above the annular combined with the fluids in the well below the annular BOP to exert hydrostatic pressure against the formation pressure. The additional pressure made the well overbalanced to the formation and prevented flow of hydrocarbons into the well bore.¹⁰³

Pumps 3, 4, and 1 were utilized to displace the remaining mud in the riser.¹⁰⁴ *See Figure 21, Events 2 and 3.* The displaced fluids exiting the well were returned to the active pits (9 and 10), pit 7, and pit 6, respectively.¹⁰⁵ No fluids were transferred to the *Bankston* during the final displacement.¹⁰⁶

As lighter density seawater was pumped into the well, the heavier density drilling mud was displaced, which reduced the hydrostatic pressure being applied to the formation. From about 8:27–8:36 p.m., approximately 43 bbl of fluid were emptied from the trip tank into the diverter housing.¹⁰⁷ This temporarily increased the fluid volumes as measured by the flow sensor and also added to the total volume of fluids returning to the mud pits, complicating efforts to monitor flow returns. According to post-incident calculations, the well became underbalanced to one or more of the exposed formations sometime between 8:38 p.m. and 8:52 p.m. *See Figure 21, Event 3.* Without a functional cement barrier in the shoe track, a converted float collar, or a surface plug to stop them, hydrocarbons began to enter the well, but there was no clear indication of an influx at that time.¹⁰⁸

G Numerous independent experts have confirmed that the interpretation of the negative pressure test ultimately is the responsibility of the operator's personnel on the rig and onshore.¹⁰⁰

At approximately 8:49 p.m., the driller slowed the pump rates in anticipation of the spacer reaching the surface, based on the pump strokes outlined in the displacement procedure.¹⁰⁹ See Figure 21, Event 4. At approximately 8:58 p.m., fluid was again pumped from trip tank 2 (pit 17) into the diverter housing, and the pump rates were further reduced at 8:59 p.m.¹¹⁰ See Figure 21, Event 5. This additional fluid from the trip tank resulted in a temporary increase in the flow of fluids exiting the well. The pumps were shut down at 9:09 p.m. to conduct a static sheen test.¹¹¹ See Figure 21, Event 6. At this time, an estimated 61 bbl of formation fluids had flowed into the well.

Figure 24 is a summary of the events during the riser displacement from 9:09–9:31 p.m.¹¹³ The compliance engineer conducted the sheen test over a four-minute interval from 9:09–9:13 p.m. and, during this time, the drill pipe pressure increased from 1,013 psi to 1,202 psi.¹¹⁴ See Figure 24, Event 7. Although both the BP well site leader and the Sperry Sun mud logger have stated that they made visual flow checks during this period, both reported that the well was not flowing.¹¹⁵ However, the pressure increase was the result of hydrocarbons flowing into the well and pushing heavy mud upward in the well around the drill pipe.¹¹⁶ It is possible that fluids were directed overboard before these flow checks, as the flow path may have been modified as the pumps turned off.¹¹⁷ During drilling operations, the Sperry Sun flow sensor monitors the returns in conjunction with a camera in the gumbo box. During final displacement of the riser, once the well is cased, cemented, and tested, non-SOBM fluids may be discharged overboard rather than returned to the rig pits. On the *Deepwater Horizon*, the Sperry Sun flow sensor was placed behind the valve that is used to direct flow overboard. Therefore, overboard discharge bypassed the Sperry Sun sensor, the pits, and the camera located in the gumbo box.

Although the compliance engineer concluded that the sheen test was successful, and the BP well site leader accepted his conclusion, analysis of the data indicates that the spacer had not reached the surface.¹¹⁸ The primary indicator is the initial hydrostatic pressure of 1,013 psi, which was measured when the pumps were shut down at 9:09 p.m.¹¹⁹ See Figure 23a. Had the spacer arrived at the surface by this time, the actual pressure should have been closer to 500 psi.¹²⁰ See Figure 23b. Additionally, the measured fluid weight for the sheen test sample was 15.4 ppg, between the weight of the mud and spacer, indicating approximately 30% oil based mud in the sample. With this weight, the sample should not have passed a sheen test, and operations should have continued displacement to the mud pits.

Another indicator that the spacer had not arrived at the surface is the discrepancy between the total volume of fluid that had been pumped into the well and the volume of fluid returned to the pits.¹²¹ The M-I SWACO displacement procedure had specified that 1,237 bbl of fluid should be pumped to push the top of the spacer to the surface.¹²² Based on the cumulative pump strokes measured, the rig pumped the specified number of strokes in the procedure, plus what appears to be an additional 68 bbl to account for the mud that moved below the annular during the negative pressure test, for a total volume of 1,305 bbl.¹²³

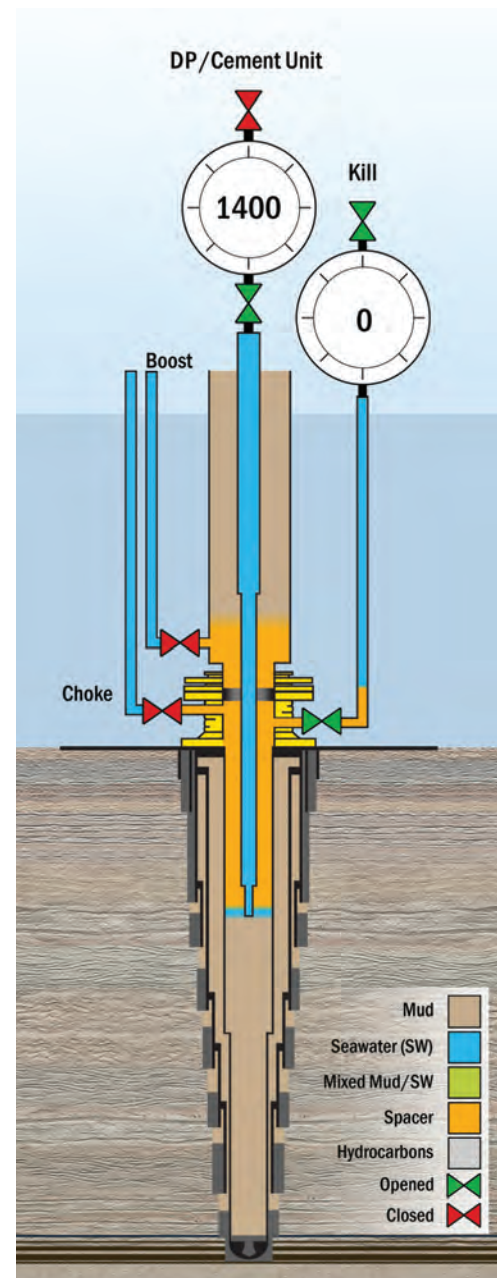

Figure 22 Drill Pipe Pressure at 1,400 psi during Negative Pressure Test

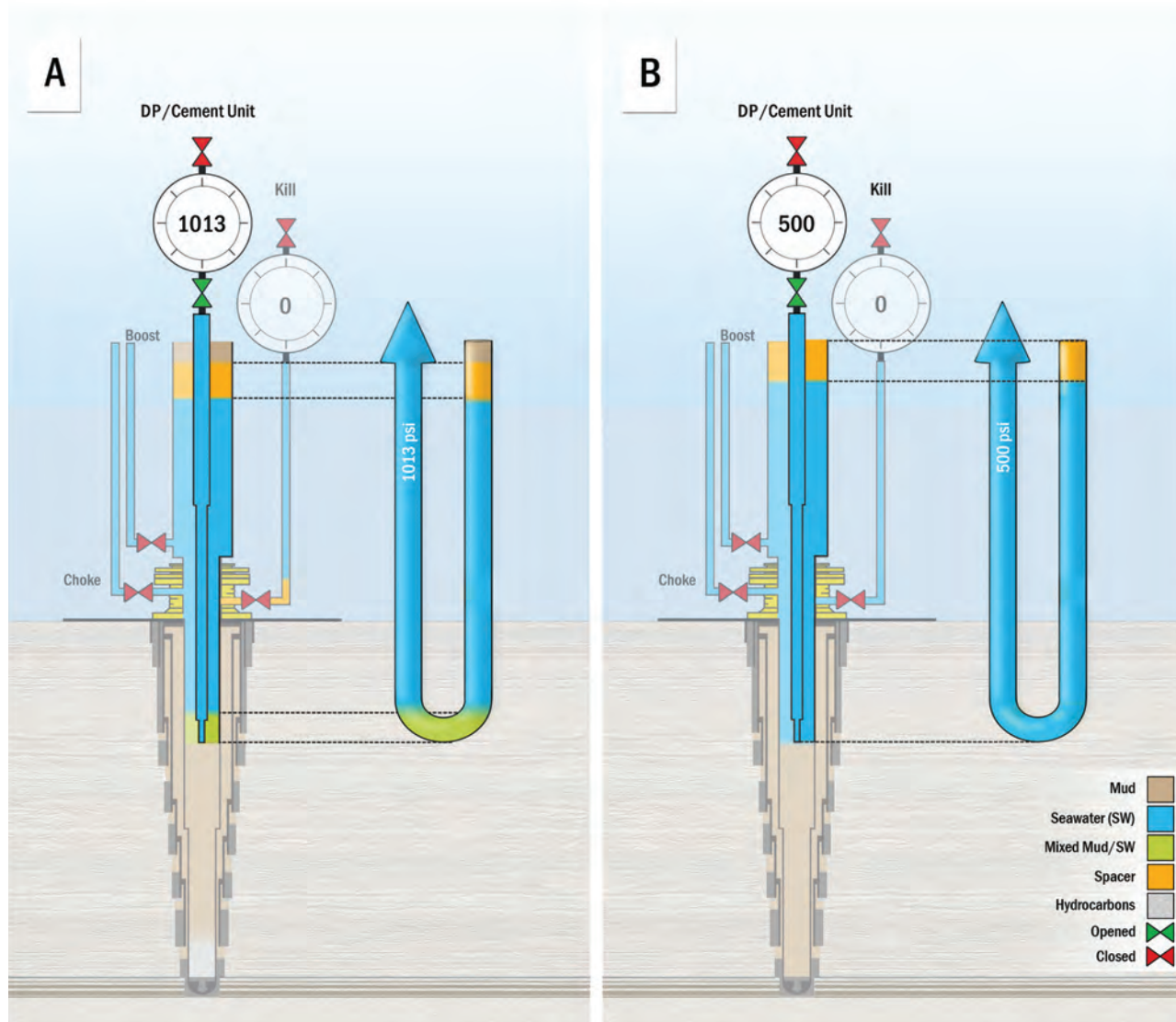
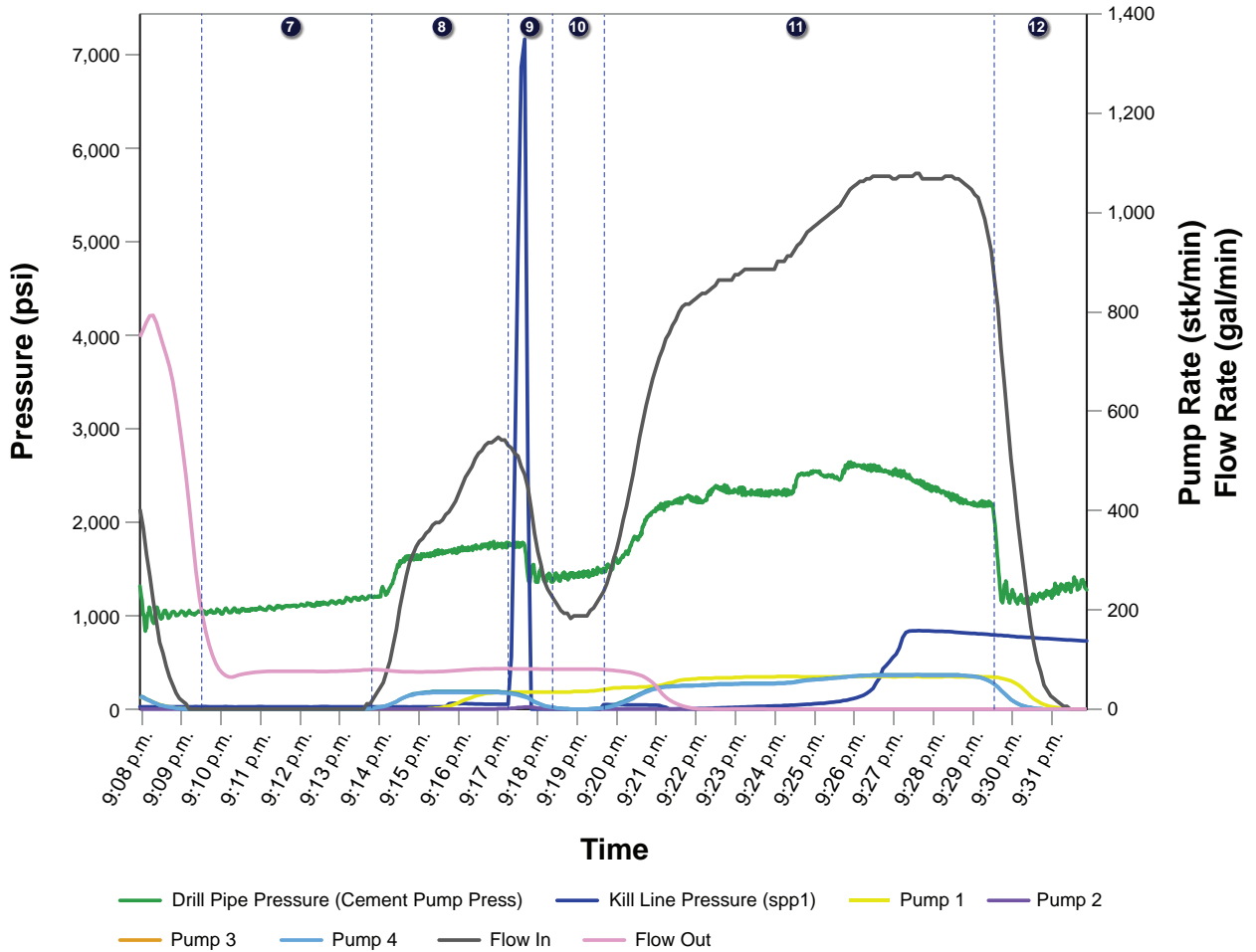

Figure 23 (a) Represents the actual pressure that was observed when the pumps were shut down to conduct the sheen test.
 (b) Represents the theoretical pressure that should have been observed had 16-ppg spacer been at the surface when the pumps were shut down to conduct the sheen test.

Post-event analysis of pit volume data also indicates that when the pumps were shut down at 9:09 p.m., only 1,203 bbl of fluid had been displaced from the well — 102 bbl less than was pumped.¹²⁴ Accounting for the initial underdisplacement and the 43 barrels of fluid that had been pumped from the trip tank into the flow line at 8:27 p.m. (See Figure 21, Event 3), the spacer may have been underdisplaced^H by as much as 215 bbl.¹²⁵ The additional heavy mud that remained in the riser above the column of spacer when the pumps were shut down resulted in the pressure reading of 1,013 psi instead of 500 psi, which would have been the reading if the spacer had been at the surface.¹²⁶ See Figure 23. The spacer not being at the surface was the result of the initial underdisplacement, lower-than-expected displacement volumes due to pump efficiencies, and potential losses to the formation.

^H This underdisplacement of the spacer is separate and apart from the initial underdisplacement referenced earlier in the sentence; it refers to the fact that it was not pumped to the surface as intended.



Event	Time	Description
7	9:09 p.m. - 9:13 p.m.	After the pumps are shut down and while the sheen test was being performed, the drill pipe pressure increased from 1,013 psi - 1,202 psi.
8	9:13 p.m. - 9:17 p.m.	Pumps 3, 4 and then 1 are turned on to continue the displacement with the return flow diverted overboard.
9	9:17 p.m. - 9:18 p.m.	Pump 2 is turned on and lined up to pump down the choke/kill line. The kill line pressure quickly increases to 7,126 psi and the pressure relief valve opens. Pumps 2, 3, and 4 are shut down while pump 1 continues pumping.
10	9:18 p.m. - 9:19 p.m.	The drill pipe pressure slowly increases while pumps 3 and 4 remained shut down. Pump 1 continues pumping at a constant rate down the boost line (no Sperry Sun pressure data available for the boost pump).
11	9:19 p.m. - 9:29 p.m.	Pumps 3 and 4 are turned on to continue the displacement. The kill line pressure begins a gradual increase to 833 psi before declining at a constant rate.
12	9:29 p.m. - 9:31 p.m.	Pumps 1, 3 and 4 are turned off to diagnose anomalous pressure readings. The drill pipe pressure begins to increase.

Figure 24 Overview of Events during the Riser Displacement from 9:09–9:31 p.m.

The BP well site leader directed the drill crew to continue with the displacement, and pumping resumed at 9:13 p.m.¹²⁷ Pumps 3, 4, and 1 were turned on, with the returns being pumped overboard.¹²⁸ See Figure 24, Event 8. At 9:17 p.m., pump No. 2 was brought online, and the kill line pressure rapidly increased to 7,126 psi.¹²⁹ See Figure 24, Event 9. At this time, pump 2 was lined up to pump down the choke and kill lines but was turned on prior to opening the kill line valve.¹³⁰ Pumping against the closed valve caused the pressure to build and the pressure relief valve to open.¹³¹ While pump 1 continued to pump down the boost line, pumps 2, 3, and 4 were shut down to assess the situation and to identify the affected pump. During this time, the drill pipe pressure

slowly increased.¹³² See Figure 24, Events 9 and 10. After determining that the pressure relief valve on pump No. 2 had released, the crew brought pumps 3 and 4 back online to continue the riser displacement, which created an expected increase in drill pipe pressure readings.¹³³ See Figure 24, Event 11.

Between 9:22 p.m. and 9:27 p.m., a gradual and unusual increase in the kill line pressure occurred.¹³⁴ See Figure 24 Event 11. The pressure slowly increased to 833 psi and then decreased at a constant rate.¹³⁵ Kill line pressure is not unusual; however, in this instance, the gradual build in pressure suggests that the kill line may have been plugged or that a valve was partially opened. At 9:30 p.m., the drill crew, recognized an anomaly in the pressure readings and shut down the pumps to investigate.¹³⁶ See Figure 24, Event 12 and Figure 25.

3.2.5 Overview of Events Occurring during Riser Evacuation (9:31–9:49 p.m.)

Hydrocarbons continued to flow into the well after the pumps stopped, pushing heavy fluid into the annulus above the end of the drill string and causing increased drill pipe pressure.¹³⁷ See Figure 26, Event 13. At about 9:34 p.m., the drill pipe pressure stabilized as heavy fluid was pushed into the riser.¹³⁸ See Figure 26, Event 14.

At approximately 9:36 p.m., the driller directed a floor hand to bleed pressure from the drill pipe until it equalized with the kill line.¹³⁹ This was done for a minute-and-a-half and is indicative of the drill crew diagnosing a plugged line or valve in the system. When the bleed stopped, pressure returned, but to a lower level than previously.¹⁴⁰ See Figure 26, Event 15. At 9:39 p.m., while the drill crew was diagnosing the anomaly, post-incident analysis revealed that the influx of hydrocarbons reached the end of the drill string at a depth of 8,367 ft. and began to fill the annulus.¹⁴¹ See Figure 27. This influx resulted in a rapid decline in drill pipe pressure and triggered the typical pressure signal of a kick.¹⁴²

By 9:42 p.m., post-incident analysis indicates that hydrocarbons reached the top of the casing and began to flow into the riser.¹⁴³ At that time, the drill crew was changing the flow path to the trip tank to check for flow.¹⁴⁴ See Figure 28. The rapid increase in volume in the trip tank alerted the drill crew to an influx.¹⁴⁵ See Figure 26, Event 17.

The drill crew activated the upper annular BOP element at 9:43 p.m.¹⁴⁶ See Figure 26, Event 18. At that time, the well was flowing at an estimated 92 bbl per minute at the surface.¹⁴⁷ An increase in kill line pressure at this time indicates that the annular did close.¹⁴⁸ The subsequent decline in pressure indicates, however, that the annular did not hold a seal.¹⁴⁹ See Chapter 3.4, for a detailed discussion of the BOP.

Post incident analysis confirms that the flow of hydrocarbons accelerated and reached the rig floor between 9:43 p.m. and 9:45 p.m.¹⁵⁰ The drill crew activated the diverter to direct fluid to the mud-gas separator (MGS), and called the BP well site leader,¹⁵¹ the senior toolpusher, and the bridge¹⁵² to alert them that a well-control event was occurring. See Figure 26, Event 18.

Initially, the crew stopped the flow on the rig floor by diverting to the MGS.¹⁵³ However, the volume and force of the flow overwhelmed the MGS, and fluid began pouring out of its outlet lines.¹⁵⁴ See Figure 26, Event 19.

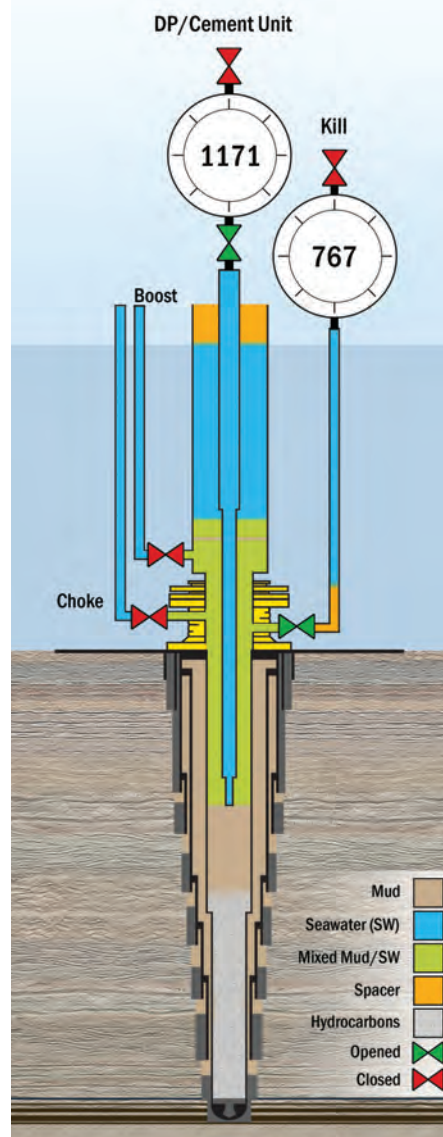
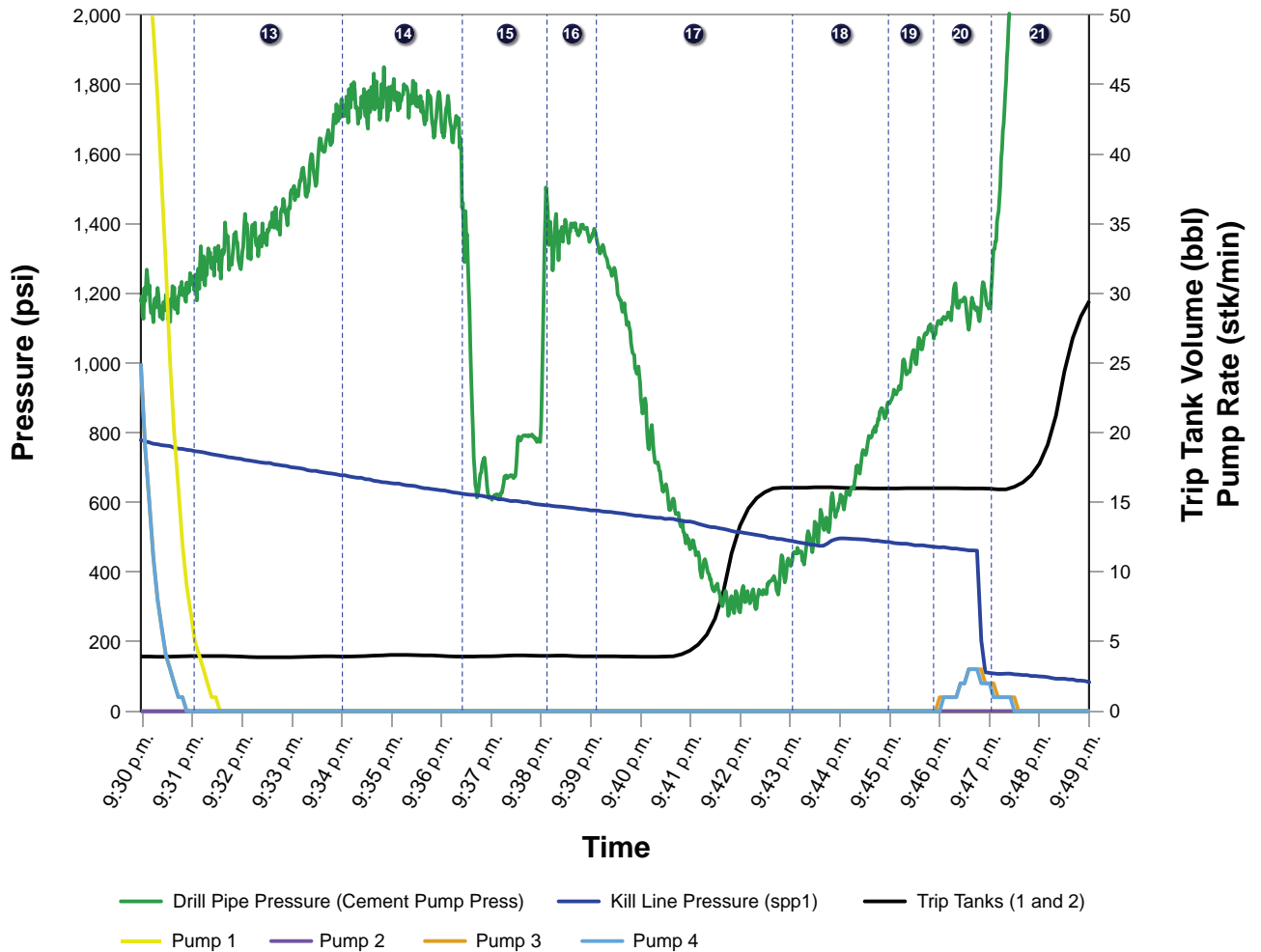

Figure 25 Pressure Anomaly Identified and Pumps Shut Down



Event	Time	Description
13	9:31 p.m. - 9:34 p.m.	With the pumps shut down, the drill pipe pressure increases from 1,227 psi - 1,721 psi and the kill line pressure decreases at a constant rate.
14	9:34 p.m. - 9:36 p.m.	The drill pipe pressure stabilizes and the kill line pressure continues to decrease at a constant rate.
15	9:36 p.m. - 9:38 p.m.	The drill crew opens the drill pipe and bleeds the drill pipe pressure. The drill pipe is shut-in and the drill pipe pressure returned, but increased to a lower pressure than before.
16	9:38 p.m. - 9:39 p.m.	The drill pipe pressure stabilizes and remains relatively constant while the kill line pressure continues to decline.
17	9:39 p.m. - 9:43 p.m.	The influx of hydrocarbons reach the end of the drill string and begin to rapidly fill the annulus causing the drill pipe pressure to decrease. At about the same time that hydrocarbons reach the top of the casing and begin to flow into the riser, the trip tank is lined up and flow from the well causes the volume to increase rapidly.
18	9:43 p.m. - 9:45 p.m.	The annular is closed but does not seal. The gas in the riser continues to expand pushing mud onto the rig floor and the flow is diverted to the mud-gas-separator (MGS).
19	9:45 p.m. - 9:46 p.m.	The flow exceeds the capacity of the MGS and mud begins to flow out of the MGS outlet lines.
20	9:46 p.m. - 9:47 p.m.	The gas reaches the surface and begins to flow through the MGS onto the rig. One or more of the variable bore rams (VBR) are activated.
21	9:47 p.m. - 9:49 p.m.	One or more of the VBR's are sealed and well is temporarily shut-in.

Figure 26 Overview of Events during the Riser Displacement from 9:31–9:49 p.m.

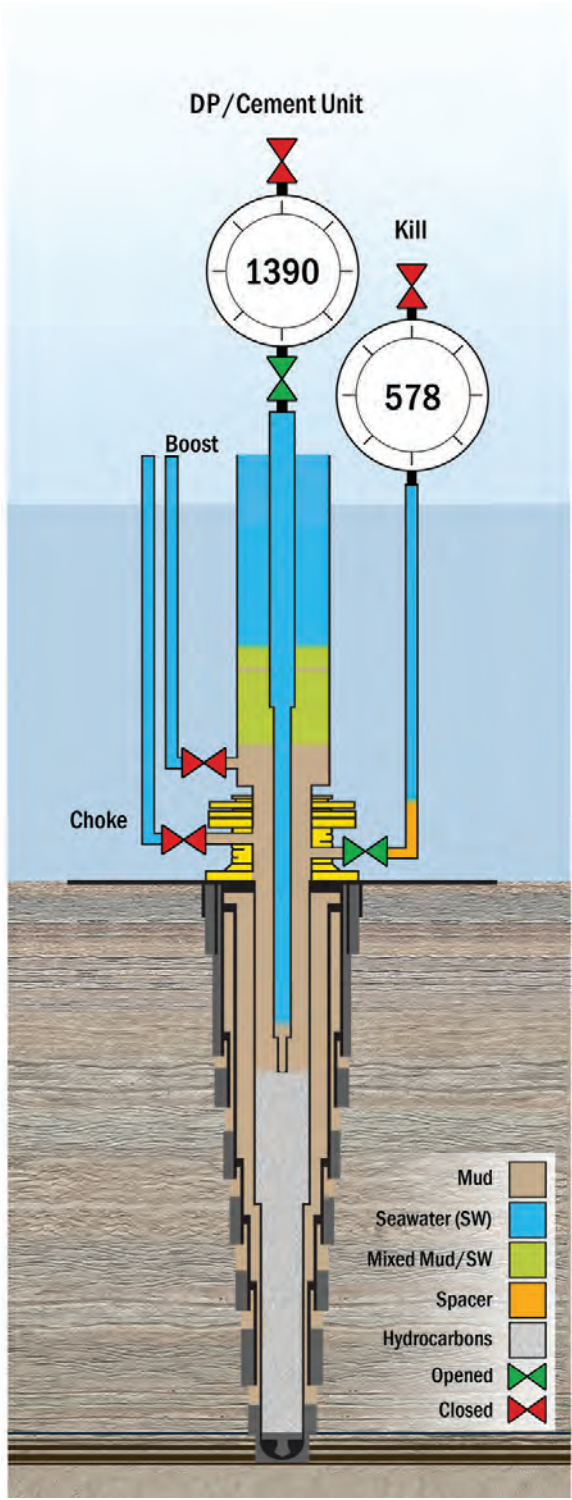

Figure 27 Hydrocarbons Reach End of Drill String

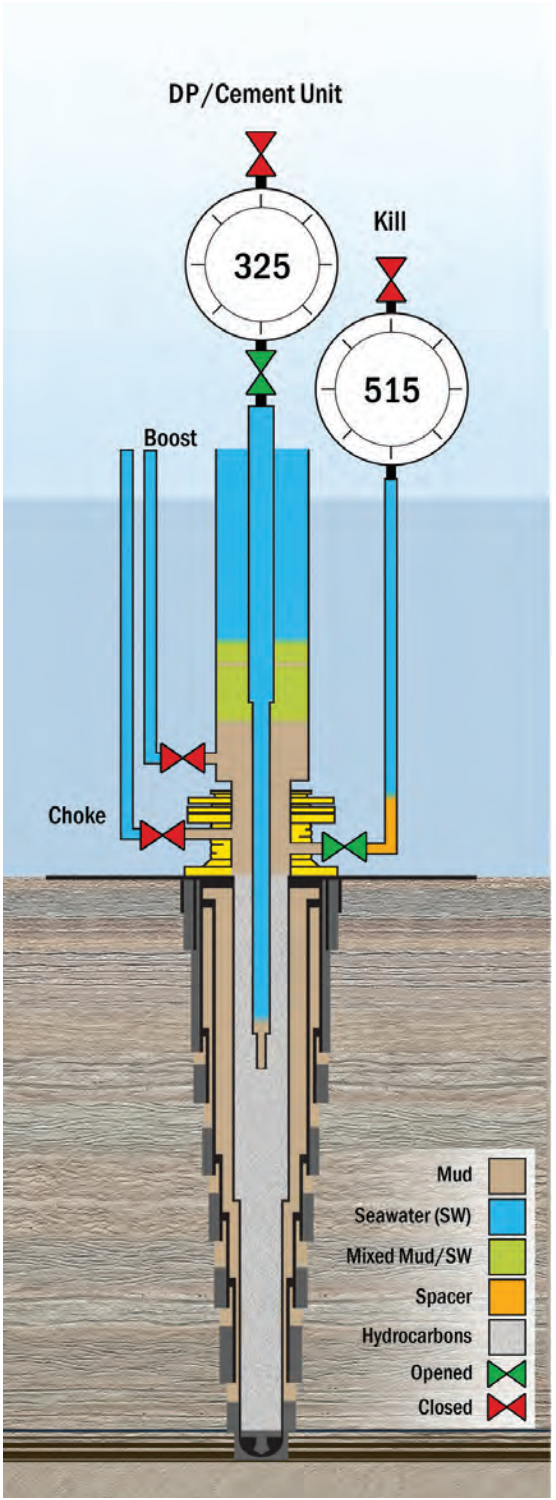

Figure 28 Hydrocarbons Reach Top of Casing

Between 9:46 p.m. and 9:47 p.m., the crew activated one or more of the BOP variable bore rams (VBRs) to seal the annular space.¹⁵⁵ See Figure 26, Event 20. At 9:47 p.m., the drill pipe pressure increased and the kill line pressure decreased,¹⁵⁶ indicating that a ram had successfully closed and sealed the annular space.¹⁵⁷ See Figure 26, Event 21. At approximately 9:49 p.m., the real-time Sperry Sun data feed to shore ended.¹⁵⁸ It is assumed that the rig lost power at this time.

3.2.6 Temporary Abandonment Findings of Fact

- *Temporary Abandonment Plan:* BP generated at least five different temporary abandonment plans for the Macondo well between April 12 and April 20, 2010. The temporary abandonment plan used on April 20 increased the risk of a well-control event occurring by directing the drill crew to displace drilling mud with seawater, removing the primary well-control barrier prior to installation of a secondary cement barrier or negative pressure test of the existing barrier. A number of decisions and changes resulted in a final temporary abandonment plan that added unnecessary risk and was not approved by MMS. The investigation team found no evidence that these risks were communicated to the drill crew, subjected to a formal risk assessment, or resulted in Management of Change documents.
- *Initial Displacement:* The initial displacement was planned incorrectly, and the execution did not meet the objective. The final temporary abandonment plan required a partial displacement that relied on displacing the casing annulus below the annular BOP with seawater to achieve the desired negative pressure test conditions. However, this objective was not achieved due to calculation errors in the final displacement procedure, lower pump efficiencies likely caused by the spacer materials, potential downhole losses, and spacer moving below the closed annular. These factors resulted in a large volume of spacer in the annulus during the negative pressure test that went unidentified due to inadequate fluid volume tracking and lack of procedures that indicated the appropriate pressure readings for a satisfactory initial test configuration. With spacer in the annulus below the closed annular BOP, a valid negative pressure test could not be achieved by monitoring the kill line.
- *Negative Pressure Test:* Despite the 1,400 psi of pressure observed on the drill pipe during the negative pressure test, no flow was observed from the kill line, and the test was interpreted incorrectly as being successful. Pressures observed during the negative pressure test confirm that the cement barrier had failed, pressure was being transmitted past the float equipment, and the well was in communication with the formation.

The spacer that remained in the annulus below the closed annular BOP likely contributed to the misinterpretation of the test. Also central to the misinterpretation was BP's insistence on monitoring the kill line as opposed to the drill pipe. Had the operator continued monitoring the drill pipe, and assuming well conditions were consistent with those encountered while monitoring the kill line, it is highly likely that those monitoring the well would have detected that it was in communication with the formation. None of the individuals monitoring the well, including the Transocean drill crew, recognized that the negative pressure test had failed. The operator concluded that the negative pressure test was successful and decided to proceed with the final displacement.

- *Final Riser Displacement:* Hydrocarbons began to flow into the well sometime between 8:38 p.m. and 8:52 p.m., when the well became underbalanced during the riser displacement. The failure of the cement barrier and the absence of a secondary cement barrier (e.g. surface plug or bridge plug) inside the casing allowed hydrocarbons to enter the well. At that time, however, between 8:38 p.m. and 8:52 p.m., there was no clear indication of an influx. Post incident analysis of the available data identified several indications of an influx during final displacement. Given the loss of the members of the drill crew, the rig, and the rig monitoring systems, it is not known which information the drill crew was monitoring, nor is it known why the drill crew did not detect an anomaly until approximately 9:30 p.m. At that time, the drill crew took actions to evaluate the anomaly, and upon confirming an influx at 9:42 p.m., undertook well-control activities, including the activation of various elements of the BOP.

Post-incident analysis indicated emptying of the trip tank into the flow line during the displacement masked an influx into the wellbore.

Two individuals indicated the well was not flowing at the time mud pumps were shut down for the sheen test. This may have been due to a change in flow path overboard just prior to the visual confirmations. Post-incident data analysis shows the well was underbalanced and flowing at this point in time.

1. Application for Permit to Modify, April 16, 2010, BP-HZN-MBI00023711, 13; Daily Drilling Report, April 20, 2010, TRN-MDL-00011518.
2. Testimony of Steve Lewis, National Oil Spill Commission Meeting Nov. 9, 2010, 144:10-12; Testimony of John Smith, National Oil Spill Commission Meeting Nov. 9, 2010, 144:15-17; Testimony of Darryl Bourgoyne, National Oil Spill Commission Meeting Nov. 9, 2010, 144:20-22, 145:1-8.
3. 30 C.F.R. § 250.1721 (2009); 30 C.F.R. § 250.1712 (2009); Application for Permit to Modify, April 16, 2010, BP-HZN-MBI00023711, 13.
4. GoM Exploration Wells TA Plugs and Riser Cleaning, April 12, 2010, BP-HZN-CEC021260, 69; Brian Morel, e-mail to Ronald Sepulvado, April 14, 2010, BP-HZN-MBI00126982; GoM Exploration Wells Surface and Cement Plug, April 15, 2010, BP-HZN-CEC017621, 28; Application for Permit to Modify, April 16, 2010, BP-HZN-MBI00023711, 13; Brian Morel, e-mail to Don Vidrine, Robert Kaluza et al., April 20, 2010, BP-HZN-CEC020165.
5. GoM Exploration Wells TA Plugs and Riser Cleaning, April 12, 2010, BP-HZN-CEC021260, 69.
6. Brian Morel, e-mail to Ronald Sepulvado, April 14, 2010, BP-HZN-MBI00126982.
7. 30 C.F.R. § 250.1721(d) (2009); Testimony of Leo Lindner, USCG/BOEM Marine Board of Investigation, July 19, 2010, 272:5-11.
8. GoM Exploration Wells Surface and Cement Plug, April 15, 2010, BP-HZN-CEC017621, 28.
9. Mark Hafle, e-mail to Brian Morel, April 16, 2010, BP-HZN-00127489.
10. Brian Morel, e-mail to Ronald Sepulvado, April 14, 2010, BP-HZN-MBI00126982; GoM Exploration Wells 7" x 9-7/8" Interval Report, April 15, 2010, BP-HZN-CEC017621, 28.
11. Mark Hafle, e-mail to Brian Morel, April 16, 2010, BP-HZN-00127489.
12. Application for Permit to Modify, April 16, 2010, BP-HZN-MBI00023711, 13.
13. CFR § 250.1721(d) (2009); Application for Permit to Modify, April 16, 2010, BP-HZN-MBI00023711, 13.
14. 30 C.F.R. § 250.1715(b)(1) (2009); Application for Permit to Modify, April 16, 2010, BP-HZN-MBI00023711, 13. (Top of cement was planned at 3,000 ft. below the mud line.)
15. *Ibid.*
16. Application for Permit to Modify, April 16, 2010, BP-HZN-MBI00023711, 13.
17. Brian Morel, e-mail to Don Vidrine, Robert Kaluza et al., April 20, 2010, BP-HZN-CEC020165.
18. Engineer's Handwritten Tally Book, BP-HZN-MBI00139592; Testimony of Micah Burgess, USCG/BOEM Marine Board of Investigation, May 29, 2010, 111:7-15; Transocean Investigation Team Interview of Brandon Burgess, June 29, 2010; Transocean, Daily Drilling Report, April 20, 2010, TRN-MDL-00011518.
19. Daily Drilling Report, April 20, 2010, TRN-MDL-00011518.
20. *Ibid.*
21. See Appendix G, 75; Daily Drilling Report, April 20, 2010, TRN-MDL-00011518; Sperry Drilling Services data logs (cement unit data), April 18-20, 2010.
22. See Appendix G, 74-75.
23. Daily Drilling Report, April 20, 2010, TRN-MDL-00011518.
24. Clean Water Act, 33 U.S.C. § 1251, et. seq.
25. *Damon Bankston* Log, April 20, 2010, TDW0020, 21; Rheliant Displacement Procedure, BP-HZN-MBI00170827; Sperry Drilling Services data logs (mud pit data), April 19-20, 2010, BP-TO11000827.
26. Sperry Drilling Services data logs (mud pit data), April 19, 2010-April 20, 2010, BP-TO11000827; *Damon Bankston* Log, April 20, 2010, TDW0020, 21.
27. *Ibid.*

28. Rheliant Displacement Procedure, BP-HZN-MBI00170827; Testimony of Leo Lindner, USCG/BOEM Marine Board of Investigation, July 19, 2010, 272:11–13.
29. James Hogan e-mail to Leo Linder, April 20, 2010, BP-HZN-MBI00129040.
30. *Ibid.*
31. Rheliant Displacement Procedure, BP-HZN-MBI00170827; Testimony of Leo Lindner, USCG/BOEM Marine Board of Investigation, July 19, 2010, 275:21–23.
32. Rheliant Displacement Procedure, BP-HZN-MBI00170827; Sperry Drilling Services data logs (drilling parameters), April 5–20, 2010; Sperry Drilling Services data logs (drilling parameters with cement unit data), April 15–20, 2010.
33. Sperry Drilling Services data logs (mud pit data), April 18–19, 2010, BP-TO11000827; Sperry Drilling Services data logs (drilling parameters), April 5–20, 2010; Sperry Drilling Services data logs (drilling parameters with cement unit data), April 15–20, 2010.
34. Sperry Drilling Services data logs (drilling parameters), April 5–20, 2010; Sperry Drilling Services data logs (drilling parameters with cement unit data), April 15–20, 2010.
35. Rheliant Displacement Procedure, BP-HZN-MBI00170827.
36. See Appendix G, 27, 63, 157–159.
37. Sperry Drilling Services data logs (drilling parameters with cement unit data), April 15–20, 2010; Sperry Drilling Services data logs (drilling parameters), April 5–20, 2010.
38. See Appendix G, 63.
39. See Appendix G, 63; Rheliant Displacement Procedure, BP-HZN-MBI00170827.
40. See Appendix G, 62; Rheliant Displacement Procedure, BP-HZN-MBI00170827.
41. See Appendix G, 159; Rheliant Displacement Procedure, BP-HZN-MBI00170827.
42. See Chapter 3.1.
43. See Appendix G, 56–57.
44. BP, PLC. *Deepwater Horizon* Investigation Report, September 8, 2010 Appendix Q.
45. See Appendix G, 54–66.
46. See Appendix G, 73–75.
47. *Ibid.*
48. See Appendix G, 26–34.
49. See Appendix G, 63.
50. See Appendix G, 63, 73–76.
51. Rheliant Displacement Procedure, BP-HZN-MBI00170827; National Oil Spill Commission Meeting, Nov. 9, 2010, 145–148.
52. Application for Permit to Modify, April 16, 2010, BP-HZN-MBI00023711, 13; Brian Morel, e-mail to Don Vidrine, Robert Kaluza et al., April 20, 2010, BP-HZN-CEC020165.
53. Sperry Drilling Services data logs (mud pit data), April 19, 2010–April 20, 2010, BP-TO11000827; Sperry Drilling Services data logs (cement unit data), April 18–20, 2010; Sperry Drilling Services data logs (drilling parameters), April 5–20, 2010.
54. See Appendix G, 77; Sperry Sun Drilling Services data logs (mud pit data), April 19–20, 2010, BP-TO11000827; Sperry Drilling Services data logs (cement unit data), April 18–20, 2010; Sperry Drilling Services data logs (drilling parameters), April 5–20, 2010.
55. Transocean Investigation Team Interview of Mark Hay, May 18, 2010.
56. Testimony of Mark Hay, USCG/BOEM Marine Board of Investigation, August 25, 2010, 234:18–25.
57. Sperry Drilling Services data logs (mud pit data), April 19, 2010–April 20, 2010, BP-TO11000827; Sperry Drilling Services data logs (cement unit data), April 18–20, 2010; Sperry Drilling Services data logs (drilling parameters), April 5–20, 2010.

58. See Appendix G, 77; Sperry Drilling Services data logs (mud pit data), April 19, 2010–April 20, 2010, BP-TO11000827; Sperry Drilling Services data logs (cement unit data), April 18–20, 2010; Sperry Drilling Services data logs (drilling parameters), April 5–20, 2010.
59. Sperry Drilling Services data logs (mud pit data), April 19-20, 2010; Sperry Drilling Services data logs (cement unit data), April 18-20, 2010; Sperry Drilling Services data logs (drilling parameters), April 15-20, 2010.
60. Sperry Drilling Services data logs (mud pit data), April 19, 2010–April 20, 2010, BP-TO11000827.
61. Sperry Drilling Services data logs (mud pit data), April 19, 2010–April 20, 2010, BP-TO11000827; Sperry Drilling Services data logs (cement unit data), April 18–20, 2010; Sperry Drilling Services data logs (drilling parameters), April 5–20, 2010.
62. See Appendix G, 79–80.
63. Sperry Drilling Services data logs (mud pit data), April 19, 2010–April 20, 2010, BP-TO11000827; Sperry Drilling Services data logs (cement unit data), April 18–20, 2010; Sperry Drilling Services data logs (drilling parameters), April 5–20, 2010.
64. *Ibid.*
65. *Ibid.*
66. Transocean Investigation Team Interview of Mark Hay, May 18, 2010; Sperry Drilling Services data logs (mud pit data), April 19, 2010–April 20, 2010, BP-TO11000827; Sperry Drilling Services data logs (cement unit data), April 18–20, 2010; Sperry Drilling Services data logs (drilling parameters), April 5–20, 2010.
67. See Appendix G, 79; Sperry Sun Drilling Services data logs (mud pit data), April 19-20, 2010, BP-TO11000827; Sperry Drilling Services data logs (cement unit data), April 18-20, 2010; Sperry Drilling Services data logs (drilling parameters), April 5-20, 2010.
68. See Appendix G, 80, 183.
69. BP Investigation Team Interview of Robert Kaluza, April 28, 2010, BP-HZN-CEC020165,187–188, 204.
70. BP Investigation Team Interview of Robert Kaluza, April 28, 2010, BP-HZN-CEC020165, 201, 204.
71. *Ibid.*
72. BP Investigation Team Interview of Robert Kaluza, April 28, 2010, BP-HZN-CEC020165, 188, 201; Sperry Drilling Services data logs (mud pit data), April 19, 2010–April 20, 2010, BP-TO11000827; Sperry Drilling Services data logs (cement unit data), April 18–20, 2010; Sperry Drilling Services data logs (drilling parameters), April 5–20, 2010.
73. Investigation Team Interview of Robert Kaluza, April 28, 2010, BP-HZN-CEC020165, 201, 204; Application for Permit to Modify, April 16, 2010, BP-HZN-MBI00023711, 13.
74. See Appendix G, 81; BP Investigation Team Interview of Robert Kaluza, April 28, 2010, BP-HZN-CEC020165, 204; BP Investigation Team Interview of Vince Tabler, April 5, 2010, BP-HZN-MBI0129623; Sperry Drilling Services data logs (mud pit data), April 19, 2010–April 20, 2010, BP-TO11000827; Sperry Drilling Services data logs (cement unit data), April 18–20, 2010; Sperry Drilling Services data logs (drilling parameters), April 5–20, 2010.
75. BP Investigation Team Interview of Robert Kaluza, April 28, 2010, BP-HZN-CEC020165, 204; BP Investigation Team Interview of Vince Tabler, April 5, 2010, BP-HZN-MBI0129623.
76. BP Investigation Team Interview of Robert Kaluza, April 28, 2010, BP-HZN-CEC020165, 204.
77. Sperry Drilling Services data logs (drilling parameters with cement unit data), April 15–20, 2010; Sperry Drilling Services data logs (mud pit data), April 19, 2010–April 20, 2010, BP-TO11000827; Sperry Drilling Services data logs (cement unit data), April 18–20, 2010; Sperry Drilling Services data logs (drilling parameters), April 5–20, 2010.
78. *Ibid.*
79. *Ibid.*
80. *Ibid.*
81. *Ibid.*
82. See Appendix G, 89; Sperry Drilling Services data logs (drilling parameters with cement unit data), April 15–20, 2010; Sperry Drilling Services data logs (mud pit data), April 19, 2010–April 20, 2010, BP-TO11000827; Sperry Drilling Services data logs (cement unit data), April 18–20, 2010; Sperry Drilling Services data logs (drilling parameters), April 5–20, 2010.

83. *Ibid.*
84. See Appendix G, 85–87; Sperry Drilling Services data logs (drilling parameters with cement unit data), April 15–20, 2010; Sperry Drilling Services data logs (mud pit data), April 19, 2010–April 20, 2010, BP-TO11000827; Sperry Drilling Services data logs (cement unit data), April 18–20, 2010; Sperry Drilling Services data logs (drilling parameters), April 5–20, 2010.
85. BP Investigation Team Interview of Robert Kaluza, April 28, 2010, BP-HZN-CEC020165, 77; BP Investigation Team Interview of Don Vidrine, BP-HZN-MBI00021406, 18.
86. *Ibid.*
87. See Appendix G, 88; BP Investigation Team Interview of Don Vidrine, BP-HZN-MBI00021406, 14; Sperry Drilling Services data logs (drilling parameters with cement unit data), April 15–20, 2010; Sperry Drilling Services data logs (mud pit data), April 19, 2010–April 20, 2010, BP-TO11000827; Sperry Drilling Services data logs (cement unit data), April 18–20, 2010; Sperry Drilling Services data logs (drilling parameters), April 5–20, 2010.
88. BP Investigation Team Interview of Don Vidrine, BP-HZN-MBI00021406, 19; Testimony of Christopher Pleasant, Hearing before the *Deepwater Horizon* Joint Investigation Team, May 28, 2010, 117:16-25, 118:1-2; BP Investigation Team Interview of Robert Kaluza, April 28, 2010, BP-HZN-CEC020165, 77.
89. BP Investigation Team Interview of Don Vidrine, BP-HZN-MBI00021406, 19; Testimony of Christopher Pleasant, Hearing before the *Deepwater Horizon* Joint Investigation Team, May 28, 2010, 118:3-6.
90. *Ibid.*
91. Testimony of Christopher Pleasant, Hearing before the *Deepwater Horizon* Joint Investigation Team, May 28, 2010, 118:10–13.
92. Investigation Team Interview of Don Vidrine, April 27, 2010, BP-HZN-MBI00021406; BP Investigation Team Interview of Robert Kaluza, April 28, 2010, BP-HZN-CEC020165, 77; Sperry Drilling Services data logs (drilling parameters with cement unit data), April 15–20, 2010; Sperry Drilling Services data logs (mud pit data), April 19, 2010–April 20, 2010, BP-TO11000827; Sperry Drilling Services data logs (cement unit data), April 18–20, 2010; Sperry Drilling Services data logs (drilling parameters), April 5–20, 2010.
93. See Appendix G, 89.
94. *Ibid.*
95. *Ibid.* See Appendix G.
96. Investigation Team Interview of Don Vidrine, April 27, 2010, BP-HZN-MBI00021406, 19.
97. Investigation Team Interview of Don Vidrine, April 27, 2010, BP-HZN-MBI00021406, 14.
98. Testimony of Christopher Pleasant, Hearing before the *Deepwater Horizon* Joint Investigation Team, May 28, 2010, 118:16–18.
99. Testimony of Christopher Pleasant, Hearing before the *Deepwater Horizon* Joint Investigation Team, May 28, 2010, 117:21–24.
100. Testimony of Mark Bly, National Oil Spill Commission Meeting November 8, 2010, 284:7–19.
101. Sperry Drilling Services data logs (drilling parameters with cement unit data), April 15–20, 2010; Sperry Drilling Services data logs (cement unit data), April 18–20, 2010; Sperry Drilling Services data logs (drilling parameters), April 5–20, 2010.
102. Rheliant Displacement Procedure, BP-HZN-MBI00170827; Sperry Drilling Services data logs (drilling parameters with cement unit data), April 15–20, 2010; Sperry Drilling Services data logs (cement unit data), April 18–20, 2010; Sperry Drilling Services data logs (drilling parameters), April 5–20, 2010.
103. See Appendix G, 91.
104. Sperry Drilling Services data logs (drilling parameters with cement unit data), April 15–20, 2010; Sperry Drilling Services data logs (cement unit data), April 18–20, 2010; Sperry Drilling Services data logs (drilling parameters), April 5–20, 2010.
105. See Appendix G, 93–94; Sperry Drilling Services data logs (mud pit data), April 19, 2010–April 20, 2010, BP-TO11000827.
106. *Damon Bankston* Log, April 20, 2010, TDW0020, 21.
107. See Appendix G, 93–94.

108. See Appendix G, 98–99; Sperry Drilling Services data logs (drilling parameters with cement unit data), April 15–20, 2010; Sperry Drilling Services data logs (cement unit data), April 18–20, 2010; Sperry Drilling Services data logs (drilling parameters), April 5–20, 2010.
109. Sperry Drilling Services data logs (drilling parameters with cement unit data), April 15–20, 2010; Sperry Drilling Services data logs (cement unit data), April 18–20, 2010; Sperry Drilling Services data logs (drilling parameters), April 5–20, 2010.
110. See Appendix G, 93–94; Sperry Drilling Services data logs (drilling parameters with cement unit data), April 15–20, 2010; Sperry Drilling Services data logs (cement unit data), April 18–20, 2010; Sperry Drilling Services data logs (drilling parameters), April 5–20, 2010.
111. Sperry Drilling Services data logs (drilling parameters with cement unit data), April 15–20, 2010; Sperry Drilling Services data logs (cement unit data), April 18–20, 2010; Sperry Drilling Services data logs (drilling parameters), April 5–20, 2010.
112. See Appendix G, 102–103.
113. Sperry Drilling Services data logs (drilling parameters with cement unit data), April 15–20, 2010; Sperry Drilling Services data logs (cement unit data), April 18–20, 2010; Sperry Drilling Services data logs (drilling parameters), April 5–20, 2010.
114. *Ibid.*
115. See Appendix G, 105; BP Investigation Team Interview of Don Vidrine, April 27, 2010, BP-HZN-0021406, 7, 24; Testimony of Joseph Keith, USCG/BOEM Marine Board of Investigation, December 7, 2010, 120:1–25, 121:1–2.
116. Appendix G See Appendix G, 105.
117. Rheliant Displacement Procedure, BP-HZN-MBI00170827.
118. See Appendix G, 99-100; Testimony of Gregory Meche, Hearing before the Deepwater Horizon Joint Investigation Team, May 28, 2010, 219:8-15.
119. See Appendix G, 30, 100; Sperry Drilling Services data logs (cement unit data), April 18–20, 2010.
120. See Appendix G, 29–30.
121. See Appendix G, 93–99.
122. Rheliant Displacement Procedure, BP-HZN-MBI00170827.
123. See Appendix G, 92.
124. See Appendix G, 93–94.
125. See Appendix G, 98–99.
126. See Appendix G, 30, 100.
127. BP Investigation Team Interview of Don Vidrine, April 27, 2010, BP-HZN-0021406, 19; Sperry Drilling Services data logs (drilling parameters with cement unit data), April 15–20, 2010; Sperry Drilling Services data logs (cement unit data), April 18–20, 2010; Sperry Drilling Services data logs (drilling parameters), April 5–20, 2010.
128. *Ibid.*
129. Sperry Drilling Services data logs (drilling parameters with cement unit data), April 15–20, 2010; Sperry Drilling Services data logs (cement unit data), April 18–20, 2010; Sperry Drilling Services data logs (drilling parameters), April 5–20, 2010.
130. Transocean Investigation Team Interview of Chad Murray, June 30, 2010.
131. *Ibid.*
132. Sperry Drilling Services data logs (drilling parameters with cement unit data), April 15–20, 2010; Sperry Drilling Services data logs (cement unit data), April 18–20, 2010; Sperry Drilling Services data logs (drilling parameters), April 5–20, 2010.
133. *Ibid.*
134. *Ibid.*
135. *Ibid.*

136. Transocean Investigation Team Interview of David Young, June 1, 2010; Sperry Drilling Services data logs (drilling parameters with cement unit data), April 15–20, 2010; Sperry Drilling Services data logs (cement unit data), April 18–20, 2010; Sperry Drilling Services data logs (drilling parameters), April 5–20, 2010.
137. See Appendix G, 113; Sperry Drilling Services data logs (drilling parameters with cement unit data), April 15–20, 2010; Sperry Drilling Services data logs (cement unit data), April 18–20, 2010; Sperry Drilling Services data logs (drilling parameters), April 5–20, 2010.
138. See Appendix G, 113; Sperry Drilling Services data logs (drilling parameters with cement unit data), April 15–20, 2010; Sperry Drilling Services data logs (mud pit data), April 19, 2010–April 20, 2010, BP-TO11000827; Sperry Drilling Services data logs (cement unit data), April 18–20, 2010; Sperry Drilling Services data logs (drilling parameters), April 5–20, 2010.
139. Transocean Investigation Team Interview of Caleb Holloway, May 28, 2010; Transocean Investigation Team Interview of David Young, June 1, 2010.
140. Sperry Drilling Services data logs (drilling parameters with cement unit data), April 15–20, 2010; Sperry Drilling Services data logs (mud pit data), April 19, 2010–April 20, 2010, BP-TO11000827; Sperry Drilling Services data logs (cement unit data), April 18–20, 2010; Sperry Drilling Services data logs (drilling parameters), April 5–20, 2010.
141. See Appendix G, 115.
142. Sperry Drilling Services data logs (drilling parameters with cement unit data), April 15–20, 2010; Sperry Drilling Services data logs (mud pit data), April 19, 2010–April 20, 2010, BP-TO11000827; Sperry Drilling Services data logs (cement unit data), April 18–20, 2010; Sperry Drilling Services data logs (drilling parameters), April 5–20, 2010.
143. See Appendix G, 115.
144. See Appendix G; Sperry Drilling Services data logs (mud pit data), April 19, 2010–April 20, 2010 BP-TO11000827.
145. Sperry Drilling Services data logs (drilling parameters with cement unit data), April 15–20, 2010; Sperry Drilling Services data logs (mud pit data), April 19, 2010–April 20, 2010, BP-TO11000827; Sperry Drilling Services data logs (cement unit data), April 18–20, 2010; Sperry Drilling Services data logs (drilling parameters), April 5–20, 2010.
146. See Appendix G, 116–117; BP Investigation Team Interview of Don Vidrine, April 27, 2010, BP-HZN-MBI00021406,21; Sperry Drilling Services data logs (drilling parameters with cement unit data), April 15–20, 2010; Sperry Drilling Services data logs (mud pit data), April 19, 2010–April 20, 2010, BP-TO11000827; Sperry Drilling Services data logs (cement unit data), April 18–20, 2010; Sperry Drilling Services data logs (drilling parameters), April 5–20, 2010.
147. See Appendix G, 131.
148. See Appendix G, 116–117.
149. *Ibid.* See Appendix G.
150. See Appendix G, 134–136; Testimony of Micah Sandell, Hearing before the *Deepwater Horizon* Joint Investigation Team, May 29, 2010, 9-11; Transocean Investigation Team Interview of Caleb Holloway, May 28, 2010.
151. BP Investigation Team Interview of Don Vidrine, April 27, 2010, BP-HZN-MBI00021406,21; Testimony of Micah Sandell, Hearing before the *Deepwater Horizon* Joint Investigation Team, May 29, 2010,9–11.
152. Testimony of Randy Ezell, Hearing before the *Deepwater Horizon* Joint Investigation Team, May 28, 2010, 283:3–13; Transocean Investigation Team Interview of Andrea Fleytas, June 24, 2010.
153. Testimony of Micah Sandell, Hearing before the *Deepwater Horizon* Joint Investigation Team, May 29, 2010:8–12.
154. See Appendix G, 134–136, 139; Testimony of Micah Sandell, Hearing before the *Deepwater Horizon* Joint Investigation Team, May 29, 2010, 9-11; Transocean Investigation Team Interview of Caleb Holloway, May 28, 2010; Sperry Drilling Services data logs (drilling parameters with cement unit data), April 15–20, 2010; Sperry Drilling Services data logs (mud pit data), April 19–20, 2010, BP-TO11000827; Sperry Drilling Services data logs (cement unit data), April 18–20, 2010; Sperry Drilling Services data logs (drilling parameters), April 5–20, 2010.
155. See Appendix G, 119–120; Sperry Drilling Services data logs (drilling parameters with cement unit data), April 15–20, 2010; Sperry Drilling Services data logs (mud pit data), April 19, 2010–April 20, 2010, BP-TO11000827; Sperry Drilling Services data logs (cement unit data), April 18–20, 2010; Sperry Drilling Services data logs (drilling parameters), April 5–20, 2010.
156. Sperry Drilling Services data logs (drilling parameters with cement unit data), April 15–20, 2010; Sperry Drilling Services data logs (mud pit data), April 19, 2010–April 20, 2010, BP-TO11000827; Sperry Drilling Services data logs (cement unit data), April 18–20, 2010; Sperry Drilling Services data logs (drilling parameters), April 5–20, 2010.

157. See Appendix G, 119–120.

158. Sperry Drilling Services data logs (drilling parameters with cement unit data), April 15–20, 2010; Sperry Drilling Services data logs (mud pit data), April 19, 2010–April 20, 2010, BP-TO11000827; Sperry Drilling Services data logs (cement unit data), April 18–20, 2010; Sperry Drilling Services data logs (drilling parameters), April 5–20, 2010.

3.3 Drill Floor Activities

3.3 Drill Floor Activities

This section examines data recovered from the *Deepwater Horizon* well monitoring equipment before the explosion on the rig floor that ended communications at approximately 9:49 p.m. To the extent possible, the investigation team attempted to put the events in context and reconstruct them from the perspective of those on the drill floor during the last moments of the well incident, from the static sheen test through the drill crew's activation of the blowout preventer (BOP) by the drill crew.

As recognized in *Chapters 3.1 and 3.2*, the men who lost their lives are the only ones who know the exact events that occurred on the *Deepwater Horizon* drill floor and shaker house on the evening of April 20, 2010. It may never be known what information the drill crew had and why they made certain decisions at a given moment.

After exhaustive analysis of available data, the investigation team has concluded that in carrying out their well monitoring responsibilities, the actions of the Transocean drill crew were indicative of a belief that the well was secure. The investigation team concluded that the drill crew trusted that:

- The float collar converted.
- Cement had sufficient time to set.
- The positive casing test confirmed the integrity of the seal assembly and casing.
- The negative pressure test confirmed the integrity of the float collar and cement at the bottom of the well.
- The displacement could safely continue as directed by BP.
- The BP company man and Sperry Sun mud logger confirmed that the well was not flowing.

Set forth below is a reconstruction by the investigation team of the events that followed, based on post-incident analysis and investigation and customary industry practices, with observations as to actions taken by the drill crew.

3.3.1 Well Monitoring Data Systems

The drillers had multiple ways to receive well monitoring data, including a system called Cyberbase created by Hitec, a drilling controls equipment provider. Another data system was operated by Sperry Sun, a Halliburton subsidiary contracted by BP to provide additional well monitoring services. Both of these systems provided real-time data on well conditions that each driller could view on computer screens in the drill shack. This data also was viewable to multiple parties throughout the rig, including the BP well site leaders, on dedicated monitors or a closed-circuit television (CCTV) system in their offices.

Hitec Drilling System

The primary source of information available to and used by the drill crew about the well and the surface equipment was the NOV Hitec Cyberbase drilling system (Hitec), which was used to operate drilling machinery and monitor drilling system sensors. The Hitec sensors indicated, among other things, flow of fluids into and out of the well, pressures, pit volumes, and surface equipment operation; therefore, it was utilized during displacement operations.¹ The driller, assistant driller, toolpusher, and offshore installation manager (OIM) relied on Hitec data in monitoring the well.² The system displayed this data in real time on the drilling control station located on the rig floor. *See Figure 1.* The Hitec display screens used by the driller could be viewed on a dedicated channel of the rig CCTV, which was available throughout the rig, including in the crew cabins and the mud logger's shack.³ In addition, the BP onsite leaders' offices were equipped with a Hitec display terminal that allowed selection of what Hitec data to display.⁴



Figure 1 Deepwater Horizon Drilling Control Station

Deepwater Horizon Drilling Control Station

The following images are examples of the drill floor screens as they may have represented the data displayed up to the time of the incident. Data from the drill crew's primary Hitec monitors was lost with the rig and was not included in the data transmitted to the onshore team in real time. Therefore, no record remains of what the drill crew would have seen on those screens.

To address this absence of evidence, the investigation team took information from the secondary Sperry Sun monitoring system and projected it into Hitec screens to illustrate how trends and other well data might have appeared to the drill crew. These simulations are for illustrative purposes only. It is important to note that assessing the screens in this static, hindsight fashion is significantly different from monitoring the data as it appears on the screens in real time in the driller's control room.

The Hitec system data was viewed on two screens oriented side-by-side in front of the drillers. See Figure 2. During drill floor operations, the driller and the assistant driller would have used the left drilling screen primarily to monitor the well for pressure, flow, weight, and pump stroke data, which was presented as an instantaneous snapshot of a given moment in time.⁵

Conversely, the right Hitec monitor displays graphs depicting trends in pressure, flow, and weight in rolling 30-minute intervals. The vertical graph scale varies based on the metric being tracked. For example, the drill pipe pressure (i.e., well pressure) typically is displayed on a scale of 0–7,500 psi. The hook load, which shows the overall weight of the drill string, typically is displayed on a scale of 0–1,500 kilo pounds.⁶

The driller and assistant driller, as well as the BP onsite leader, used the right screen to distinguish trends over a period of time.⁷ This trending screen also served as a reference for the real-time data displayed on the left screen.⁸

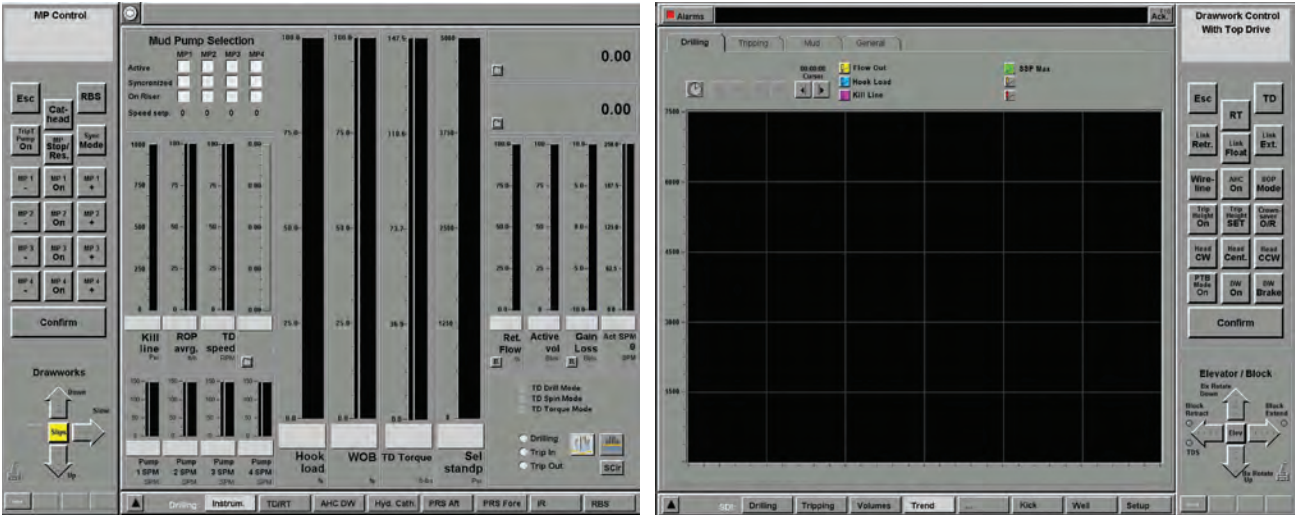

Figure 2 Hitec Display Screens

The driller can change the screen views from more reduced scales to monitor operations to larger-scaled graphs that show trends occurring over longer periods. In addition, screens must be switched over to locate and identify valve configurations and diagnose technical alerts. Screen views could be customized by users to switch to preset displays.⁹ Because of these customization options, the investigation team cannot determine precisely what was shown on the drill crew’s Hitec screens at the time of the incident.

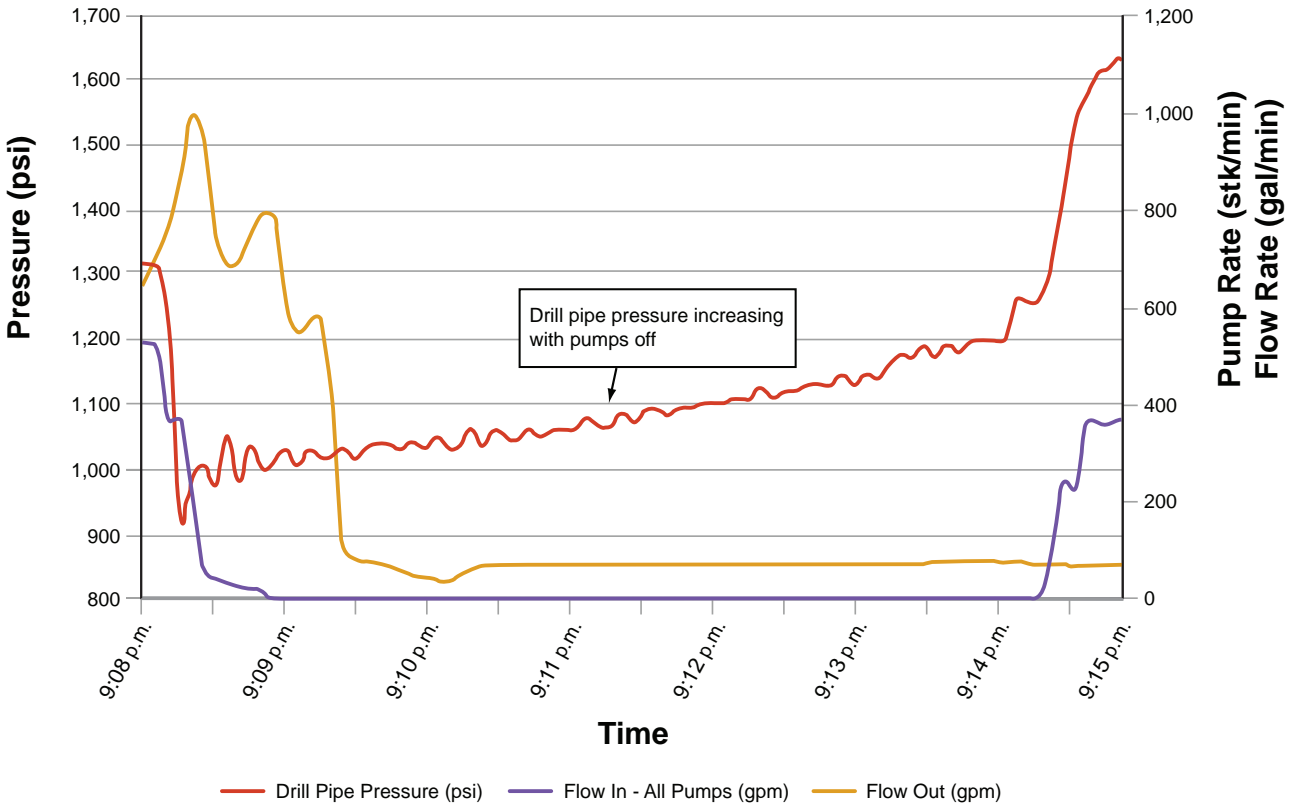

Figure 3 Sheen Test Chart from BP Deepwater Horizon Accident Investigation Report



Figure 4 Sheen Test on Simulated Hitec Screen

Several of the investigative reports on the Macondo incident err in their conclusions in this area of well data monitoring, assuming and portraying the information viewed by the drill crew in a misleading fashion. For example, multiple analyses assume the driller was monitoring drill pipe pressure using a 0–1,700 psi scale display on the Hitec screen. See Figure 3. While such scale adjustments are useful in post-incident analysis as a method of identifying trends, the driller’s screen typically would display pressures in a 0–7,500 psi scale. See Figure 4.

Closed-Circuit Television System

A CCTV system provided views of critical working areas to the drillers’ work station and to all the televisions on the rig.¹⁰ Cameras were placed at strategic points throughout the rig to assist with well monitoring. For example, cameras monitored the gumbo box, a container that receives flow from the well, to visually monitor well activity and detect flow; cameras were also placed in the derrick to monitor pipe placement. See Figure 5.



Figure 5 Closed-Circuit Cameras on the *Deepwater Horizon*

Sperry Sun Drilling Monitor System

BP contracted Sperry Sun to install, maintain, and operate a secondary drilling monitoring system that transmitted downhole well data, such as tool direction and pressure while drilling. The Sperry Sun system accumulated various data such as:

- A drilling tool's direction and inclination, monitored by Measurement While Drilling (MWD)
- The gamma ray tool and resistivity tool, monitored by Logging While Drilling (LWD)
- The hydrostatic pressure in the well and equivalent circulation density (ECD) — an important measure in preventing fluid losses into the formation, particularly in a well such as Macondo with a narrow window between the fracture gradient and the pore-pressure gradient — monitored by Pressure While Drilling (PWD)

The Sperry Sun monitors, which displayed some Hitec sensor data as well, were located on the drill floor and at Sperry Sun mud logger workstations. The Sperry Sun data was transmitted to the offices of BP well site leaders, toolpushers, OIMs, and anyone with CCTV access. Additionally, Sperry Sun information was recorded in real time and available to the BP shore-based well team and its partners. See *Figure 6*.

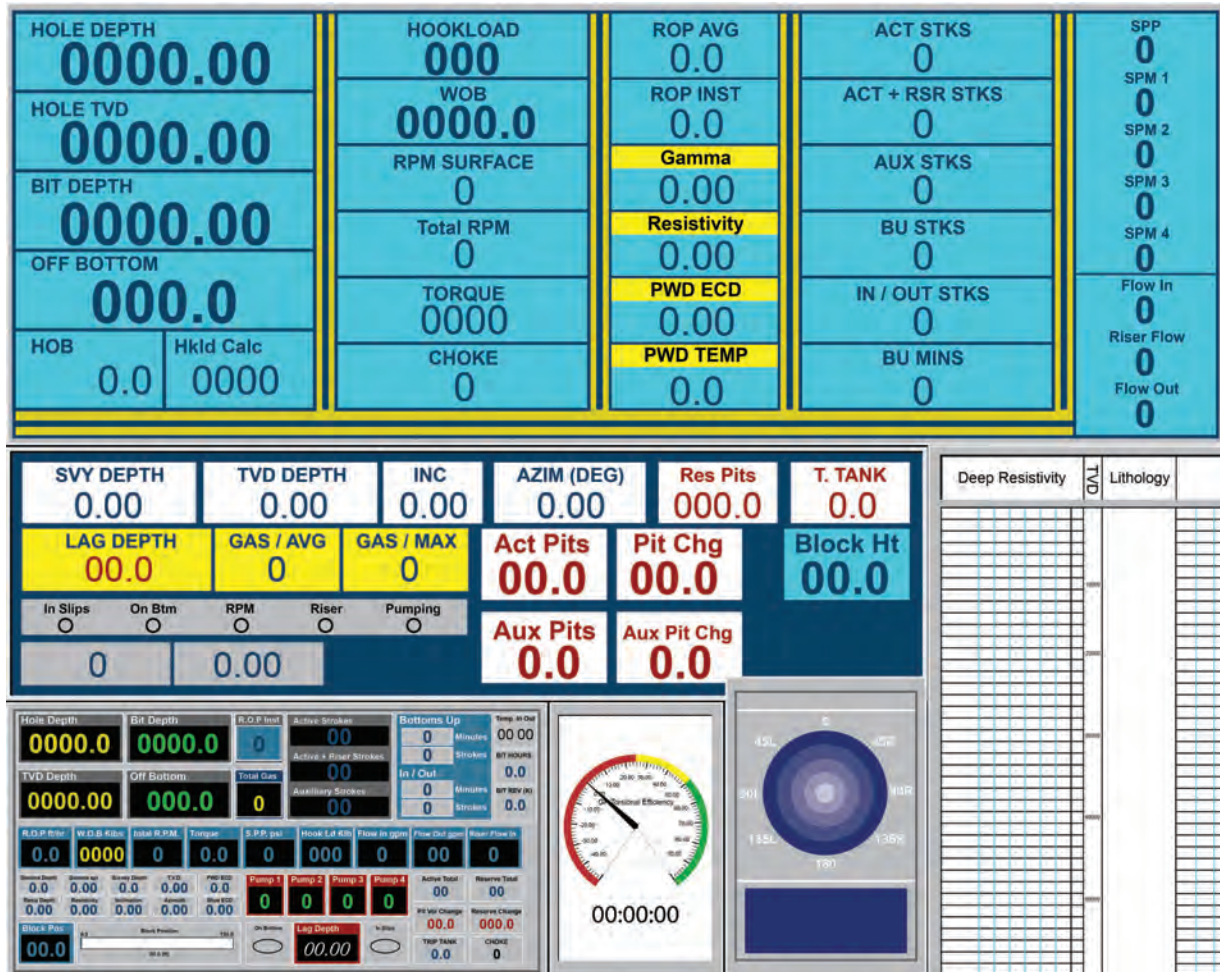

Figure 6 Simulated Sperry Sun Screen

The figure above was created from photos of a Sperry Sun screen taken on the *Deepwater Horizon* prior to the incident and is intended solely to give a sense of the type of information displayed and its layout. Trending data is displayed in the lower right corner of the screen.

3.3.2 Displacement Operations Up to the Sheen Test

At approximately 8:02 p.m., the BP well site leader concluded that the negative pressure test was successful and proceeded with the final displacement.¹¹ Analysis of the available data shows that during this final displacement, the well became underbalanced between 8:38 p.m. and 8:52 p.m. due to a failed cement barrier, but that there was no clear indication of an influx at that time.¹² As discussed below, post-incident analysis by the investigation team concludes that indications of the influx were masked by normal and expected flow variations while the trip tank emptied, and subtle pressure indications of the influx were nearly undetectable on the 0–7,500 psi scale likely represented on the Hitec monitors.

During the displacement operation, the trip tank (a small receptacle used to ascertain flow from the well in the absence of pump activity) slowly filled with oil-based mud for about 20 minutes, likely due to the hole-fill valve being left open from the previous operation.¹³ Because the mud in the trip tank was oil-based, environmental regulations required that it be returned to the mud pits rather than discharged overboard.

To transfer this mud to the pits, the driller turned on a small pump to empty (dump) the trip tank into the flow line at 8:58 p.m.; a corresponding increase in return flow registered in the Sperry Sun data.¹⁴ The flow was relatively steady until a very subtle increase at 9:04 p.m., which seems to have indicated an influx of hydrocarbons in

the well.¹⁵ It is believed that the driller saw an expected flow increase and subsequent decrease as the trip tank pump was turned on and off, respectively, which masked evidence of the influx. Based on post-incident calculations, the investigation team determined that approximately 16.5 barrels (bbl) of hydrocarbons entered the well during the course of the trip tank dump. See Figure 7.

By 9:06 p.m., the flow from the well decreased as expected when the trip tank pump was turned off; however, post-incident analysis showed that it did not drop back to the previous level.¹⁶ The flow then began to increase again and continued to rise until 9:08 p.m. At that time, the driller stopped the mud pumps by selecting the “stop/resume” button on the control system so the compliance engineer could conduct the sheen test. The pumps ramped down over a two minute, pre-programmed cycle. Drill pipe pressure decreased as expected during this period. The pressure then remained constant for a period of 40–50 seconds, reflecting a stable well condition.

There is no evidence that the driller was given guidance within the displacement procedure by BP as to the expected pressure at this point in the displacement, information that typically would be given in a pump-displacement curve. At this point in the displacement, based on post-incident analysis of the Sperry Sun real-time data, the actual drill pipe pressure reading was near 1,050 psi, but the drill pipe pressure reading with the pumps off and spacer at the surface should have been in the range of 500–600 psi.

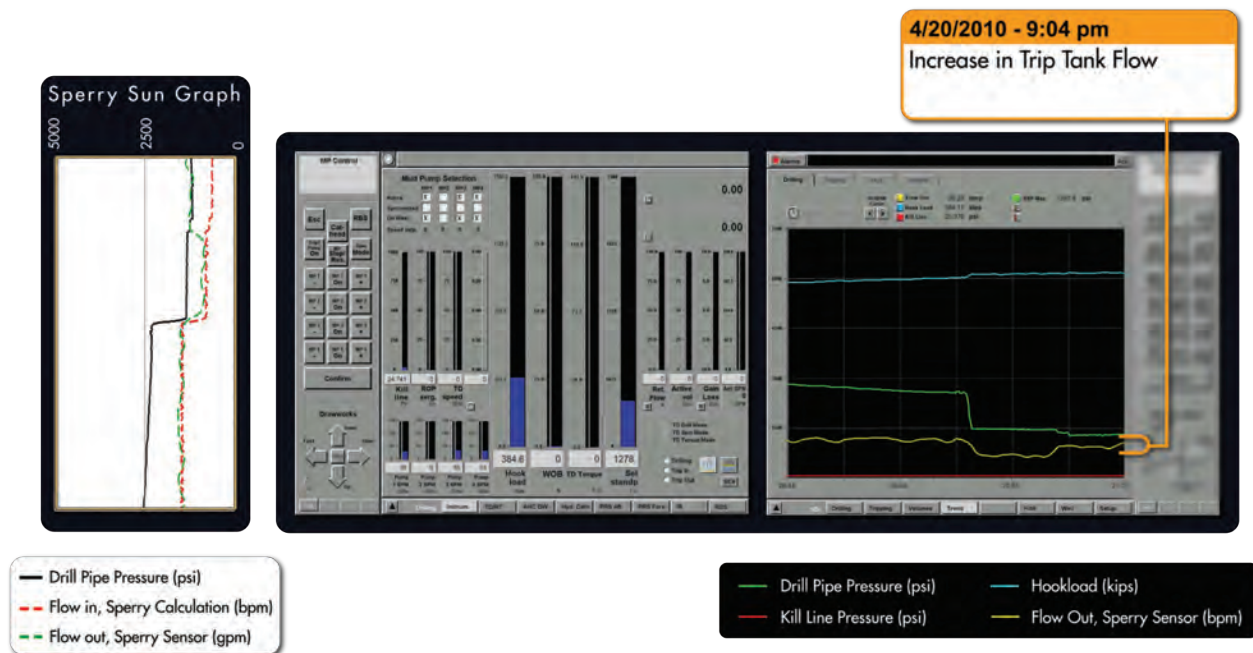

Figure 7 9:04 p.m. Increase in Flow during Trip Tank Dump

3.3.3 Sheen Test

The heavy fluids in the riser were comprised of mud and spacer. As the mud was displaced with seawater, mud should have reached the surface first, followed by the spacer and then the returning seawater. These activities were led by M-I SWACO, a drilling fluids contractor responsible for the maintenance and monitoring of the mud and spacer, as well as ensuring that all fluid discharges complied with environmental regulations.

Once the driller reached the pre-determined number of pump strokes that he had been instructed to use to bring the spacer to the surface, the pumps were shut down for the compliance engineer to conduct the sheen test to verify it was time to begin pumping the spacer overboard.

As discussed in Chapter 3.2.4, the overboard discharge bypassed the Sperry Sun sensor. Statements indicate that the gumbo box valve was closed and thus any fluids returning from the well would bypass the Sperry Sun flow sensor and be diverted directly overboard. This removed the Sperry Sun sensor from the flow path for the remainder of the displacement;¹⁷ flow data was no longer transmitted, and flow could not be monitored on the gumbo box via the CCTV as the overboard line is routed around the gumbo box.¹⁸

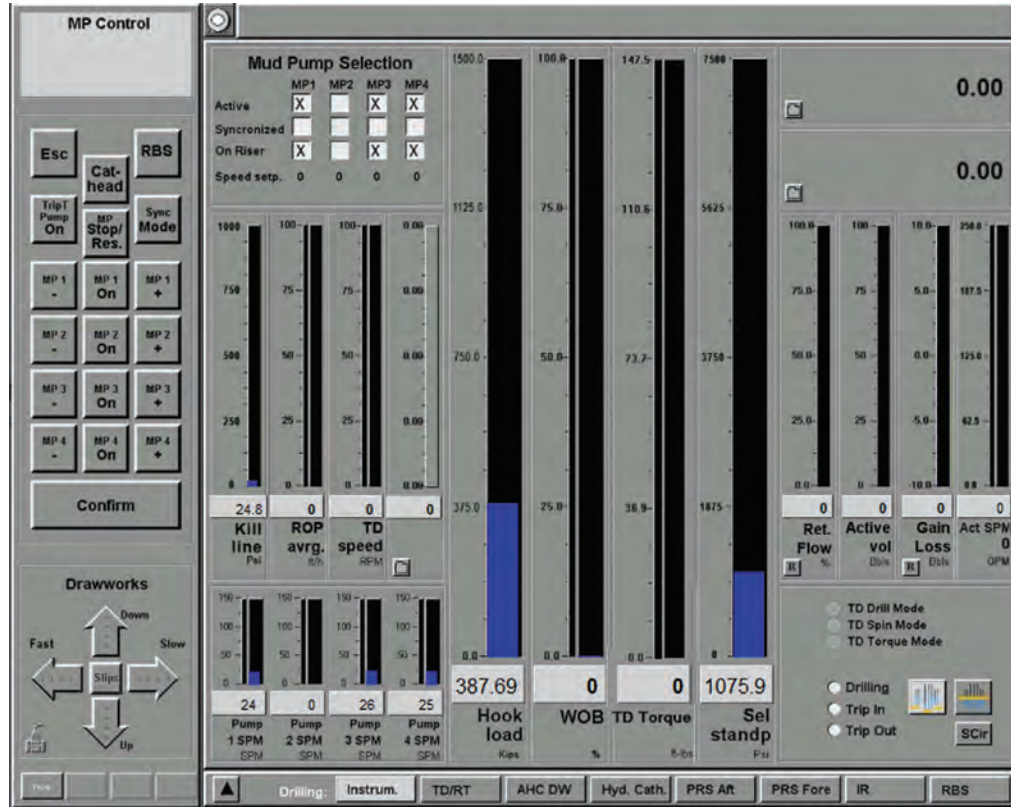

Pressure at 9:08 p.m. (Start of Sheen Test)

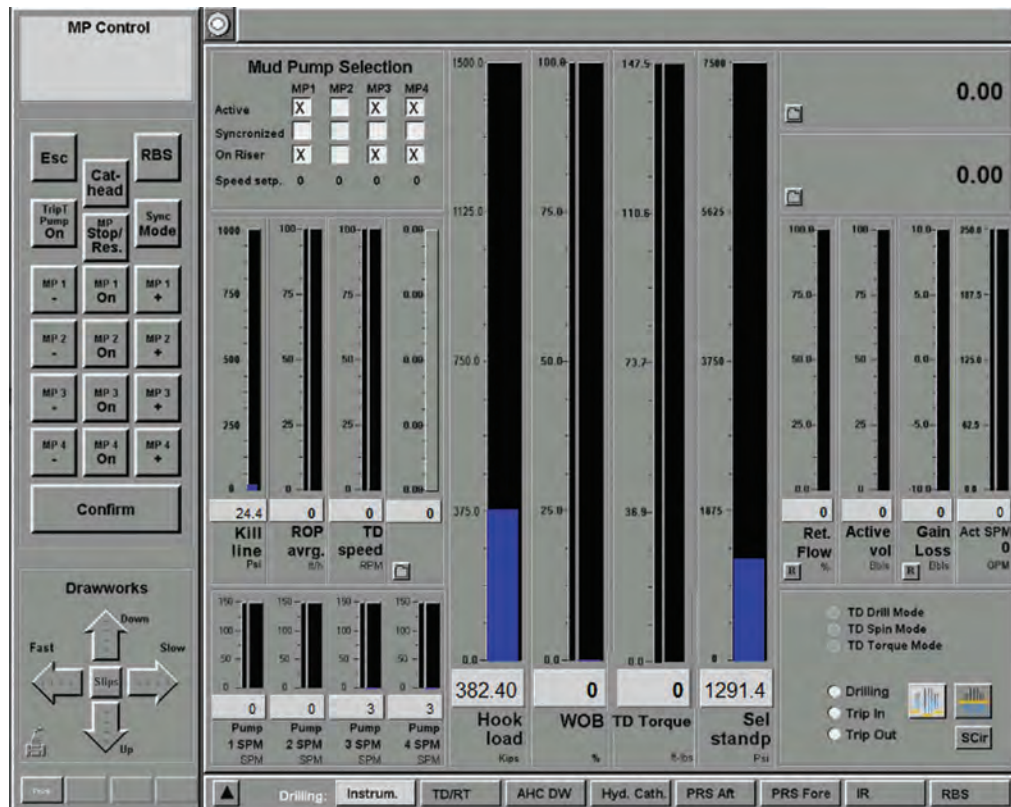

Pressure at 9:14 p.m. (End of Sheen Test)
 Figure 8 Change in Drill pipe Pressure from 9:08–9:14 p.m.



Figure 9 9:14 p.m. End Static Sheen Test

The Sperry Sun mud logger and the BP onsite leader said their visual checks confirmed the well was not flowing once the pumps stopped and prior to directing flow overboard.^{19, A}

The investigation team calculated that by the time the drill crew shut down the pumps for the sheen test, approximately 61 bbl of hydrocarbons had flowed into the well.²⁰ This volume gain may have gone undetected due to the reasons outlined in *Chapter 3.2*.

During the four minutes it took to complete the sheen test, an additional 33 bbl of hydrocarbons entered the well at an average of 8.25 barrels per minute (bpm). It is believed the crew already was set up to send flow overboard at the beginning of the sheen test period while waiting for the test results. If so, fluid flow that reached the surface during the sheen test would have been routed around the gumbo box and flowed overboard.²¹

During the sheen test, post-incident analysis reflects that pressure gradually increased by 189 psi. The investigation team believes this may not have been readily observed on the 0–7,500-psi display monitored by the drill crew, as explained previously.²² See *Figures 8 and 9*. Post-incident analysis of the data shows that for the first 30–40 seconds after the pumps were shut down, the pressure appeared stable. Given stable pressure readings and confirmation of no flow from the shaker room, the driller would have then likely prepared for the next displacement phase by setting up mud pump 2 to pump down the kill and choke lines.

The sample used by the mud engineer to conduct the sheen test weighed 15.4 ppg. This is an indication that the interface between the 14-ppg SOBMs and the 16-ppg spacer was at surface, but the sample would have contained nearly 30% oil-based mud.²³ The sample results indicate it should not have passed a sheen test and, therefore, pumping should have continued to the pits, not overboard, until a clean sample was obtained.

A For example, see gumbo box camera picture in *Figure 5*

3.3.4 Preparations for Final Displacement of Spacer

After the compliance engineer and BP well site leader passed the sheen test, non-SOBM fluid could be routed overboard. Before beginning displacement, the driller normally would, and probably did, call the shaker room to verify that the flow line had been routed overboard. The driller likely also called the pit/pump room to confirm that mud pump 2 was set up to pump seawater down the choke and kill lines,²⁴ while the floor hands and the assistant driller configured the manifolds on the rig floor.

The set up was complete and operations to pump overboard began at 9:14 p.m. The Sperry Sun data shows that the driller first brought pumps 3 and 4 online to pump seawater down the drill pipe and brought pump 1 online to push fluids up the riser through the boost line. Bringing pumps 3 and 4 online caused an expected increase in drill pipe pressure, as shown on the Sperry Sun chart.²⁵

During displacement, the driller watches the drilling monitor for trends so that variations can be identified, investigated, and resolved. From 9:14 p.m. until 9:17 p.m., these three pumps were brought online and gained speed. This caused an expected, gradual, and linear increase in the drill pipe pressure — the trend that would be expected.²⁶

As explained above, pumps 3 and 4 pushed fluid down the drill pipe, while pump 1 displaced the riser. The continued increase in pressure shown on the Sperry Sun data after pump 1 was brought online may have been interpreted by the driller as a correct trend: an increase in drill pipe pressure. Post-incident analysis indicates, however, that only the speed variations of pumps 3 and 4, not pump 1, would affect drill pipe pressure.

During this time, the investigation team believes that well flow most likely was masked by the normal, expected pressure increases as mud pumps 3 and 4 were brought up to speed.

3.3.5 Relief Valve Activation

The driller brought pump 2 online at 9:17 p.m., after pump 1 reached its operating rate. The discharge pressure of pump 2 immediately spiked to more than 7,000 psi. The most likely cause of the pressure spike, as determined by the investigation team, was a closed discharge valve in the drill floor manifold from an incomplete line-up at the surface. This pressure spike activated the relief valve, which is designed to “pop off” and vent to reduce pressure.²⁷

The pressure spike and drop is a standard indication that a relief valve “popped off” and would have to be replaced. The driller immediately shut down pumps 2, 3, and 4 to identify the affected pump, and, based on standard practice, the driller called the pump hand to determine which relief valve had activated and would need to be replaced.

Pump 1, the riser boost line pump, remained online during the drill crew investigation.²⁸

The relief valve on pump number 2 had activated, and the driller assigned one of the assistant drillers, two of the floor hands, and the pump hand to replace the relief valve on pump 2.²⁹

While pumps 2, 3, and 4 were stopped during this 20-second interval, drill pipe pressure fell. This pressure drop would be a normal pressure trend upon the shutdown of the pumps.

TREND MONITORING

Trends in signals are an important part of monitoring well parameters. At any given moment, data signals may change instantaneously as a result of rig movement, crane operations, or actions taken to adjust drilling parameters, such as adjustment of pump speed. Therefore, the underlying trend of signals that occur over minutes, not seconds, gives the most meaningful indication of well condition. It can take several minutes for an identifiable trend to develop and become apparent to the persons monitoring the information.

Post-incident investigations have attempted to identify trends, as they existed on April 20, 2010, based on a still-shot, which was enlarged, analyzed and studied. When evaluating the conduct of the drill crew on April 20, 2010, it is important to recognize that the studied review of data over multiple months with the benefit of hindsight and knowledge of the ultimate outcome is wholly different from monitoring trends in real time.

After determining that pump 2 was in fact the affected pump, the driller brought pumps 3 and 4 back online within 20 seconds of their being shut off. The driller’s investigation to identify the relief valve “pop off” would have transpired within 30 seconds.

3.3.6 Monitoring Pump Trends

Shortly after the relief valve issue was resolved, as pumps 3 and 4 ramped up, the drill pipe pressure increased. This is a normal pressure trend upon activating pumps lined up to pump down the drill pipe.

For the next few minutes, with pumps 3 and 4 online, the driller then increased the strokes per minute on pump 1 to increase the displacement velocity in the riser.³⁰ This increase of the stroke count on pump 1 normally would be visually monitored by the driller on the left screen of his display (as opposed to the pressure trending display) to make sure the pump reached the proper stroke count. The Sperry Sun data reflects that the driller used the stop/resume function on the driller’s control panel. This function smoothly ramps up the mud pumps to a pre-set pump rate over a two-minute interval.

The use of the stop/resume function produced the expected increase in pressure. During the few minutes that the stroke count of pump 1 was increased and pumps 3 and 4 reached their set stroke rate, the drill pipe pressure increased and appeared to level out, as would be expected, by 9:21 p.m.

The driller then manually increased the pump rates on pumps 3 and 4 to increase the rate of the final displacement, which can be seen in the Sperry Sun real time data. Again, the increased pump rate coincided with a normal expected steady increase in the drill pipe pressure for the next five minutes, until 9:27 p.m. By 9:27 p.m.,³¹ the drill pipe pressure was decreasing as would be expected with the heavy spacer being displaced out of the well and overboard.

3.3.7 Kill Line Activity and Differential Pressure

The pressure on the kill line began to increase very gradually at 9:22 p.m. after the valve had been opened. From 9:26–9:27 p.m., pressure increased to 833 psi.³² See Figure 10. The investigation team could not determine a reason for the erratic pressure build — initially slow and then more rapid in the kill line pressure reading. The kill line could have been plugged with spacer material. Within the next two minutes, the drill crew likely discussed the anomalous differential pressure readings between the kill line and drill pipe.³³ The investigation team believes this is the first indication that the drill crew recognized an anomaly in the well.



Figure 10 9:27 p.m. Kill Line Pressure Climbs to 833 psi.

The Sperry Sun data shows that at 9:29 p.m., the drill crew shut down the pumps, likely to assess the significance of the pressure readings. Pumps 3 and 4 were stopped first, followed by pump 1.³⁴ At 9:31 p.m., the drill pipe pressure fell due to the shutdown of the pumps but did not match the kill line pressure as it should have.³⁵ See Figure 11. The investigation team believes that the drill crew monitored the pressure after the final pump ramped down to observe a trend. Once the pumping activity ceased, the well should have been in a static state, with no pressure changes evident; from 9:31–9:32 p.m., the pressure remained constant.

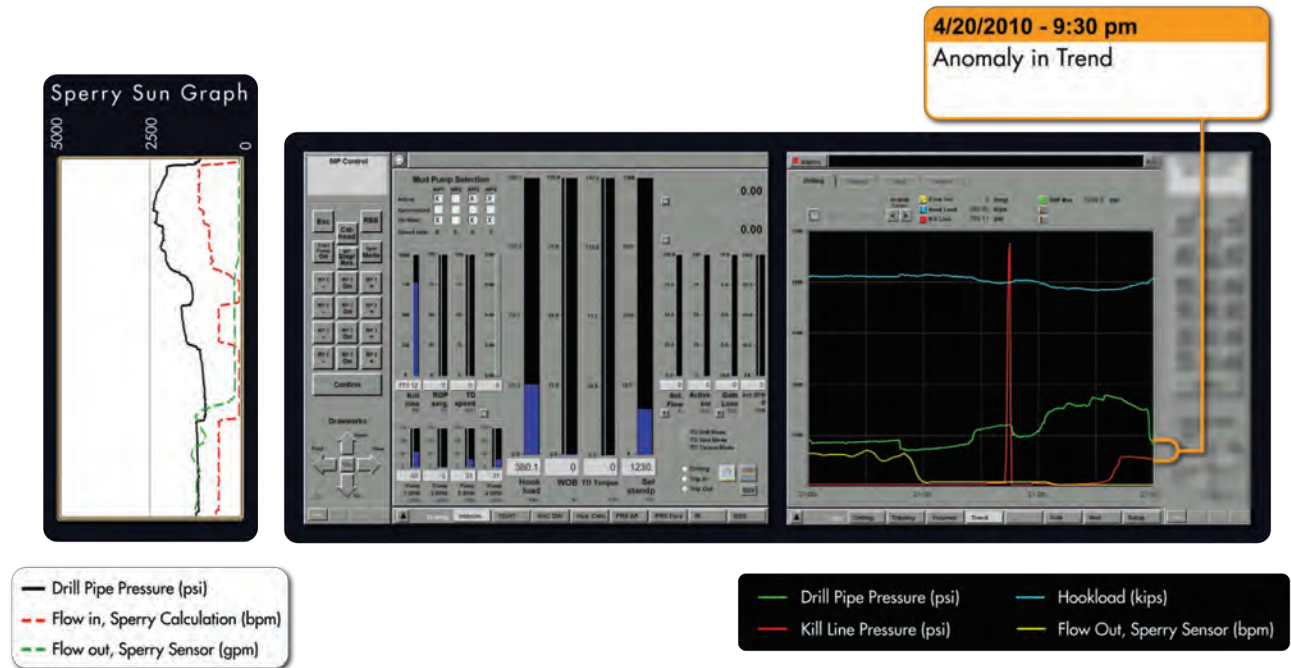

Figure 11 9:31 p.m. Pumps Stopped to Determine Pressure Difference

During the discussion of the anomaly, the drill pipe pressure rose from 1,400 psi to 1,800 psi between 9:32 p.m. and 9:34 p.m., when it again leveled and became constant.³⁶ See Figure 12. What the drill crew did not know was that the constant pressure was due to 14-ppg mud, which was now moving into the riser. As it moved, the heavy fluid column began to shorten in height and nearly balanced the change in pressure from spacer moving out of the riser and down the flow line. A condition existed where fluids were moving and the pressures were remaining constant due to the specific combination of fluid densities in the well and the geometry of the wellbore. The discussion likely turned to what caused the increase in the drill pipe pressure and why it did not match the kill line pressure.



Figure 12 9:34 p.m. Pressure Increase With Pumps Offline

3.3.8 Drill Pipe Bleed and Recognition of Influx

At 9:36 p.m., the driller instructed a floor hand to bleed the drill pipe on the standpipe manifold, and for the next one-and-a-half minutes, flow was taken from the drill pipe.³⁷ Based on the experience and work of the investigation team, the team concluded that the action taken to bleed pressure from the drill pipe is consistent with a belief by the driller that a plug existed. At this time, the well had taken more than 385 bbl of fluid from the formation and was flowing at more than 38 bpm with mud and hydrocarbons still below the drill string.³⁸ The driller instructed the floor hand to close the valve when the drill pipe pressure approached the kill line pressure.³⁹ Once the drill pipe was shut in, the drill pipe pressure immediately built to 1,400 psi, 300 psi lower than before the bleed off, and then remained constant until 9:39 p.m.⁴⁰ See *Figure 13*. It is apparent the drill crew was taking measures to understand the well condition. From analysis work by the investigation team, the lower pressure after the bleed-off indicates that mud was still below the drill string at this time, as it was sucked into the drill pipe and caused a lower pressure reading when the valve was closed.

At 9:39 p.m., the drill pipe pressure began to decline as hydrocarbons began to move upward past the end of the drill pipe. The pressure drop is a clear signal to a driller of a kick as, under normal drilling conditions, when hydrocarbons enter the well, they will lower pressure readings. The driller routed the well returns to the trip tank to check for flow. By 9:42 p.m., the trip tank began to fill rapidly, and the driller recognized the well was flowing.⁴¹ See *Figure 14*.

At approximately 9:43 p.m., the crew took action to contain the well by shutting in the upper annular blowout preventer (BOP) element, then activating the diverter at 9:45 p.m., and then closing the variable bore rams at 9:47 p.m.⁴² These activities are discussed in detail in *Chapter 3.4*.

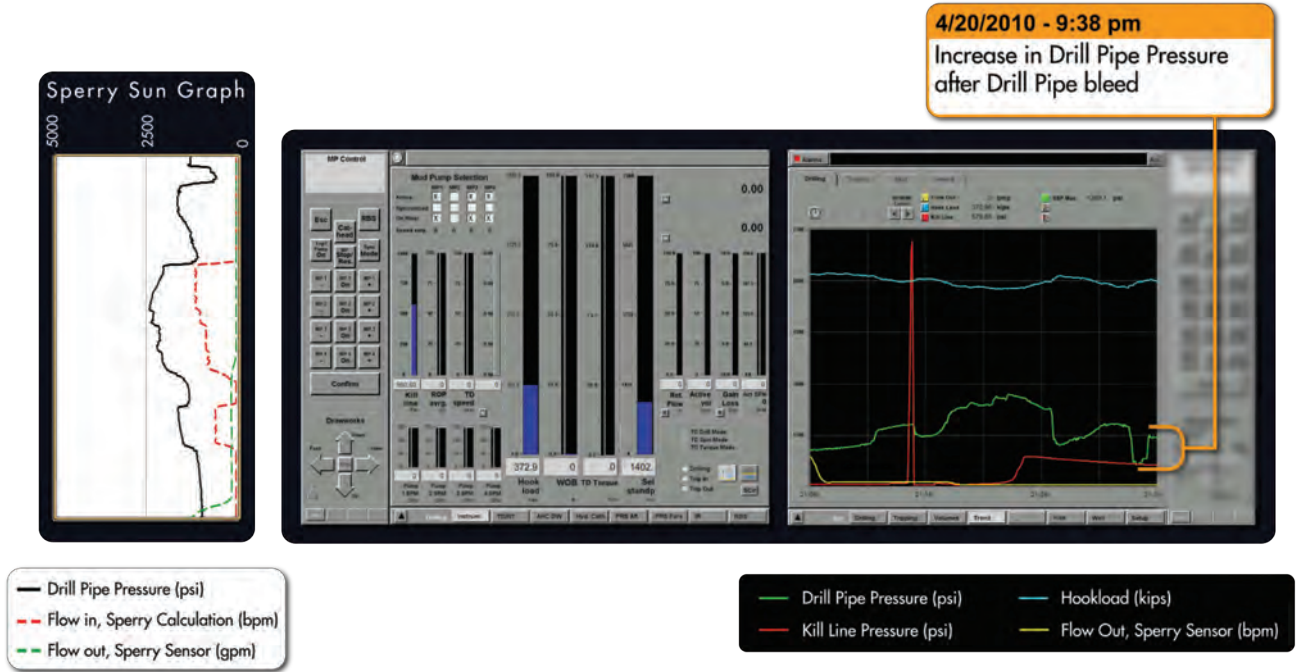

Figure 13 Drill Pipe Pressure Builds after Bleed



Figure 14 9:42 p.m. Trip Tank Fills

3.3.9 Drill Floor Activities Findings of Fact and Investigation Team Observations

Findings of Fact

- The driller was not provided guidance for what pressure readings should be during the process of displacing the well. If available, this would have provided a second method to check progress of the displacement to ensure fluid interfaces were at expected locations in the well.
- The resulting mud weight from the sheen test indicated that an interface with approximately 30% oil-based mud was at surface and should not have passed a sheen test to approve the discharge of fluids overboard.
- The dumping of the trip tank at the end of displacement and prior to the sheen test masked an influx signal.
- Upon lining up the trip tank and confirming that the well was flowing, the drill crew responded in an attempt to shut in the well. The hydrocarbons simultaneously reached the riser with these actions.

Observations

While it can never be known what the drill crew saw on its monitors during the well incident, the investigation team has determined the following through exhaustive analysis of available data and reconstruction of the procedures directed by BP:

- Had the uncertainty surrounding various tests and procedures to confirm the integrity of the well, and the risks inherent therein, been properly communicated to the drill crew by the operator, the crew's decisions may have reflected this knowledge and thus certain actions may have differed.
- Other reviews have failed to accurately portray the actual drill pipe pressure information viewed on the drillers' Hitec monitors. While these scale adjustments are useful in hindsight analysis of the events to more clearly identify trends, they do not reflect the true conditions faced by the drillers.
- Pressure anomalies on the Hitec monitors may have been masked by expected pressure changes resulting from the change in pump rates. A visual flow check was conducted during the sheen test, and the fact that no flow was observed and reported to the driller contributed to a false confirmation that the well was secure.
- The activation of and efforts to repair the relief valve on pump 2 may have distracted the drill crew.
- No one with access to the well monitors realized there was a problem during procedures to displace the well in preparation for temporary abandonment.

1. FDS – Cyberbase Control System, June 16, 2000, TRN-TBD-000000123.
2. Job Description (Rig-Based) Drilling Department/Assistant Driller 01/01/2001, 0/01/2001.
3. Testimony of Joseph Keith, Hearing before The Joint United States Coast Guard/Bureau of Ocean Energy Management Investigation, Dec. 7, 2010.
4. Transocean investigation team Interview of Patrick Cox, June 16, 2010.
5. Transocean Investigation Team Interview of John Carroll, June 11, 2010.
6. Transocean Investigation Team Interview of David Theunissen, March 2, 2011.
7. Transocean Investigation Team Interview of Patrick Cox, Oct. 20, 2010.
8. FDS – Cyberchair Control System, June 16, 2000, TRN-TBD-000000123.
9. *Ibid.*
10. FDS – Cyberchair Control System, June 16, 2000, TRN-TBD-000000123.
11. Stress Engineering Services, Inc., Hydraulic Analysis of Macondo #252 Well Prior to Incident of April 20, 2010; Testimony of Gregory Meche, Hearing before the Deepwater Horizon Joint Investigation Team, May 28, 2010, 175:11 - 176:12; Rheliant Displacement Procedure, BP-HZN-MBI00170827.
12. Stress Engineering Services, Inc., Hydraulic Analysis of Macondo #252 Well Prior to Incident of April 20, 2010.
13. Sperry Drilling Services data logs (mud pit data), April 19–20, 2010, BP-TO11000827.
14. Sperry Drilling Services data logs (drilling parameters), April 5–20, 2010; Sperry Drilling Services data logs (mud pit data), April 19–20, 2010, BP - TO11000827.
15. Sperry Drilling Services data logs (drilling parameters), April 5–20, 2010; Sperry Drilling Services data logs (mud pit data), April 19–20, 2010, BP - TO11000827.
16. Sperry Drilling Services data logs (drilling parameters), April 5–20, 2010.
17. Sperry Drilling Services data logs (drilling parameters), April 5–20, 2010.
18. BP Investigation Team Interview of Donald Vidrine, April 27, 2010, BP-HZN-MBI-0021406.
19. *Ibid.*
20. Stress Engineering Services, Inc., Hydraulic Analysis of Macondo #252 Well Prior to Incident of April 20, 2010.
21. *Ibid.*
22. Sperry Drilling Services data logs (drilling parameters), April 5–20, 2010.
23. Stress Engineering Services, Inc., Hydraulic Analysis of Macondo #252 Well Prior to Incident of April 20, 2010.
24. Sperry Drilling Services data logs (drilling parameters), April 5–20, 2010.
25. *Ibid.*
26. *Ibid.*
27. Stress Engineering Services, Inc., Hydraulic Analysis of Macondo #252 Well Prior to Incident of April 20, 2010.
28. Sperry Drilling Services data logs (drilling parameters), April 5–20, 2010.
29. Transocean Investigation Team Interview of Chad Murray, June 30, 2010.
30. Sperry Drilling Services data logs (drilling parameters), April 5–20, 2010.
31. *Ibid.*
32. Stress Engineering Services, Inc., Hydraulic Analysis of Macondo #252 Well Prior to Incident of April 20, 2010.

33. Stress Engineering Services, Inc., Hydraulic Analysis of Macondo #252 Well Prior to Incident of April 20, 2010; Testimony of David Young, Hearing before the Deepwater Horizon Joint Investigation Team, May 27, 2010, 239.
34. Sperry Drilling Services data logs (drilling parameters), April 5–20, 2010.
35. Stress Engineering Services, Inc., Hydraulic Analysis of Macondo #252 Well Prior to Incident of April 20, 2010.
36. Stress Engineering Services, Inc., Hydraulic Analysis of Macondo #252 Well Prior to Incident of April 20, 2010; Sperry Drilling Services data logs (drilling parameters), April 5–20, 2010.
37. Transocean Investigation Team Interview of Caleb Holloway, May 28, 2010.
38. Stress Engineering Services, Inc., Hydraulic Analysis of Macondo #252 Well Prior to Incident of April 20, 2010.
39. Transocean Investigation Team Interview of David Young, June 1, 2010; Transocean Investigation Team Interview of Caleb Holloway, May 28, 2010.
40. Sperry Drilling Services data logs (drilling parameters), April 5–20, 2010.
41. *Ibid.*
42. Stress Engineering Services, Inc., Hydraulic Analysis of Macondo #252 Well Prior to Incident of April 20, 2010; Sperry Drilling Services data logs (drilling parameters), April 5–20, 2010.

3.4 Blowout Preventer (BOP)

3.4 Blowout Preventer (BOP)

This section provides a comprehensive, technical overview of the *Deepwater Horizon* blowout preventer stack (BOP), including its design, maintenance, and testing history. It also details findings from the Transocean investigation team on the actions taken by the drill crew to activate its various components during the well event. The Transocean investigation team participated in the forensic investigation directed by the U.S. Coast Guard (USCG) and Bureau of Ocean Energy Management, Regulation and Enforcement (BOEMRE) Joint Investigation Team, as carried out by Det Norske Veritas (DNV). The investigation team reviewed and relied upon the evidence that DNV has provided to date.

There are two basic types of blowout preventers (BOPs) — ram and annular — that come in a variety of styles, sizes, and pressure ratings.¹ A “BOP stack” is comprised of several individual blowout preventers serving various functions that are assembled or “stacked” together, with at least one annular BOP on top of several ram BOPs. These various BOPs can seal around the drill pipe, casing, or tubing; close over an open wellbore; or cut through the drill pipe with steel shearing blades. The *Deepwater Horizon* BOP stack included seven individual BOPs.

In normal drilling operations, primary well control is achieved by hydrostatic pressure: the weight of the drilling mud counterbalances pressure from the reservoir and prevents hydrocarbons from flowing into the wellbore. Should problems such as poor casing installation or improper mud control disrupt that balance, a well-control event may occur.

The BOP stack serves as a secondary means of well control. When a formation influx occurs during drilling, one or more BOPs are activated to seal the annulus, or wellbore, to “shut in” the well. Denser or heavier mud is then circulated into the wellbore to re-establish primary well control. Mud is pumped down the drill string, up the annulus, out the choke line at the base of the BOP stack, and then up the high-pressure lines on the riser and through the choke manifold until the downhole pressure is controlled and the influx is circulated out of the well. Once this “kill weight” mud extends from the bottom of the well to the top, the well is back in balance and has been “killed.” With the integrity of the well re-established, operations may resume.²

The primary functions of the BOP stack include:

- Confining well fluid to the wellbore³
- Providing a means to add fluid to the wellbore⁴
- Allowing controlled volumes of fluid to be withdrawn from the wellbore⁵

While performing these primary functions, the BOP stack also:

- Regulates and monitors wellbore pressure⁶
- Centralizes and hangs off (i.e., closes a set of pipe rams around the drill string and supports its weight) the drill string in the wellbore⁷
- Seals the annulus between the drill pipe and the casing to shut in the well⁸
- Prevents additional influx from the reservoir into the wellbore⁹
- Seals the well by completely closing off the wellbore if no pipe is in the hole¹⁰
- Severs the casing or the drill pipe to seal the well in emergencies (e.g., loss of station keeping/emergency disconnect)¹¹

3.4.1 The *Deepwater Horizon* BOP Stack

As deployed on the sea floor, the *Deepwater Horizon* BOP stack consisted of an upper section known as the lower marine riser package (LMRP) and a lower section known as the BOP ram stack (lower BOP stack). Combined, the two sections formed the BOP stack. See *Figures 1 and 2*.

The *Deepwater Horizon* BOP stack was manufactured and supplied by Cameron and built to American Petroleum Institute (API) Specification 16A.¹² As the operator, BP specified the number and configuration of the individual BOPs. The Transocean crew regularly performed function and pressure tests on the BOP stack in accordance with regulatory requirements. The forensic evidence from post-incident testing confirms that the *Deepwater Horizon* BOP stack was properly maintained and that no maintenance deficiency contributed to the incident. *Appendices H, I, J, and K* detail the modifications carried out, the maintenance performed, the testing performed, and the minor leaks identified before and after the incident on the *Deepwater Horizon* BOP stack.

Post-incident testing shows that the BOP stack functioned and closed; however, it was overcome by the extreme dynamic flow conditions created by the blowout.

Crew members on the bridge attempted to activate the emergency disconnect system (EDS), which is designed to close the blind shear rams (BSRs) and detach the LMRP so that the rig can move away. The explosions on the rig severed the communication link between the BOP stack and the rig, preventing surface control of the EDS.¹³ As a result, efforts to activate the EDS from the bridge were unsuccessful.¹⁴

The loss of communication with the BOP stack triggered the automatic mode function (AMF), which activated the blind shear rams. When the blind shear rams closed, a portion of the drill pipe cross section was outside of the BSR shearing blades and became trapped between the ram block faces. This prevented the BSR blocks from completely shearing the pipe, fully closing, and sealing, allowing fluids to continue to flow up the wellbore.

Deepwater Horizon LMRP Design

The *Deepwater Horizon* LMRP was comprised of the two control pods and two annular BOPs, among other components.¹⁵ The top of the LMRP contained a crossover connection (LMRP riser adapter and flex joint) from the marine drilling riser to the BOP stack. At the bottom was a hydraulically actuated connector similar to the wellhead connector that locked onto the lower BOP stack. This arrangement was designed to allow the LMRP to connect and disconnect from the lower BOP stack, remotely. Once separated from the lower BOP stack, the rig could move away if needed, while the lower BOP stack remained on the subsea wellhead to seal and protect the well. See *Figure 1*.

Annular BOP

Annular BOPs are located at the top of the BOP stack. While only one is required by regulation, two annular BOPs were installed on the *Deepwater Horizon* LMRP.¹⁶ The Cameron DL Annular BOP has a donut like rubber seal known as an “elastomeric packing element,” reinforced with steel ribs or inserts. The packing element is situated in the annular BOP housing between the head and the top of the hydraulic piston. When the piston is actuated, its upward movement forces the packing unit to constrict, sealing the annulus or open hole.¹⁷ *Figure 3* is a cutaway view of a Cameron DL Annular BOP.

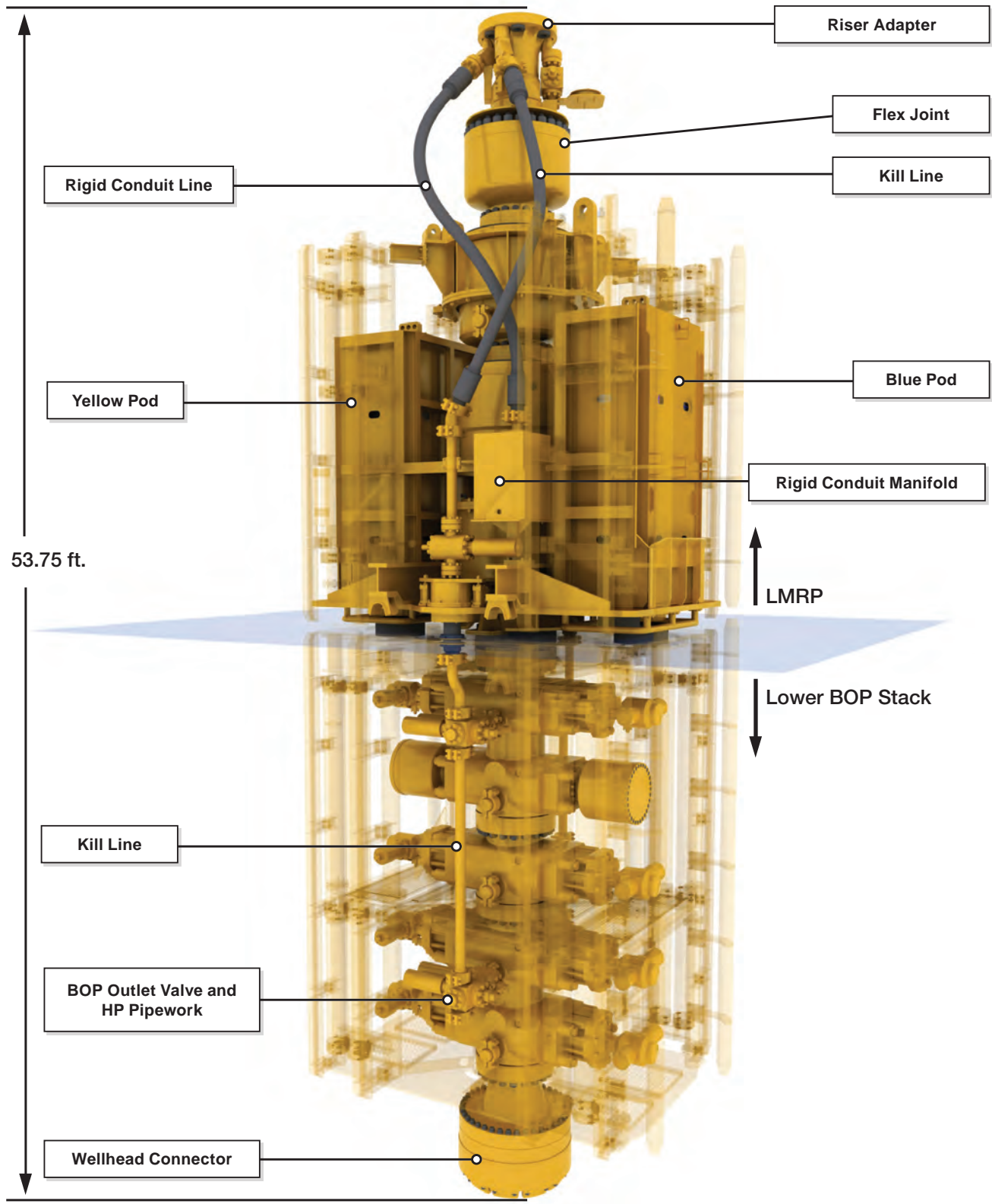

Figure 1 The *Deepwater Horizon* BOP Stack

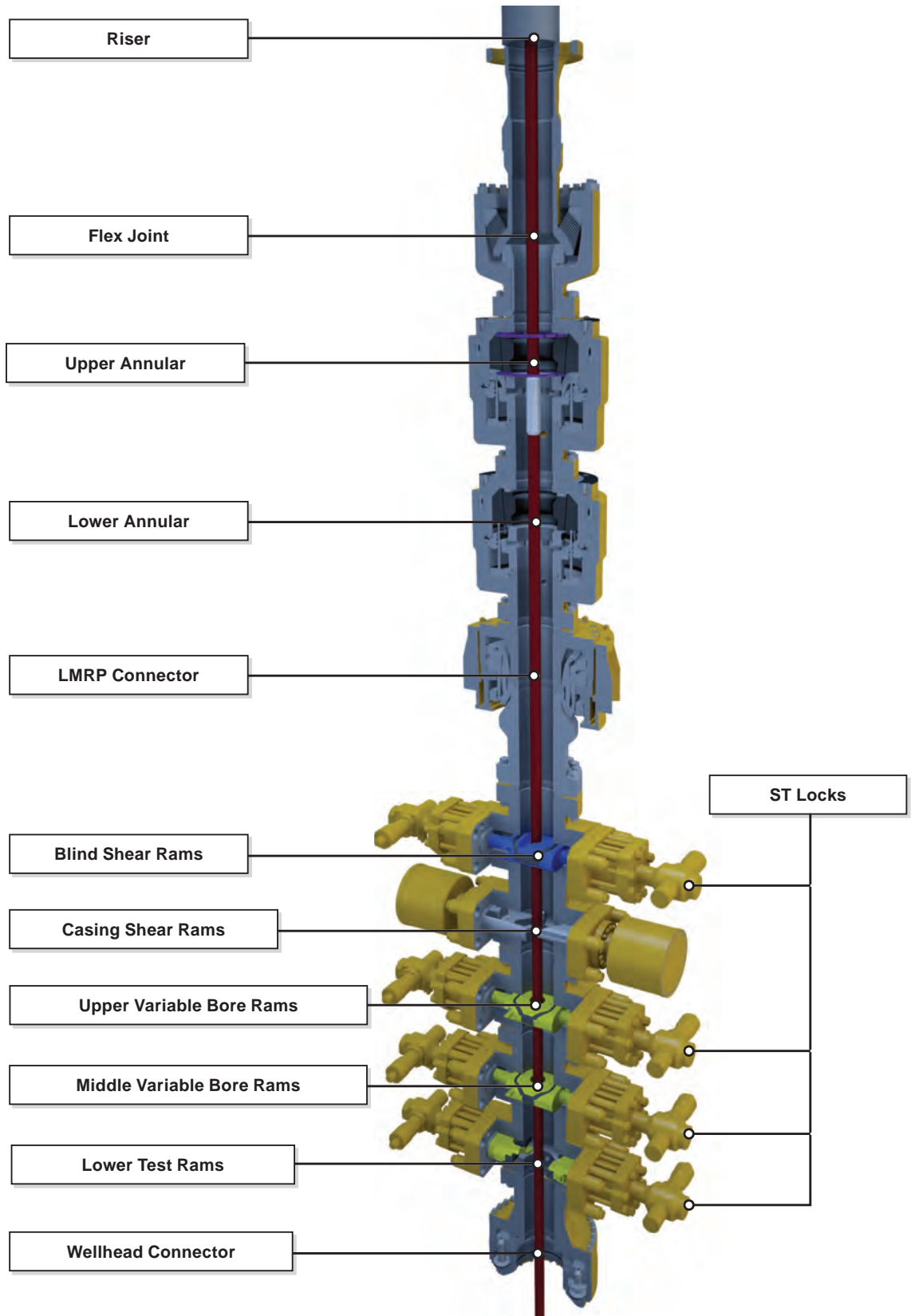

Figure 2 Cutaway View of *Deepwater Horizon* BOP Stack Components

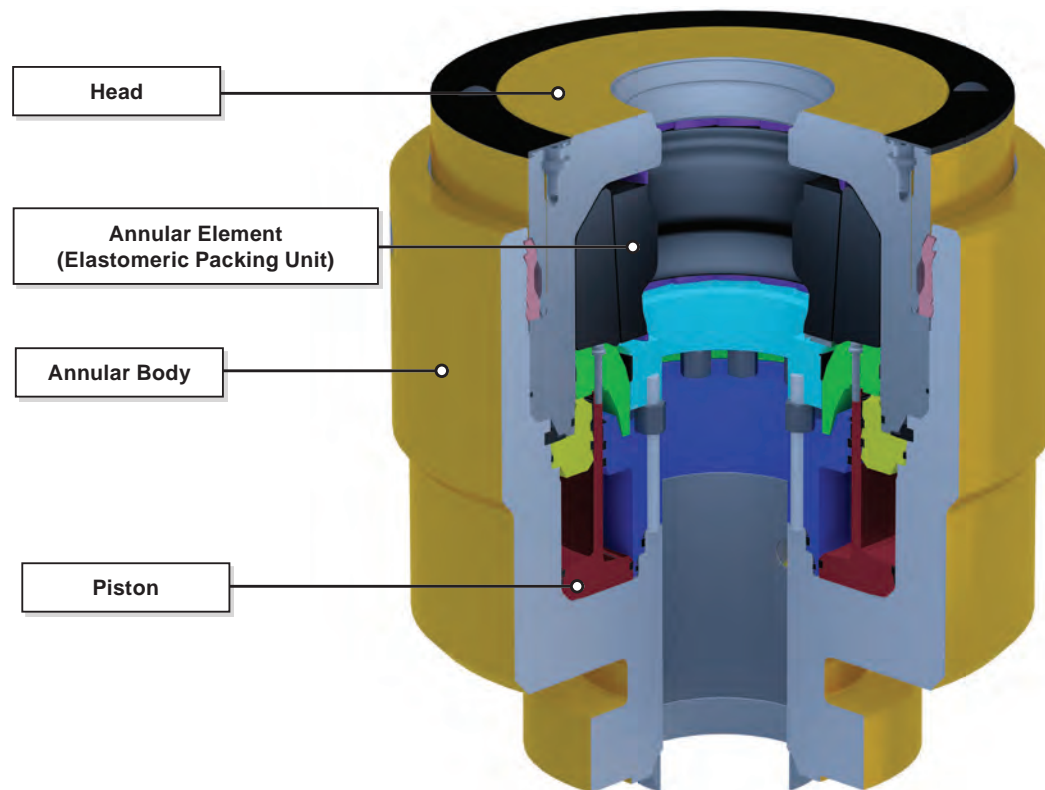

Figure 3 Typical Cameron DL Annular Blowout Preventer

Deepwater Horizon Lower BOP Stack Assembly

The lower BOP stack contains a series of ram BOPs that can be arranged in a variety of configurations depending on the operator's requirements. The operator specifies the configuration; the drilling contractor is responsible for ensuring the BOP stack meets or exceeds regulatory requirements. Additional components on the *Deepwater Horizon* lower BOP stack included choke and kill valves, a wellhead connector, and associated piping.¹⁸

The *Deepwater Horizon* lower BOP was fitted with the following components:

- One (1) Cameron Upper Ram type TL double-body BOP with ST Locks and sequence valves fitted to the upper cavity and with super shear bonnets fitted to the lower cavity:
 - **Blind shear ram:** shearing blind ram subassemblies¹⁹
 - **Casing shear ram:** super shear ram subassemblies²⁰
- One (1) Cameron Ram type TL BOP single unit with ST Locks and sequence valves:
 - **Upper pipe ram:** variable bore ram subassembly²¹
- One (1) Cameron Lower Ram type TL double-body BOP with ST Locks and sequence valves on both cavities:
 - **Middle pipe ram:** variable bore ram subassembly²²
 - **Lower pipe ram:** variable bore test ram subassembly²³
- One (1) Vetco Gray Super HD H-4 wellhead connector²⁴

Ram BOP

A ram BOP essentially is a valve that uses a pair of opposing pistons and steel ram blocks. The ram blocks extend through guide chambers (ram cavities) of the BOP housing (body) and extend (close) toward the center of the BOP wellbore to halt returning flow, or are left retracted (open) to permit flow. The inner and top faces of the ram blocks are fitted with elastomeric seals or packers that seal against the ram blocks, between each other, against the drill pipe running through the wellbore, against the ram cavity, and against the wellbore.²⁵ Outlets at the sides of the BOP body are used for connection to choke and kill valves and piping.²⁶ The three types of rams, or ram blocks, in use on the *Deepwater Horizon* at the time of the incident were variable bore pipe rams (VBRs), blind shear rams (BSRs), and casing shear rams (CSRs).²⁷

Variable Bore Pipe Rams (VBRs)

Variable bore pipe rams can close around a range of tubing and drill pipe outside diameters.²⁸ The *Deepwater Horizon* was fitted with VBRs in the third, fourth, and fifth BOP ram cavities (counting from the top), which were able to close around pipe with a diameter ranging from 3-1/2 in. to 6-5/8 in.²⁹ Figure 4 provides a detailed view of the VBRs.

At the request of BP, the VBRs in the fifth (bottom) ram cavity on the *Deepwater Horizon* were converted to test rams in 2004.³⁰ Test rams are VBRs inverted to seal pressure from above. Test rams reduce the time required to prepare for BOP pressure testing, as well as the time required to resume drilling operations afterward. By closing the test ram, the VBRs, annulars, and stack valves above can be pressure tested against the drill string and the annulus without exposing the well below the BOP to test pressure.

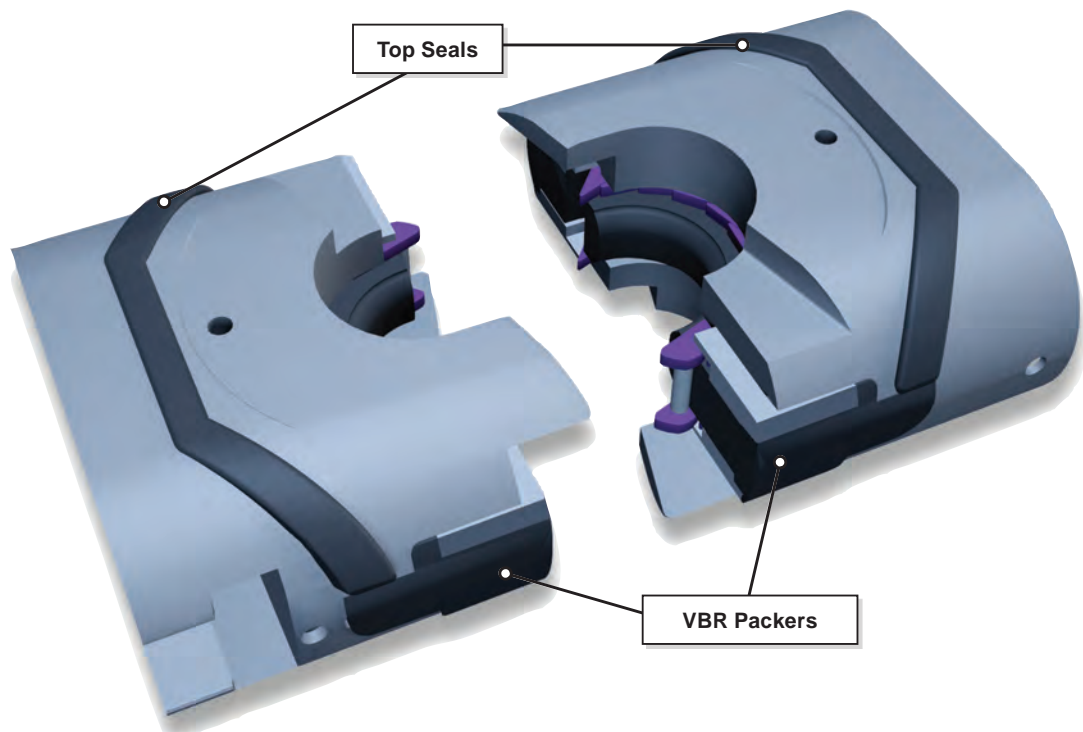

Figure 4 Typical Variable Bore Ram

Blind Shear Rams (BSRs)

Blind shear rams (also known as shearing blind rams or sealing shear rams) are designed to seal a wellbore — even when the bore is occupied by drill pipe — by cutting through the drill pipe as the rams close off and seal the well.³¹ The *Deepwater Horizon* was fitted with blind shear rams in the uppermost BOP ram cavity. *Figure 5* provides a detailed view of the blind shear rams.

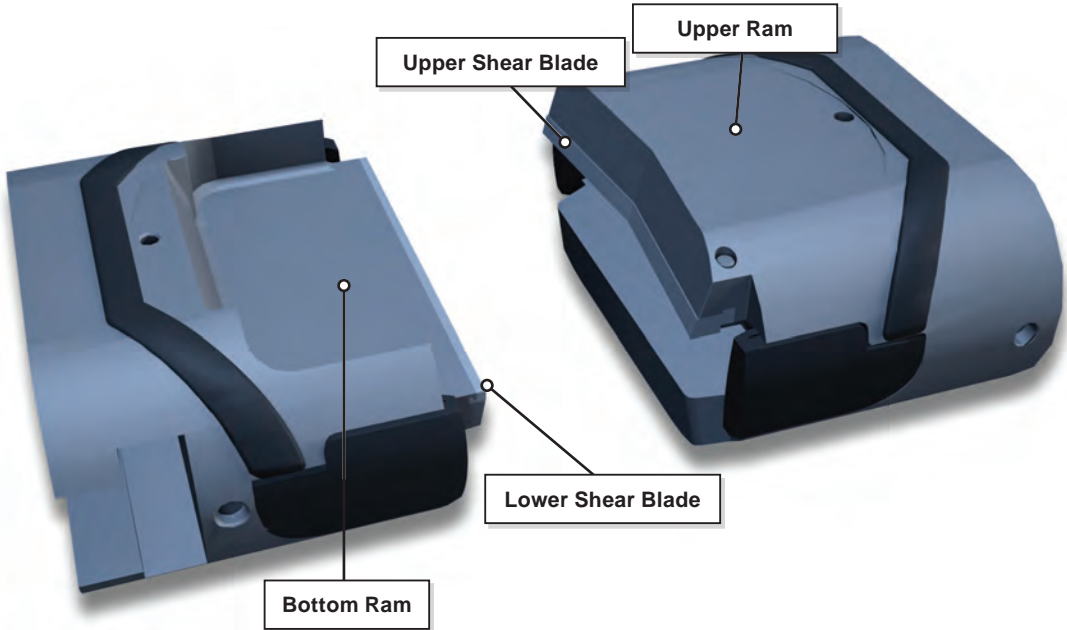

Figure 5 Typical Blind Shear Ram

Shear Rams/Casing Shear Rams

Casing shear rams (also known as super shear rams) cut through heavy wall or large diameter pipe with hardened steel shear blades but are not designed to seal the well.³² They typically are used for shearing the heaviest drill pipe and casing. The *Deepwater Horizon* was fitted with casing shear rams in the second BOP ram cavity from the top. *Figure 6* provides a view of casing shear rams.

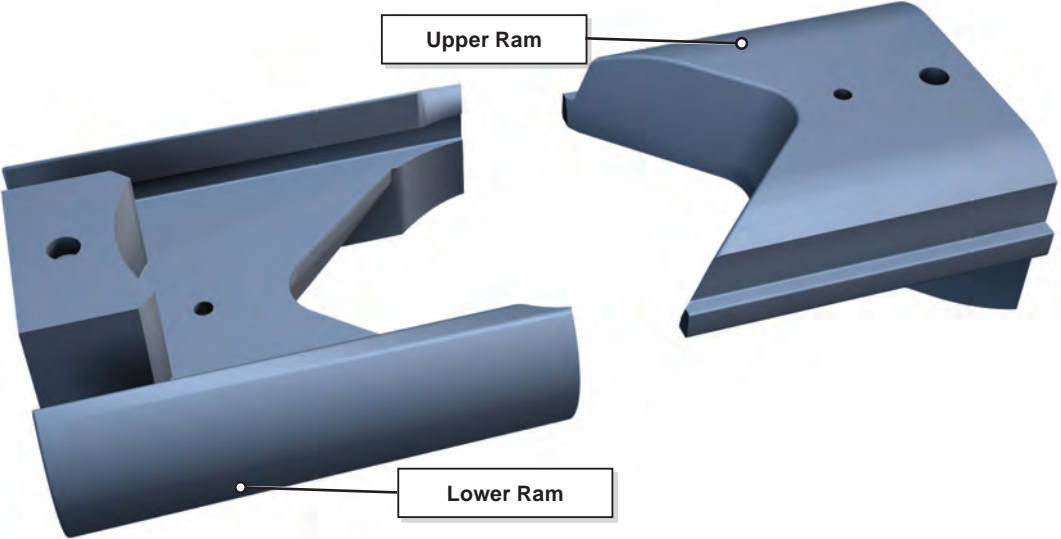

Figure 6 Typical Casing Shear Ram

Hydro-Mechanical Ram Locking Mechanism (ST Lock)

The *Deepwater Horizon* lower BOP ram stack (except for the super shear ram cavity) was fitted with hydro-mechanical ram locking mechanisms known as ST Locks.³³ When the rams move to the closed position and the ST Lock function is activated, hydraulic pressure moves the ST Lock stem and wedge assembly behind the operating piston tail rod to lock it into the closed position. To keep the stem and wedge in the locked position, the lock features an overhauling thread arrangement in which the nut rotation stops to lock the mechanism, even if hydraulic pressure is removed or lost. See Figure 7.

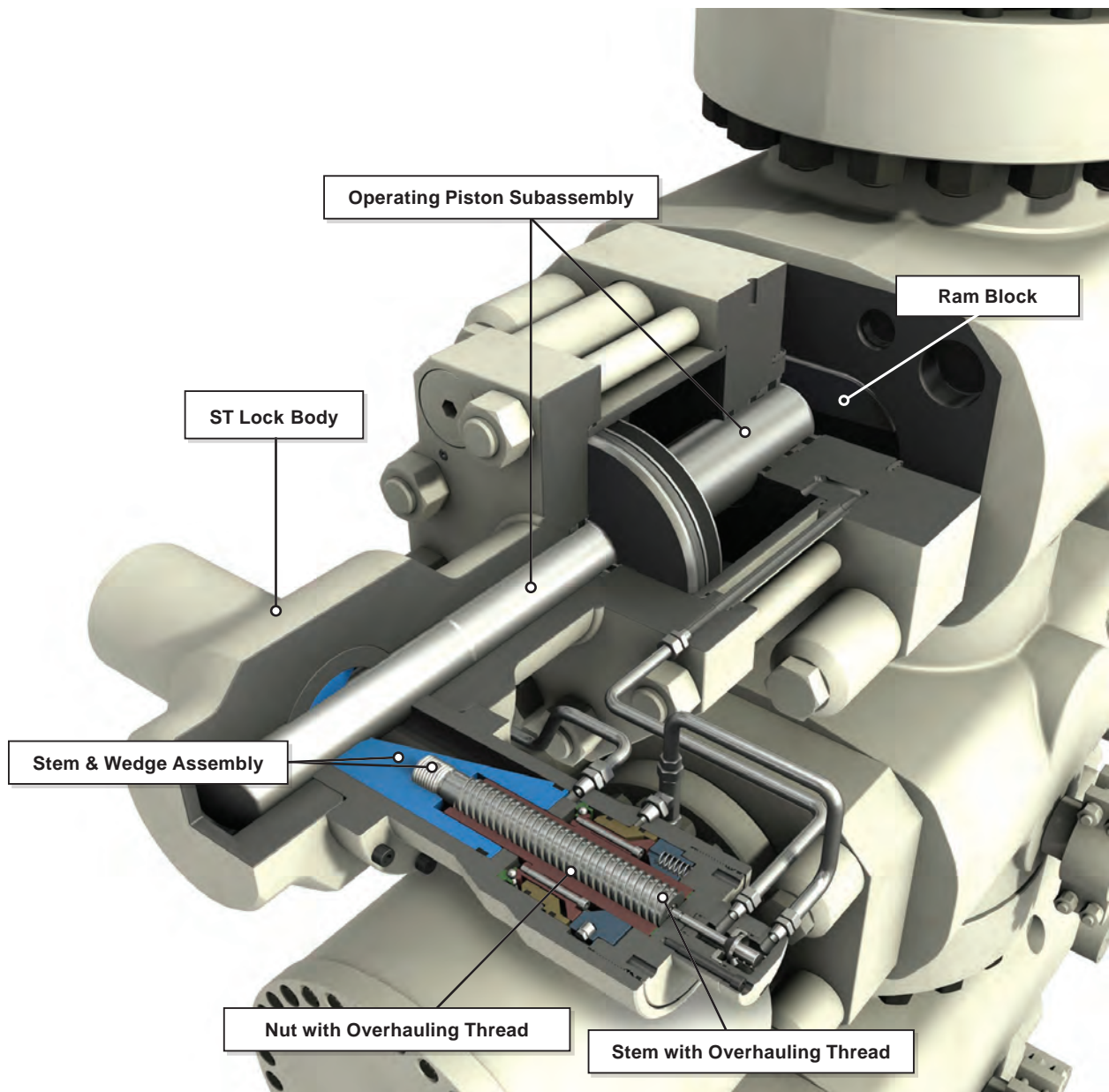

Figure 7 *Deepwater Horizon* ST Lock Arrangement in the Unlock Position

Wellhead Connector

The wellhead connector is attached at the bottom of the BOP stack and is used to lock the BOP stack onto the wellhead.³⁴ A metal gasket ensures pressure integrity between the connector and the wellhead. Because the connector is hydraulically actuated, the BOP stack can be remotely attached or released from the wellhead.

Associated Equipment *Deepwater Horizon* Diverter System

The diverter is an integral part of the mud control system, directing drilling fluids returning from the well into the mud processing system.³⁵ When required, the diverter is closed and flow from the well is directed either to the mud-gas separator (MGS) or through flow lines overboard away from the drilling rig. The *Deepwater Horizon* diverter is rated for a maximum working pressure of 500 psi³⁶ with a 14-in. diameter line to the MGS, as well as a 14-in. diameter port and starboard overboard flow lines.³⁷ See Figure 8.

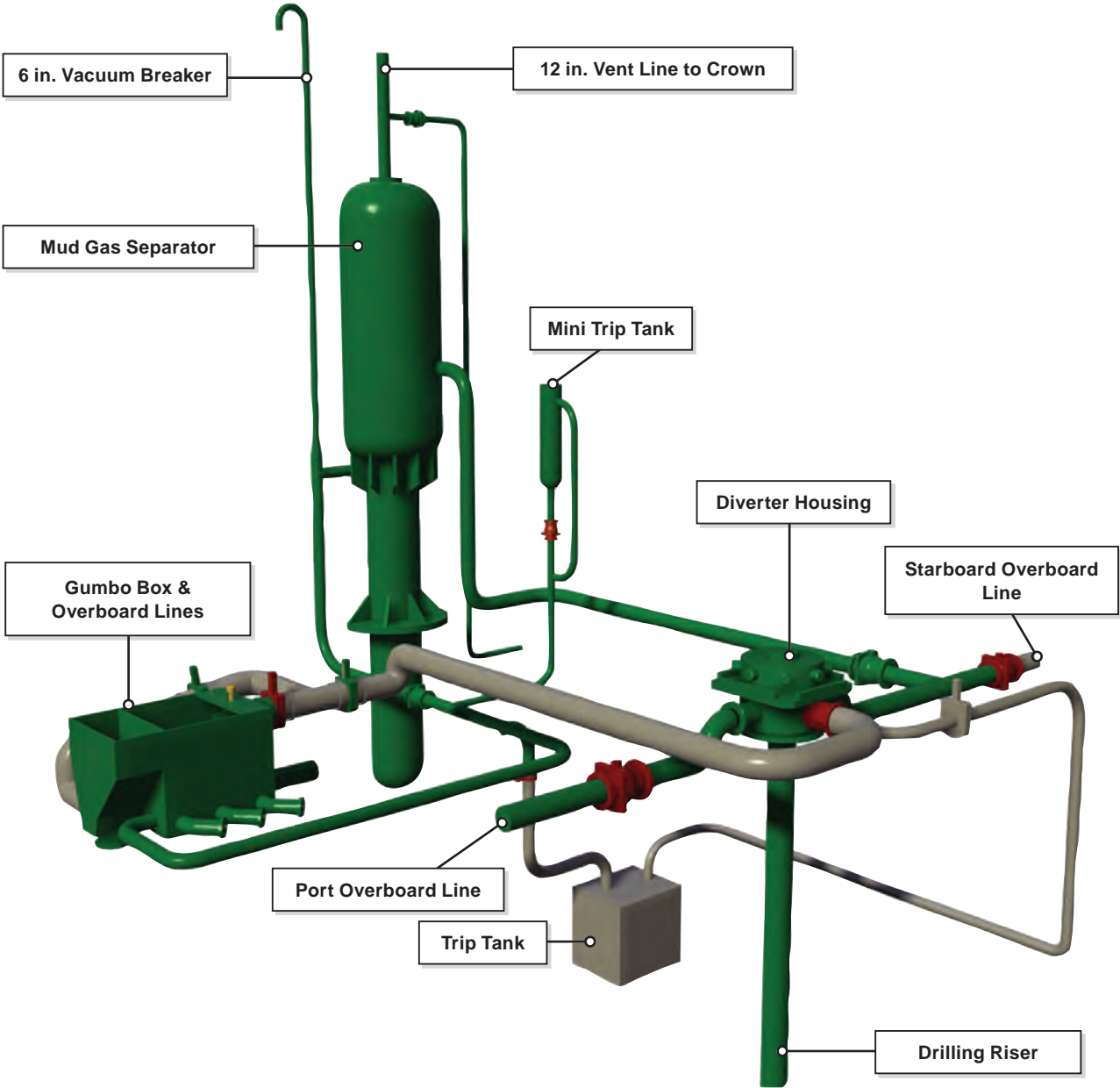

Figure 8 *Deepwater Horizon* Diverter System

Deepwater Horizon Marine Drilling Riser Tensioner System

A riser tensioning system is required to allow movement of the floating drilling rig in concert with the rising and falling of the sea. This system is attached to the marine drilling riser telescoping joint to support the marine drilling riser column with a consistent and adjustable tension.³⁸ This prevents buckling of the riser and maintains a straight column for the rotating drill pipe. The *Deepwater Horizon* riser tensioner system had six Hydralift 800,000-lb. N Line tensioners located under the drill floor.³⁹ See figure 9.

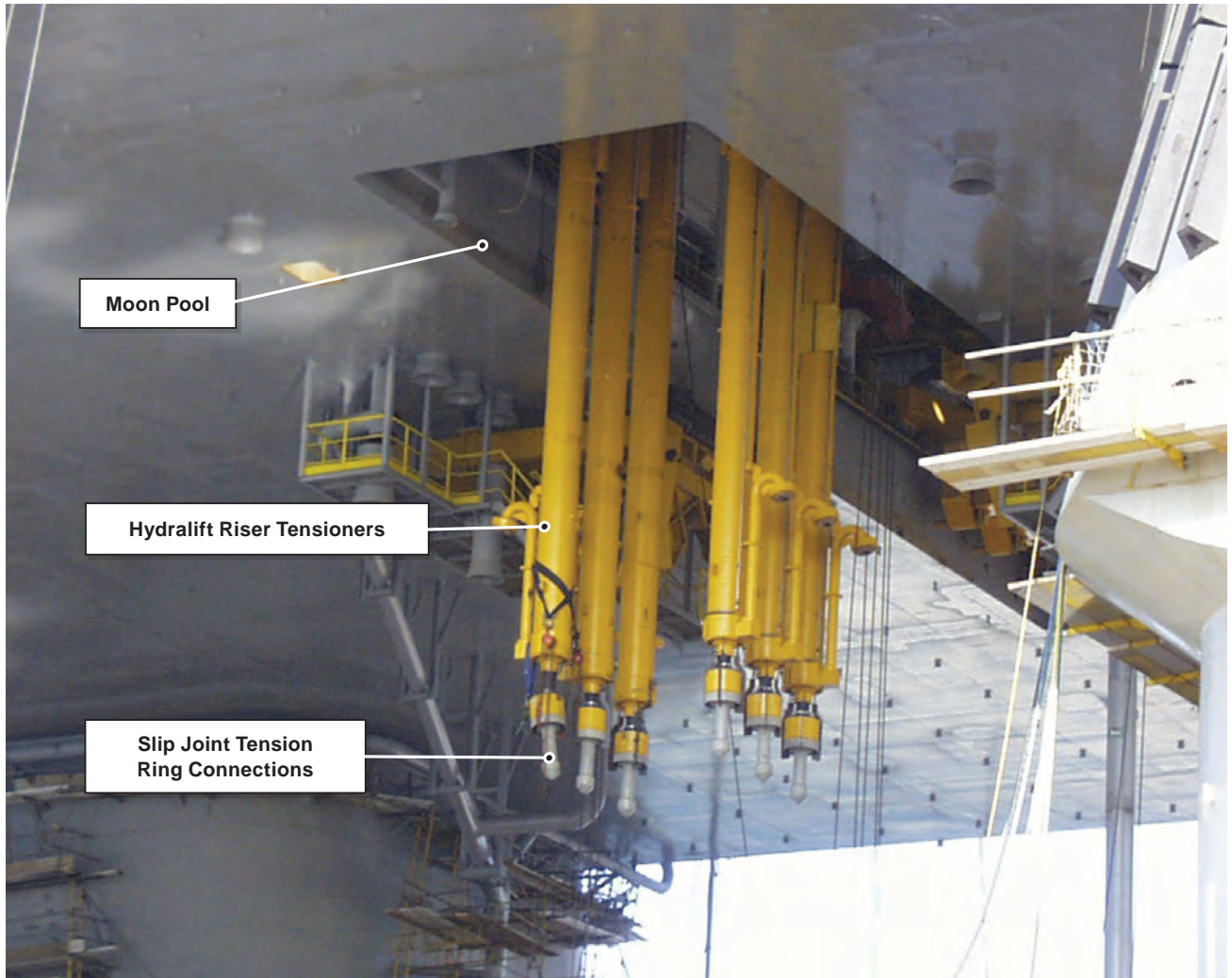

Figure 9 *Deepwater Horizon* Hydralift Riser Tensioner System

Marine Drilling Riser

The *Deepwater Horizon* marine drilling riser string, supplied by ABB Vetco Gray, was rated for 3.5 million lb. of tensile load.⁴⁰ The riser joints were 90 ft. long, and many were fitted with buoyancy modules to reduce the amount of tension required to support and maintain stability of the riser string.⁴¹ See figure 10.

Each joint contains two 15,000-psi high-pressure choke and kill lines, a stainless steel conduit line to supply the BOP control fluid and a riser “mud” boost line. The riser joint consists of a pipe body with a flanged pin on one end and a flanged box on the other, and it is joined with locking bolts that secure the flanges together.⁴²

The drilling riser becomes a low-pressure continuation of the wellbore annulus from above the BOP stack, and the drill pipe is routed through the marine drilling riser and the BOP stack.



Figure 10 Deepwater Horizon ABB Vetco Gray Riser with Buoyancy Modules

BOP MUX Control System and Secondary Systems

The *Deepwater Horizon* BOP had one primary and four secondary methods of controlling the subsea BOP stack.

Primary

The primary means of operating the BOP was the electro-hydraulic/multiplex control system (MUX). The MUX control system transmits electrical command signals to operate functions on the BOP. Commands from the surface control panels are sent through cables to two subsea control pods located on the LMRP. The signals are processed by the electronics located in the pods and converted to hydraulic signals that operate control valves directing operating fluid to the BOP stack.⁴³ Each control pod contains an assembly with two subsea electronic modules (SEMs), two subsea transducer modules (STMs), pressure regulators, solenoid valves, subsea hydraulic accumulators, and operating valves.⁴⁴ The STMs monitor the hydraulic control system pressures and the hydrostatic pressure acting on the BOP.⁴⁵

Secondary

The four secondary means of BOP control included:

- The emergency disconnect system (EDS)
- The remotely operated vehicle (ROV) intervention panels
- The auto-shear function
- The automatic mode function (AMF)⁴⁶

Emergency Disconnect System

The emergency disconnect system (EDS) is managed by the surface MUX control system. A single-button activation initiates a pre-defined sequence of functions on the BOP stack to secure the well and disconnect the LMRP.⁴⁷ EDS is most frequently used to avoid damage to the BOP and wellhead if a dynamically positioned rig unexpectedly moves off location.⁴⁸

ROV Intervention Panels

The ROV intervention panel on the lower BOP stack provides a direct input for an ROV to apply hydraulic pressure to five predetermined functions on the BOP (wellhead connector – unlock; upper blind shear rams – close; lower pipe rams – close; wellhead connector gasket – release; and wellhead connector – flush).⁴⁹

The ROV intervention panel on the LMRP provides a direct input for an ROV to apply hydraulic pressure to four predetermined functions on the LMRP (LMRP connector – unlock; choke and kill connectors – unlock; LMRP accumulator – dump; and LMRP connector ring gasket – release).

Auto-shear Function

The auto-shear mechanically activates the high-pressure shear circuit to close the blind shear rams and ST Locks if the LMRP is unexpectedly disconnected from the BOP stack.⁵⁰

Automatic Mode Function

The automatic mode function (AMF) is an emergency backup located in the subsea control pods that activates the high-pressure shear circuit to close the blind shear rams and ST Locks if hydraulic pressure and electric power are lost to the BOP stack (e.g., in the case of riser failure).⁵¹

The AMF consists of a custom-printed circuit board supplied by Cameron, which is dedicated to the AMF function. Major components associated with the AMF system include the following:

- Two subsea electronic modules (SEM A and SEM B) are located in each of the pods for a total of four SEMs on the BOP stack.^A
- AMF cards (one per SEM, two per pod, and four in the BOP system)
- A dedicated 9-volt (V) DC battery pack per AMF card (one per SEM, two per pod, and four in the BOP system)
- 27V DC battery pack shared for both SEM A and B (one per pod and two in the BOP system)
- Solenoid 103 is energized to activate the high-pressure shear circuit for 30 seconds when the AMF is activated
- Dedicated subsea hydraulic accumulators to operate the functions commanded by the AMF system^{52, B}

3.4.2 Condition of the *Deepwater Horizon* BOP Stack

To determine the condition of the *Deepwater Horizon* BOP stack at the time of the incident, the investigation team reviewed data including but not limited to:

- The history of modifications implemented over the life of the BOP
- The maintenance history
- Leaks that were identified before and after the incident
- The test history of the BOP while on the Macondo well
- Applicable engineering bulletins, product advisories, and product alerts
- Interviews with Transocean maintenance personnel
- Data gathered following other post-incident response activities

Modifications

After the *Deepwater Horizon* BOP stack was commissioned in 2001 and went into service, a total of 20 modifications were made to improve operability and reliability based on recommendations by Transocean, BP, and/or Cameron. The investigation team concluded that none of the modifications adversely impacted the operation of the BOP at the time of the incident. A detailed review of the modifications may be found in *Appendix H*.

Cameron and Transocean websites were consulted for engineering bulletins, product advisories, and product alerts concerning the BOP equipment, of which a total of 314 were identified. Of these, 73 had been completed, 113 did not apply to the *Deepwater Horizon*, and 127 were for information purposes only. While the status of

A When functions are activated from surface controls, the signal is sent to the SEMs to carry out the command by energizing the respective solenoid valves. The solenoid valves have two operating coils individually connected to one of the two SEMs in the pod so that either SEM can operate the valve.

B Eight each – 80-gallon accumulators, 6,000 psi working pressure

one advisory could not be determined, it was found that this advisory did not have an effect on the operation of the BOP on April 20, 2010.

Maintenance

Transocean's conditioned-based maintenance philosophy is designed to:

- Ensure the integrity of safety, environmental, and operations equipment to deliver the required performance and reliability throughout the asset's life cycle
- Preserve the installations, facilities, equipment, machinery, and structures to maximize the useful working life of assets in a cost-effective manner
- Manage maintenance activities using standardized processes, focusing on critical equipment, and planning the work to ensure that it is carried out in a timely manner
- Ensure maintenance activities are completed by competent equipment owners and maintenance personnel
- Minimize non-productive operating time through proper planning, execution, evaluation and continuous improvements to the maintenance system

The *Deepwater Horizon* BOP was operated in accordance with the maintenance requirements of the Transocean Subsea Maintenance Philosophy document.⁵³ This document outlines the type and timing of maintenance to be performed, including preventive and corrective maintenance, component condition evaluation, function and pressure testing, and major overhauls.

The investigation team reviewed the Transocean maintenance management system and identified 752 tasks for the BOP and subsea equipment to be performed during the preceding 365-day period. On April 20, 2010, only four of 752 tasks were overdue. These tasks were related to the following equipment: (1) BOP pipe ram cavities, (2) BOP stack LMRP connector, (3) choke control unit on the drill floor, and (4) surface choke and kill piping. These maintenance tasks are briefly summarized below, and a detailed review can be found in *Appendix I*.

1. The annual maintenance to be performed on the ram blocks (including the piston end, the hydraulic bonnet studs, and the operating BOP body threads) required non-destructive testing (NDT), inspection, and service of the ram blocks over a 365 day interval; this was due to commence in January 2010.⁵⁴ This work can only be carried out while the BOP is at the surface and would have been completed during the between-well maintenance at the end of the Macondo well. The independent forensic analysis performed by DNV confirmed that the BOP pipe rams closed during the response to the well-control incident, and this outstanding maintenance task did not adversely affect the operation of the BOP.⁵⁵
2. The maintenance task requiring surface testing and operation of the LMRP connector to determine connector wear is performed at 180 day intervals and was due to be performed on March 30, 2010. This work can only be carried out while the BOP is at the surface and would have been completed during the between-well maintenance after the rig left the Macondo well.⁵⁶ During the course of operations at the well, the BOP stack was pressure tested at regular intervals, and those tests confirmed the integrity of the connector. See *Appendix J*. The LMRP connector did not contribute to the incident.
3. BOP choke control maintenance is performed at seven-day intervals and was scheduled to be completed on April 16, 2010.⁵⁷ The BOP choke control unit was not used during the incident and had no affect on the well control response.
4. High-pressure choke and kill piping from the choke manifold to the moon pool required inspection and service at 30 day intervals. This planned maintenance procedure had been performed on March 19, 2010, and was scheduled for April 18, 2010.⁵⁸ The BOP choke and kill piping had been inspected and used successfully before the incident and did not contribute to the incident.

As noted, none of the outstanding maintenance tasks adversely affected the operation of the BOP during the well-control response. Routine operation and testing of the BOP prior to the incident, post-incident intervention and recovery, and investigations to date have confirmed that the identified items and the BOP were operating satisfactorily.

Minor Leaks

Five minor leaks were identified in the *Deepwater Horizon* BOP control system: three identified and assessed pre-incident and two identified during the post-incident ROV intervention. A detailed review of the five minor leaks, which had no adverse impact on the functionality of the BOP, may be found in *Appendix K*, and are as follows:

Identified Pre-Incident:

1. Leak on the test ram open-side function
2. Leak on the accumulator surge bottle on the upper annular BOP
3. Leak on the lower annular close function

Identified Post-Incident:

4. Leak on a hose fitting to the lock function on the ST Lock circuit.
 5. Leak on the tubing from the blind shear ram ST Lock sequence valve to the blind shear ram ST Lock chamber
1. The test ram is the lowermost ram and is used during function and pressure testing of the BOP stack; it is not used for well control and, therefore, could not have impacted the events of April 20, 2010. The Transocean subsea team reported the small volume test ram leak to BP as reflected in the BP Daily Operations Reports of Feb. 23–March 13, 2010.⁵⁹ The operation report identified the leak as being on the yellow pod, and the drill crew switched to the blue pod to stop the leak and allow further investigation.
 2. On Feb. 19, 2010, a Transocean senior subsea supervisor identified a leak in the upper annular BOP close circuit at the hose fitting to the upper annular surge bottle. The leak was detectable but very small; at a set pressure of 1,500 psi, the leak rate was determined to be 0.1 gallons per minute (gpm).⁶⁰ A leak of this size would not have adversely affected the operation of the upper annular BOP.
 3. Transocean's senior subsea engineer noted a leak in the close function of the lower annular and confirmed that it was very small and that the annular BOP would still close when needed. The flow rate of the leak was confirmed to be about 0.1 gpm. The leak appeared as a "tick," or a brief flickering indication, on the hydraulic fluid flow meter located on the BOP control panel. The flow indication appeared only when the lower annular BOP was in the closed position, and the subsea team did not identify any fluid leaking externally from the system.⁶¹ Such a leak would not and did not impede the functionality of the lower annular BOP. The lower annular BOP was used for the negative pressure test but was not used during the well-control incident.
 4. During the post-incident response efforts, when the ROV operated the pipe ram function on the ROV intervention panel, the intervention team noted a leak on the lock function on the ST Lock circuit for the BOP rams. The team used an ROV to retighten the hose fitting.⁶² This leak did not prevent the ST Locks from operating and would not have impacted the well-control response.
 5. Transocean identified a leak on April 26, 2010, in the tubing connection that runs from the blind shear ram ST Lock sequence valve to the ST Lock chamber.⁶³ The leak was not apparent until the pressure on the ST Lock was above 4,000 psi. The BOP ram must be approximately 90% closed for a sequence valve to open, allowing fluid to pass through to the ST Lock locking function and creating the conditions for a leak in this location. The existence of this leak confirmed that the shear ram on this bonnet was closed. Further, based on the ROV video, this leak was small and would not have prevented the ST Lock from functioning.⁶⁴

The five leaks identified above had no adverse impact on the functionality of the BOP. The leaks were small in volume and would not have impacted the closing or sealing capabilities of the BOP stack.

Testing

The BOP stack is regularly maintained and pressure tested.⁶⁵ Tests include function tests every seven days and comprehensive pressure tests every 14 days. Testing is performed to verify the pressure containment capability of the various BOPs and to identify any malfunctions that may require the BOP stack to be retrieved and repaired.

See *Table 1* for a complete list of all tests performed on the BOP while on the Macondo location. The BOP passed each of these tests. See also *Appendix J*.

Test Conducted	Test Date	References
Function Test Both Pods (Surface Pre-run)	February 5, 2010	Daily Drilling Report, February 5, 2010 (TRN-HCJ-00076220)
Pressure Test BOP (Surface Pre-run)	February 6, 2010	Daily Drilling Report, February 6, 2010 (TRN-HCJ-00076224)
Function Test Diverter	February 9, 2010	Daily Drilling Report, February 9, 2010 (BP-HZN-BLY00101577)
Pressure Test BOP	February 9, 2010	Daily Drilling Report, February 9, 2010 (BP-HZN-BLY00101577)
Pressure Test BOP	February 10, 2010	Daily Drilling Report, February 10, 2010 (TRN-HCJ-00076236)
Function Test BOP	February 10, 2010	Daily Drilling Report, February 10, 2010 (TRN-HCJ-00076236)
Well Casing Integrity Test	February 10, 2010	Daily Drilling Report, February 10, 2010 (TRN-HCJ-00076236)
Pressure Test Upper Annular	February 12, 200	Daily Drilling Report, February 12, 2010 (DOC-00000162)
Function Test BOP	February 17, 2010	Daily Drilling Report, February 17, 2010 (TRN-HCJ-00076240)
Function Test Diverter	February 17, 2010	Daily Drilling Report, February 17, 2010 (TRN-HCJ-00076240)
Pressure Test BOP	February 24, 2010	Daily Drilling Report, February 24, 2010 (TRN-HCJ-00076256)
Pressure Test BOP	February 25, 2010	Daily Drilling Report, February 25, 2010 (TRN-HCJ-00076260)
Function Test BOP	February 25, 2010	Daily Drilling Report, February 25, 2010 (TRN-HCJ-00076260)
Function Test Diverter	February 25, 2010	Daily Drilling Report, February 25, 2010 (TRN-HCJ-00076260)
Casing Integrity Test	March 1, 2010	Daily Drilling Report, March 1, 2010 (BP-HZN-BLY00047076)

Table 1 Testing Performed on the BOP while on the Macondo Location

Test Conducted	Test Date	References
Function Test BOP	March 4, 2010	Daily Drilling Report, March 4, 2010 (TRN-HCJ-00076264)
Function Test Diverter	March 4, 2010	Daily Drilling Report, March 4, 2010 (TRN-HCJ-00076264)
MMS BOP Test Extension	March 12, 2010	Daily Drilling Report, March 12, 2010 (BP-HZN-CEC019117)
MMS BOP Test Extension	March 13, 2010	Daily Drilling Report, March 13, 2010 (DOC-00000191)
Pressure Test BOP	March 15, 2010	Daily Drilling Report, March 15, 2010 (TRN-MDL-00011448)
Function Test BOP	March 15, 2010	Daily Drilling Report, March 15, 2010 (TRN-MDL-00011448)
Function Test Blind Shear Rams	March 21, 2010	Daily Drilling Report, March 21, 2010 (TRN-MDL-00026217)
Pressure Test Blind Shear Rams	March 21, 2010	Daily Drilling Report, March 21, 2010 (TRN-MDL-00026217)
Function Test BOP	March 22, 2010	Daily Drilling Report, March 22, 2010 (TRN-OIG-00154567)
Pressure Test Blind Shear Rams	March 26, 2010	Daily Drilling Report, March 26, 2010 (TRN-HCJ-00076276)
Function Test Blind Shear Rams	March 26, 2010	Daily Drilling Report, March 26, 2010 (TRN-HCJ-00076276)
Casing Integrity Test	March 26, 2010	Daily Drilling Report, March 26, 2010 (TRN-HCJ-00076276)
Function Test BOP	March 27, 2010	Daily Drilling Report, March 27, 2010 (TRN-HCJ-00076280)
Pressure Test BOP	March 27, 2010	Daily Drilling Report, March 27, 2010 (TRN-HCJ-00076280)
Test Diverter	March 31, 2010	Daily Drilling Report, March 31, 2010 (TRN-HCJ-00090932)
Pressure Test Blind Shear Rams	April 1, 2010	Daily Drilling Report, April 1, 2010 (TRN-HCJ-00090935)
Casing Integrity Test	April 1, 2010	Daily Drilling Report, April 1, 2010 (TRN-HCJ-00090935)
Function Test BOP	April 3, 2010	Daily Drilling Report, April 3, 2010 (DOC-00000212)

Table 1 (cont'd)

Test Conducted	Test Date	References
Function Test Diverter	April 3, 2010	Daily Drilling Report, April 3, 2010 (DOC-00000212)
Pressure Test Blind Shear Rams	April 8, 2010	Daily Drilling Report, April 8, 2010 (TRN-HCJ-00090959)
Function Test Blind Shear Rams	April 8, 2010	Daily Drilling Report, April 8, 2010
Pressure Test BOP	April 9, 2010	Daily Drilling Report, April 9, 2010 (TRN-OIG-00154585)
Pressure Test BOP	April 10, 2010	Daily Drilling Report, April 10, 2010 (TRN-OIG-00154589)
Function Test BOP	April 10, 2010	Daily Drilling Report, April 10, 2010 (TRN-OIG-00154589)
Function Test Diverter	April 10, 2010	Daily Drilling Report, April 10, 2010 (TRN-OIG-00154589)
Function Test BOP	April 17, 2010	Daily Drilling Report, April 17, 2010 (TRN-HCEC-00065051)
Function Test Diverter	April 17, 2010	Daily Drilling Report, April 17, 2010 (TRN-HCEC-00065051)
Function Test Blind Shear Rams	April 17, 2010	Daily Drilling Report, April 17, 2010 (TRN-HCEC-00065051)
Function Test Diverter	April 19, 2010	Daily Drilling Report, April 19, 2010 (TRN-MDL-00011512)
Casing Integrity Test	April 20, 2010	Daily Drilling Report, April 20, 2010 (TRN-MDL-00011518)
Pressure Test Blind Shear Rams	April 20, 2010	Daily Drilling Report, April 20, 2010 (TRN-MDL-00011518)

Table 1 (cont'd)

Conclusions on the Condition of the *Deepwater Horizon* BOP

The BOP stack and BOP control systems were maintained in accordance with the company maintenance management system. The modifications to the BOP stack, identified in *Appendix H*, maintained or improved performance. The leaks identified prior to the incident did not adversely impact the functionality of the BOP stack. The BOP stack was fully operational, and there were no known maintenance deficiencies on April 20, 2010, that would have adversely impacted the BOP stack.

3.4.3 BOP Activation

When flow in the well was detected at approximately 9:42 p.m., the drill crew took the following actions:

- Closed the upper annular BOP element⁶⁶
- Alerted BP and Transocean personnel onboard the rig
- Closed the diverter packer (seal within the diverter housing just below the rig floor) and diverted the flow to the MGS⁶⁷
- Closed the upper and middle variable bore rams (VBRs) at approximately 9:47 p.m.⁶⁸

Upper Annular BOP Closed

Prior to displacement operations, it is typical for the driller to locate and position the drill pipe tool joint^C in the BOP, to ensure that a continuous length of drill pipe of uniform diameter runs through the rams, allowing the rams to properly close around the drill pipe and not on the larger diameter tool joint, for which they are not designed.⁶⁹

At the time of the incident on April 20, 2010, the extreme flow rate from the well created sufficient force to lift the drill string, moving the tool joint up and partly into the upper annular BOP element.⁷⁰ This position of the tool joint was confirmed from the pipe sections recovered with the riser joint at the NASA Michoud facility. The analysis compared the distance between the BOP rams and annulars to the drill pipe from the BOP stack and riser, along with markings on the drill pipe. See Appendix L.⁷¹

FLOW RATE IN CONTEXT

- When the annular closed at approximately 9:43 p.m., the flow rate from the well at the BOP was approximately 100 barrels per minute (bpm).
- A typical flow rate for a kick is 10–15 bpm.
- 1 bbl is equal to 42 gallons, and a typical residential swimming pool is roughly 10,000 to 20,000 gallons.
- Thus, a flow rate of 100 bpm would fill a typical backyard swimming pool every 2.5–5 minutes.

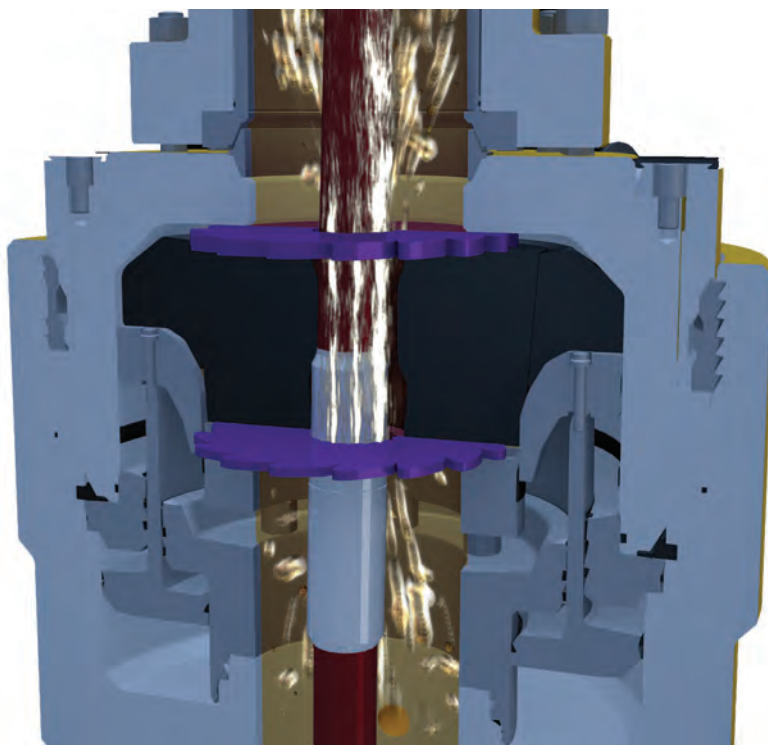

Figure 11 Drill Pipe Tool Joint Lifted by Flow into Upper Annular

C A tool joint is where two sections of pipe are threaded together, resulting in a larger diameter segment.

Figure 11 shows the drill pipe tool joint in the upper annular BOP element stack as a result of the upward force from the flowing well.

At approximately 9:41 p.m., the drill crew directed flow to the trip tank to monitor the well and observed a rising fluid level in the tank.⁷² The drill crew activated the upper annular BOP from the drill floor at approximately 9:43 p.m.⁷³ During the 26 seconds required for the annular BOP to fully close,⁷⁴ hydrocarbons and well debris flowed with increasing velocity between the rubber annular BOP packing element and the drill pipe tool joint. This flow eroded both components, carving a flow path for hydrocarbons through the annular BOP packing element and into the riser.

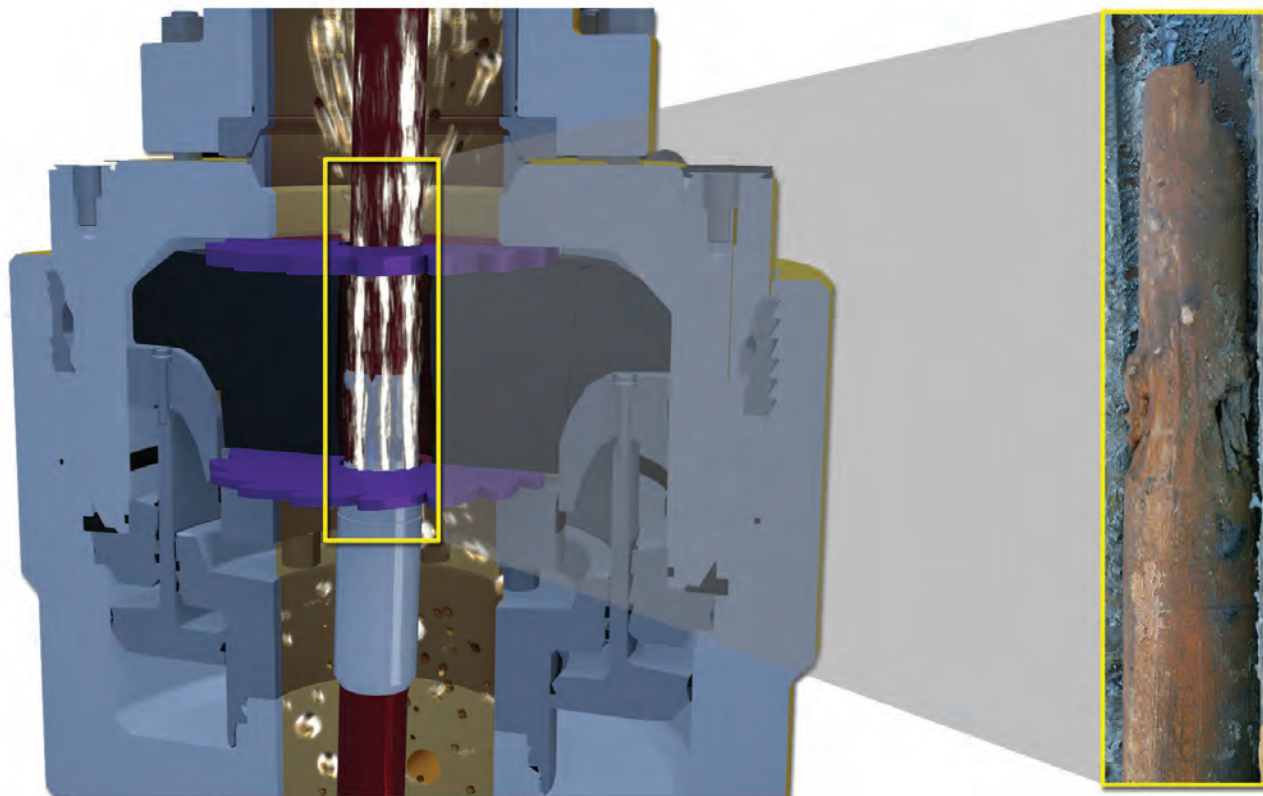

Figure 12 Drill Pipe Erosion

Figure 12 depicts the erosion of the drill pipe and annular BOP during the initial attempt to shut in the well and shows the eroded drill pipe recovered from the *Deepwater Horizon* riser at the NASA Michoud facility. The distance between the upper and lower fingers of the annular element is 18 in., which corresponds to the section of drill pipe shown in the figure.⁷⁵ The contact with the lower fingers can be clearly identified on the tool joint. The erosion on the upper section of the drill pipe aligns with the area of the upper fingers of the annular element.

Diverter Packer Closed

The gas expanded as it moved up the riser, pushing mud onto the drill floor.⁷⁶ The drill crew closed the diverter packer to redirect the flow from the well to the MGS pursuant to BP and Transocean standard practice.⁷⁷ As the flow from the well increased due to the rapid expansion of gas in the riser, the flow rate exceeded the capacity of the MGS.⁷⁸ At approximately 9:48 p.m.,⁷⁹ witnesses said mud began flowing out of the MGS vacuum breaker line located halfway up the derrick, and fluid overflow from the MGS filled the mini trip tank.⁸⁰ See *Figure 13*.

Variable Bore Rams Closed

Although the drill crew had closed the upper annular BOP, hydrocarbons continued to flow through the washed-out rubber packing element and around the eroded drill pipe. The drill crew then closed the upper and middle VBRs at approximately 9:47 p.m. The closing of the VBRs stopped the flow through the annulus and caused pressure inside the drill pipe to increase to 5,750 psi at the surface at approximately 9:49 p.m., as recorded on the last transmission of real-time data.^{81, D}

Additional evidence confirming closure of middle and upper ram BOPs by the driller includes:

Upper VBRs

- No ROV intervention occurred to the upper VBRs post incident, which indicates the upper VBRs had been closed by the drill crew prior to the post-incident ROV intervention.⁸²
- Radiographic surveys were completed by May 15, 2010, and indicated that the rams were closed and the ST Locks were locked.⁸³
- When the yellow pod was re-deployed from the Q4000 oilfield service vessel and the upper VBRs close function was activated on May 26, 2010, the flow count was 0.4 gallons, confirming that the VBRs were closed. (Normal close volume is approximately 24 gallons.) This process was repeated a second time to confirm.⁸⁴
- The upper VBRs were found closed during a video camera inspection of the BOP on board the Q4000 on Sept. 9, 2010.⁸⁵

Middle VBRs

- ROV intervention on May 5, 2010, cut the blue pod middle VBR close hose to the shuttle valve, installed an ROV connection, and pressured the function with a subsea accumulator bank.⁸⁶ The middle VBRs pressured up immediately to 3,500 psi with no indication of flow, confirming the rams were closed previously by the drill crew.
- Radiographic surveys were completed by May 15, 2010, and indicated that the rams were closed and that the ST Locks were locked.⁸⁷
- The middle VBRs were found closed during the BOP forensic inspection at NASA Michoud.⁸⁸

D The kill line was lined up with the BOP upper kill valves open to the wellbore. When the upper VBRs were closed, the kill line was isolated from the well. At approximately 9:47 p.m., pressure in the kill line dropped rapidly and the pressure in the drill pipe increased rapidly, indicating that the VBRs were closed

Figure 13 illustrates the path of return flow to the MGS after the diverter was closed.

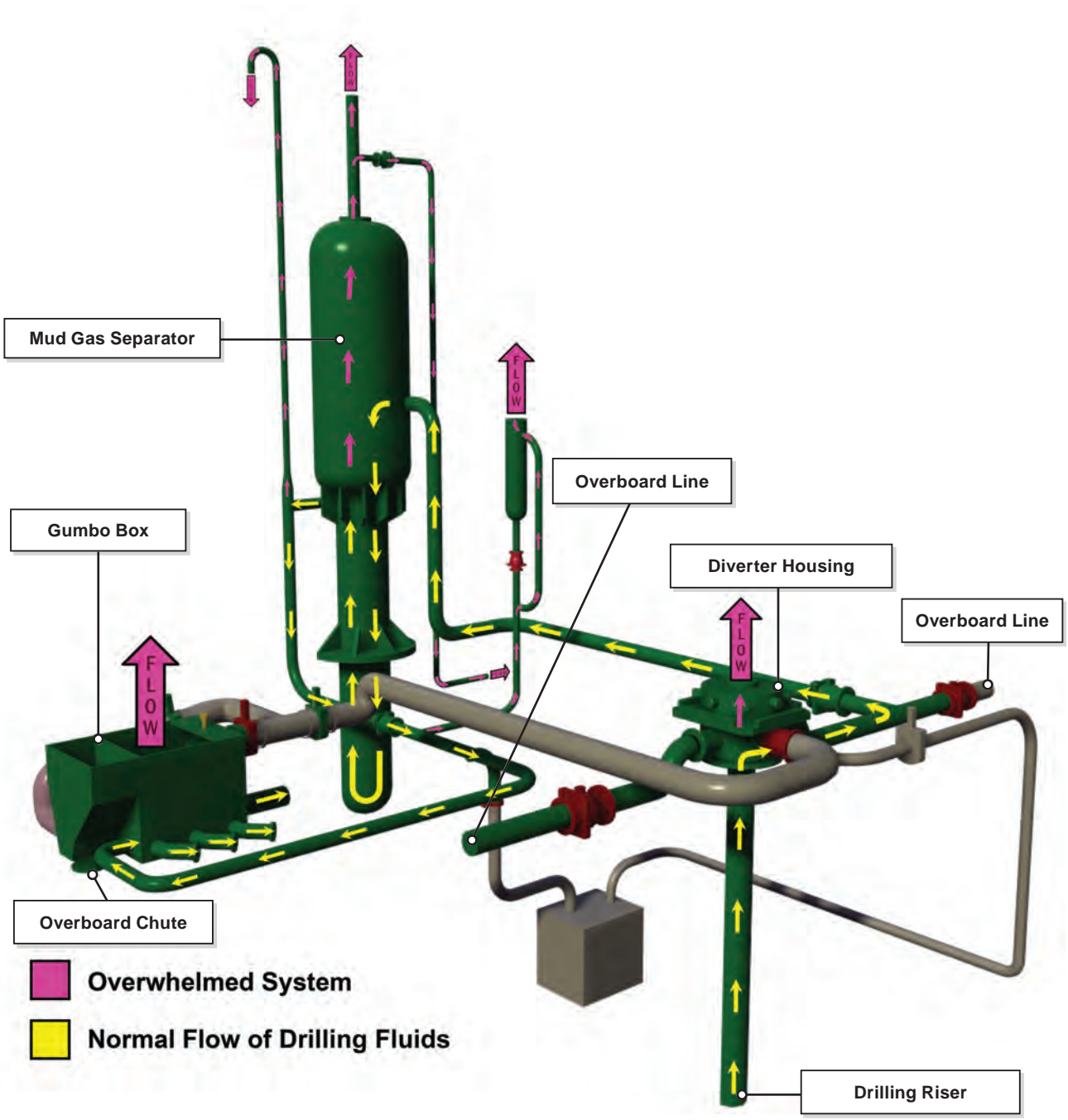

Figure 13 Path of Return Flow after Diverter was Closed and then Overcome

Drill Pipe Bows in the BOP

Once the variable bore rams (VBRs) were closed, the shut-in well pressure below the rams increased to more than 7,000 psi, and the force of the pressure pushing upward on the drill pipe exceeded 150,000 lb.^{89, E} The drill pipe tool joint was restrained by the upper annular BOP packing element as well pressure forced the drill pipe upward, bowing the drill pipe in the BOP bore between the upper VBRs and the upper annular packing element.⁹⁰

The rig lost power at 9:49 p.m., followed by explosions and fires resulting in a loss of station keeping ability.⁹¹ As the *Deepwater Horizon* drifted off location, the drill pipe was pulled between the traveling block on the rig floor and the BOP stack. At the BOP stack, the internal drill pipe pressure at the upper annular continued to climb above 8,000 psi.^F Within minutes, the forces ruptured the drill pipe above the upper annular where the pipe had been weakened by severe erosion.⁹²

Figure 14 illustrates the rupture in the drill pipe above the upper annular BOP.

The well flow previously was contained below the VBRs but now flowed through the ruptured drill pipe above the upper annular BOP. The *Deepwater Horizon* then drifted farther off location, pulling on the drill pipe until it parted at the rupture. Inspection of the parted drill pipe and drift-off calculations indicate that there likely was sufficient tension to part the ruptured drill pipe within six minutes after power loss.

Figure 15 illustrates the moment when the pipe parted due to the tension in the drill string; the photo demonstrates the tensile failure of the drill pipe.

3.4.4 Automatic Mode Function Activation (AMF)

The *Deepwater Horizon* BOP and multiplex (MUX) control system were fully operational at the time of the incident, and the drill crew successfully operated several functions — the upper annular BOP, two sets of VBRs, and the diverter — in response to the well-control event.⁹³ The explosions on the rig severed the communication link between the BOP and the rig, preventing surface control of the BOP emergency disconnect system (EDS).⁹⁴ As a result, efforts to activate the EDS from the bridge were unsuccessful.⁹⁵

The explosions and fire subsequently damaged or destroyed the BOP secondary hydraulic supply line hose and the BOP MUX control cables, resulting in the loss of hydraulic supply pressure and electrical power to the BOP. This, in turn, automatically activated the AMF system in both the blue and yellow pods. The AMF activated the high-pressure shear circuit to close the blind shear rams utilizing the stored hydraulic pressure in the accumulator bottles mounted on the lower BOP stack. Pressure from the accumulators closed the blind shear rams (BSRs) and activated the ST Locks on all of the closed rams (BSRs, upper VBR, and middle VBR). See *Figures 16 and 17*. When the BOP is operated from the surface via the control panels, the ST Locks are not automatically engaged; this is a manual function performed by the drill crew. The fact that the ST Locks were engaged on the BSRs and both VBRs confirms that the high-pressure shear circuit was activated by the AMF.^G

E 5.5-in. drill pipe = 23.75 in.² x 7,000 psi = 166,250 lb. lift.

F 5,750 psi surface pressure plus the hydrostatic pressure of seawater in the drill pipe.

G The *Deepwater Horizon* ST locks were not functioned as a standard practice when the BOP was subsea except for hurricane abandonment prior to disconnect of the LMRP from the lower BOP stack. It was unlikely that the driller/toolpusher activated the ST Lock lock function after closing the upper and middle VBRs. All functions on the MUX pods shifted to the vent position when power was lost to the pods. Closing pressure was then vented to the upper and middle VBRs. The rams stay closed with the assistance of adequate wellbore pressure. The AMF system fired the HP shear circuit locking the ST Locks behind the upper and middle VBRs moments after the power was lost to the pods. If the AMF had not fired, the rams would have had to have been held closed by only the wellbore pressure for 33.5 hours until the auto-shear pin was cut by an ROV. When the auto-shear pin was cut on April 22, 2010, at 7:30 a.m., there was no indication of fluid discharge from the control pods indicating that the BSR and the ST Locks were already in the closed and locked position. If the BSR was still open, approximately 30 gallons of fluid would visibly discharge from the open side of the BSR and ST Locks.

Condition of Yellow Pod

The yellow pod was fully functional at the time of the incident.

The yellow pod was retrieved from the BOP 15 days after the incident and transferred to the *Q4000*, the vessel used to assist with BOP intervention and other support activities.⁹⁶ The pod was inspected, tested, and prepared to operate the *Deepwater Horizon* BOP system for the post-incident response.^H During the inspection of testing of the yellow pod, it was determined that:

- The AMF batteries registered acceptable voltage levels (8.85V for both 9V SEM battery packs and 26V for the 27V battery pack).⁹⁷
- Solenoid 103 (for the HP shear circuit) did not function mechanically when activated with one SEM at a time (two SEMs per pod). Solenoid 103 was replaced with a spare solenoid and taken into evidence by the JIT investigation.
- Solenoid 3A (for the upper annular regulator increase) did not function mechanically when activated with one SEM at a time (two SEMs per pod). Solenoid 3A was replaced with a spare solenoid and taken into evidence by the Joint Investigation Team.
- The AMF system was re-tested and functioned as expected and designed.⁹⁸

The yellow pod was lowered and latched to the *Deepwater Horizon* BOP on May 19, 2010. The pod was used to operate functions remotely from the *Q4000* on the rig BOP stack for 114 days up until the BOP was loaded on the barge to be sent ashore on Sept. 10, 2010.

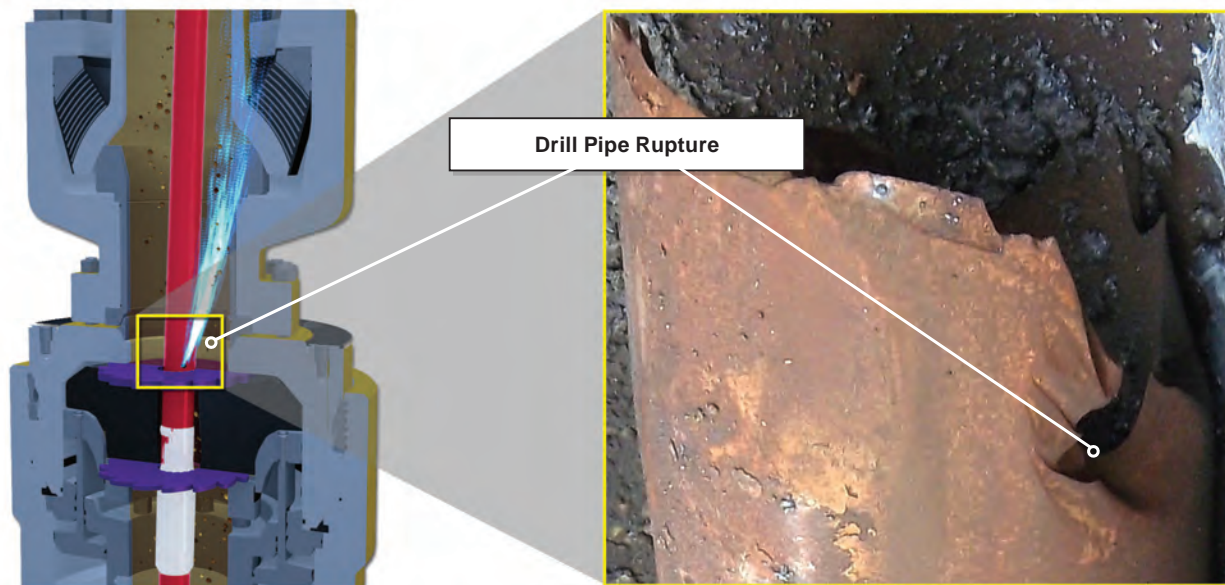

Figure 14 Rupture of Drill Pipe at Upper Annular BOP

The yellow pod AMF system was tested at NASA Michoud on March 3, 2011, with the original solenoid 103 installed. Testing of the yellow pod produced the following findings:

- The AMF batteries were still at acceptable voltage levels (8.67V for SEM A and 8.44V for SEM B 9V battery packs, and 28.15V for the 27V pod battery pack).

Original solenoid 103:

- Functioned hydraulically as designed with no leaks
- Functioned every time with both SEM A and SEM B activated (direct activation of the Portable Electronic

^H At all times during the process, a representative from the U.S. Coast Guard and the Bureau of Ocean Energy Management, Regulation and Enforcement (BOEMRE) was present to witness all work on the pod.

Test Unit (PETU) or by the AMF system)

- While technicians incorrectly described the E-cable and plug assembly as non-OEM supply, the parts were in fact made by Cameron's supplier. The E-cable and plug assembly were new when installed on the yellow pod in February 2010, prior to deploying the BOP on the Macondo well.
- Three functions of the AMF system were tested with SEM A and SEM B armed according to normal operating conditions when the BOP is subsea. The AMF functioned as expected and designed each time, functioning Solenoid 103 and pressurizing the pilot line to the HP shear circuit.⁹⁹
- Further testing of Solenoid 103 at NASA Michoud is ongoing at the time of publication of this report.

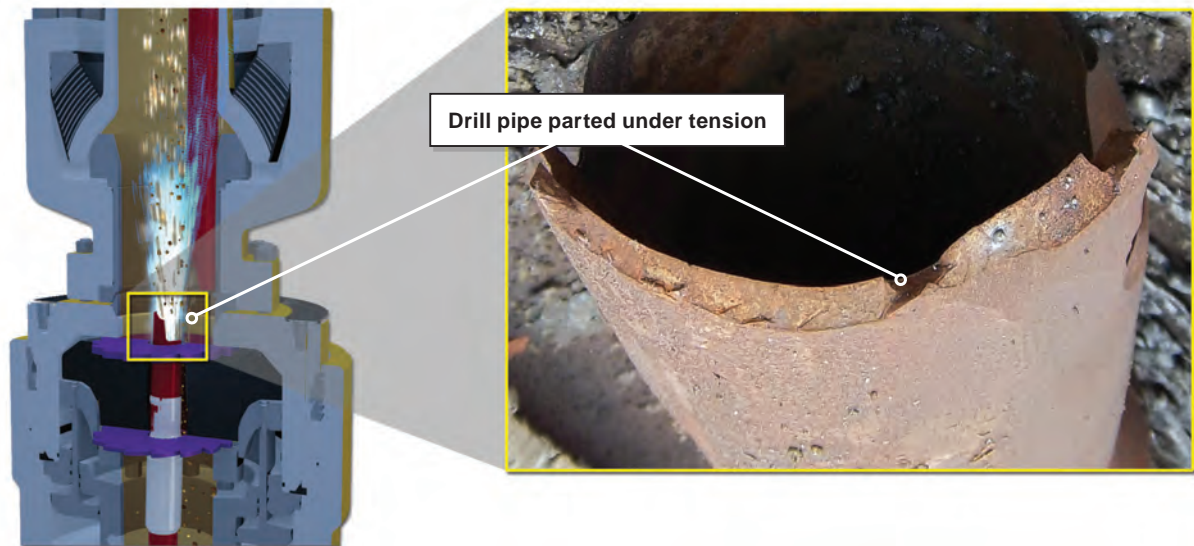

Figure 15 Tensile Separation of Drill Pipe at Upper Annular

Investigation Team Findings

Testing performed on the yellow pod at NASA Michoud confirms the AMF system activated solenoid 103, and solenoid 103 activated the HP shear circuit to close the BSRs at the time of the incident.¹⁰⁰

Condition of Blue Pod

The blue pod was fully functional at the time of the incident.

The blue pod was retrieved from the BOP 74 days after the incident and loaded onto the *Discoverer Enterprise*, a Transocean drillship on site to assist with post-incident activities.¹⁰¹ The pod was inspected, tested, and prepared to operate the *Deepwater Horizon* BOP for the post incident response.¹

During the surface inspection and testing of the blue pod, it was found that:

- The AMF battery voltage levels were recorded at 8.87V for SEM A 9V, 0.142V for SEM B 9V battery pack, and 7.61V for the 27V battery pack.¹⁰²
- The blue pod AMF system was tested and did not initiate the sequence (i.e., solenoid 103 was not activated due to low 27V battery power).¹⁰³
- When 230V power was re-applied from the PETU to the pod, the AMF system initiated and completed the sequence and activated solenoid 103.¹⁰⁴

¹ At all times during the process, a representative from the U.S. Coast Guard and the BOEMRE was present to witness all work on the pod.

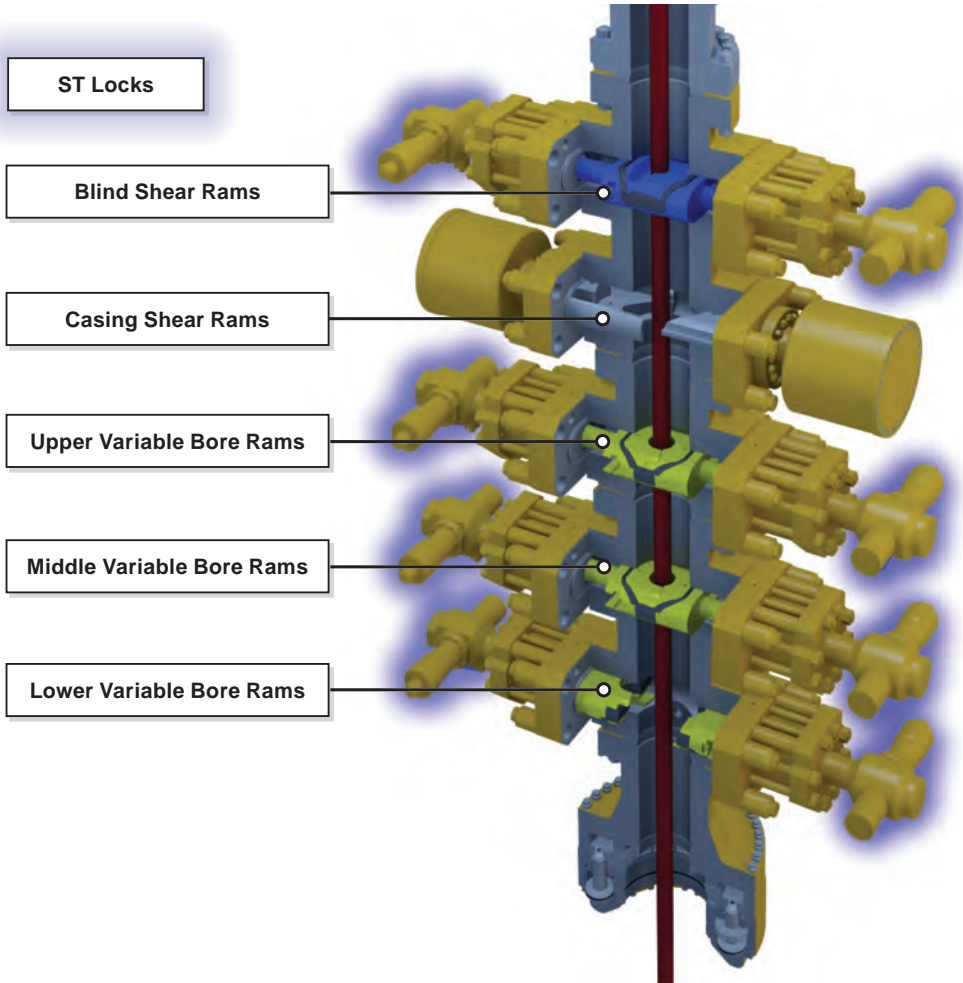

Figure 16 Position of Blind Shear Rams and VBRs Following AMF Activation.

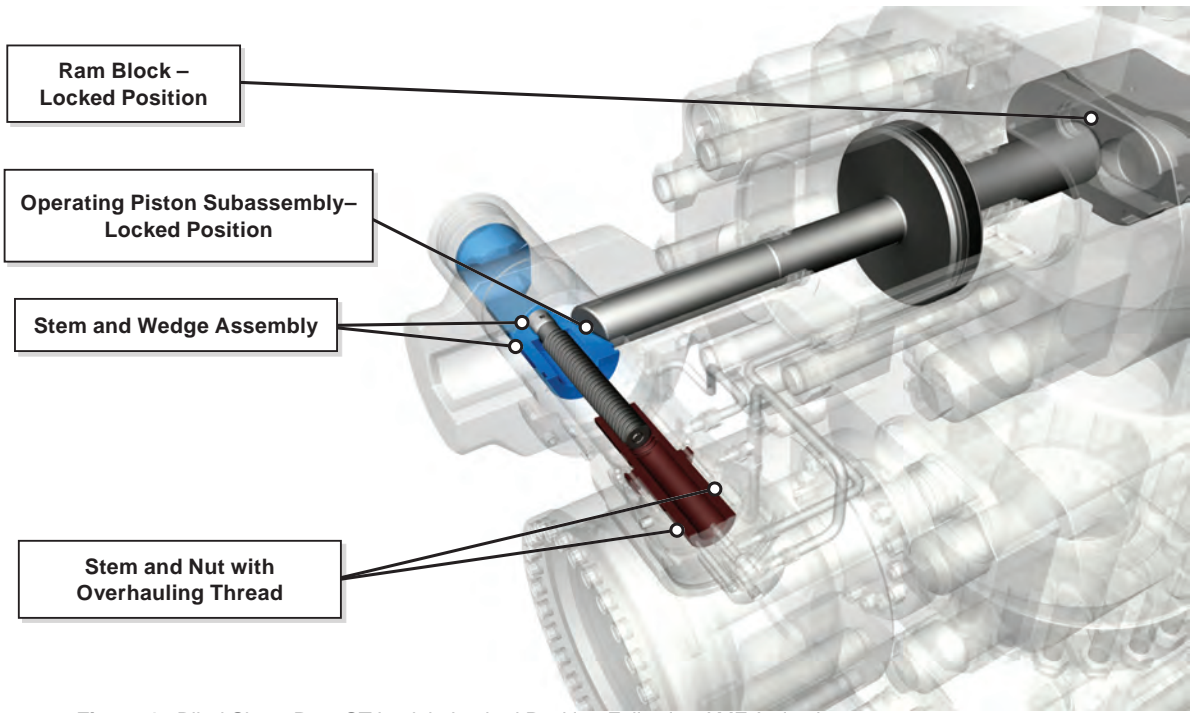

Figure 17 Blind Shear Ram ST Lock in Locked Position Following AMF Activation

The blue pod was lowered and latched to the *Deepwater Horizon* BOP on July 9, 2010. The pod was ready but not used for the incident response. It was recovered with the BOP in September 2010.

The blue pod AMF system was tested at NASA Michoud on March 3, 2011, with the following results:

- The AMF battery voltage levels were recorded at 8.90V for SEM A 9V battery, 8.61V for SEM B 9V and 0.71V for the 27V battery pack.¹⁰⁵
- It was determined by the NASA engineer at Michoud that the initial battery voltage readings taken in July 2010 on the *Discoverer Enterprise* were incorrectly measured by the technician. The readings taken on the pod at Michoud were verified three times and are correct.
- The AMF system was tested and did not initiate the sequence.¹⁰⁶
- When 230V power was re-applied from the PETU to the pod, the AMF system completed the sequence and activated solenoid 103.¹⁰⁷
- SEM A AMF processor was inactive, confirming that it had completed the sequence and shut down as designed.
- SEM B AMF processor was active, confirming that it had not completed the sequence due to a low amperage 9V battery pack.
- Further inspection of the blue pod AMF system is ongoing at NASA Michoud at the time of publication of this report.

Voltage measurements taken on the blue pod 9V AMF batteries showed that they were at satisfactory voltage levels; however, voltage tests alone are not indicative of the battery condition. The batteries must be tested under load to determine whether sufficient energy remains to operate the AMF processor.

Investigation Team Findings

The 9V battery for SEM B in the blue pod did not have sufficient power to boot the AMF processor, which triggered a cycle that attempted activating the process every three minutes, reducing battery charge each time. The AMF cards have a “low voltage drop out” feature that prevents the 9V battery from powering the Programmable Logic Controller (PLC) when voltage is less than 5V. This allows the 9V battery to rest and regenerate; however, a higher voltage reading is not indicative of the remaining stored energy. The investigation team demonstrated this phenomenon in the lab where a 9V battery was drained to 0V at 32°F. The voltage readings increased as the battery returned to room temperature but tested near 0V when put under load, indicating that voltage readings alone are not a valid indicator of battery condition.

Once the AMF is armed at the surface control panel, upon loss of power from the rig to the BOP, the 27V battery will power the subsea transducer module (STM) that measures surface hydraulic and subsea hydrostatic pressures that are parameters used to activate the AMF sequence. The 27V battery remains connected to the STM while both SEM PLCs boot, execute, then reset and disconnect the 27V battery from the STM. In the case of the blue pod, SEM B PLC did not boot or reset (indicating low 9V battery power). From the time of the incident until the blue pod was recovered 74 days later on the *Discoverer Enterprise*, the SEM B AMF card continued to cycle the 27V battery power to the STM transducers each time the AMF card initiated the restart process, thus draining the 27V battery pack. The “dead” 27V battery combined with SEM B not re-setting during the AMF test at the NASA Michoud facility indicates the blue pod AMF activated on SEM A at the time of the incident.

Testing performed by the investigation team is further explained in *Appendix N*, and testing performed on the blue pod at NASA Michoud indicated that the AMF system activated solenoid 103 on SEM A, and then solenoid 103 activated the HP shear circuit to close the BSRs at the time of the incident.¹⁰⁸

3.4.5 Blind Shear Rams

Within minutes after the first explosion, communication from the rig to the pods was lost, and the AMF activated the high-pressure shear function to close the BSRs. Forensic evaluation by DNV revealed that a portion of the drill pipe cross section was outside of the BSR shearing blades and became trapped between the ram block faces, preventing the blocks from completely shearing the pipe and fully closing and sealing. This also prevented upward movement of the drill pipe and exposed it to further flow wash at the upper annular.¹⁰⁹ The resulting flow path allowed the high-pressure fluid to wash around and through the BSR ram blocks, the BOP stack, and the drill pipe.¹¹⁰ The erosion around the BSR from the washout is shown in *Figure 18*. Hydrocarbons flowed up through the drill pipe held in the VBRs, around the flow-washed areas of the BSRs, around the tool joint in the annular BOP element, and up the drilling riser.

Approximately 30 minutes after the fire began, the drill line (hoisting cable) severed completely and the traveling block fell to the rig floor.¹¹¹ The drill pipe held by the top drive fell, and the severed bottom of the drill pipe landed on the partially closed upper annular BOP element.¹¹²

Upon shearing and subsequent parting of the drill pipe at the BSRs, pressure and fluid flow forced the section of pipe above the BSRs up through the upper annular BOP element and into the riser.^{113, J}

Figure 19 illustrates the sheared pipe being forced above the annular from the flow of hydrocarbons.

At 7:30 a.m. on April 22, 2010, an ROV cut the auto-shear plunger pin mounted on the lower BOP stack to activate the high pressure shear circuit using the remaining pressure^K in the eight 80-gallon accumulators mounted on the lower BOP stack to close the blind shear rams. The blind shear rams may have been closed further by this action.

At 10:30 a.m. on April 22, 2010 the *Deepwater Horizon* sank, and the riser pipe buckled 4 ft. above the riser adapter, trapping the two sections of drill pipe in the bent section of riser. *Figure 20* shows the final position of the riser. *Table 2* and *Figure 21* show the details of the drill pipe segments recovered from the riser and the BOP during the forensic analysis of the *Deepwater Horizon* BOP by the JIT at the NASA Michoud facility. See *Appendix L*.

3.4.6 Flow through the BOP

As previously outlined, the BOP is used to seal the wellbore in the event that the well becomes underbalanced and hydrocarbons enter the wellbore and begin to displace the drilling mud to the surface.¹¹⁴ The investigation team has concluded that the *Deepwater Horizon* BOP stack functioned but was unable to seal off the well as it was overcome by the conditions created by the extreme dynamic flow.

The *Deepwater Horizon* BOP stack included a total of seven BOPs. Five BOPs were used for sealing wellbore pressure, including two annular preventers, two variable bore rams (VBRs), and one blind shear ram (BSR) preventer. The other two BOPs were a non-sealing casing shear ram (CSR) and a test ram.

The five sealing barriers of the *Deepwater Horizon* BOP stack are designed to contain wellbore pressures as high as 15,000 psi (10,000 psi for the upper annular BOP element; 5,000 psi for the lower annular BOP element). However, they are tested in static conditions and were not analyzed by the manufacturer to determine limits on containing dynamic flows.¹¹⁵ All of these barriers use replaceable rubber seals that were newly installed prior to arrival of the rig at the Macondo well. The BOP stack and components frequently were function and pressure tested prior to and during the drilling of the Macondo well.

BOP design requirements from the API do not address sealing on high flow rates. High flow rates primarily affect the sealing of the rams, the ram packers, and the annular packers.¹¹⁶ API provides only minimal guidance on the design of these elements because the manufacturer controls the design.¹¹⁷ Additionally, all design verification

J The timing for this event is known to be after the pipe parted and before the *Deepwater Horizon* sank.

K The AMF activated the high pressure shear circuit minutes after the explosions and fires utilizing approximately 30 gallons of the stored fluid in the eight 80-gallon accumulators mounted on the lower BOP. When the AMF vented off the high pressure shear circuit, 30 seconds after it was activated, the remaining pressure in the accumulator bottles was preserved for use when the auto-shear plunger activated the high pressure shear circuit.

testing of the rams, and the ram and annular packers, is performed in static conditions.¹¹⁸

If there is flow from the formation into the wellbore, the expansion of gas as it migrates up the wellbore will displace the drilling mud through the BOP stack. A significant expansion of a gas influx will push the flow velocities to a point where they exceed the capabilities of the BOP stack and may prevent ram and annular BOP elements from effectively sealing the well. During high-velocity well flow conditions, when ram or annular BOP elements are closing, the flow area in the bore of the BOP gradually is reduced, resulting in even higher flow velocity and pressure.¹¹⁹

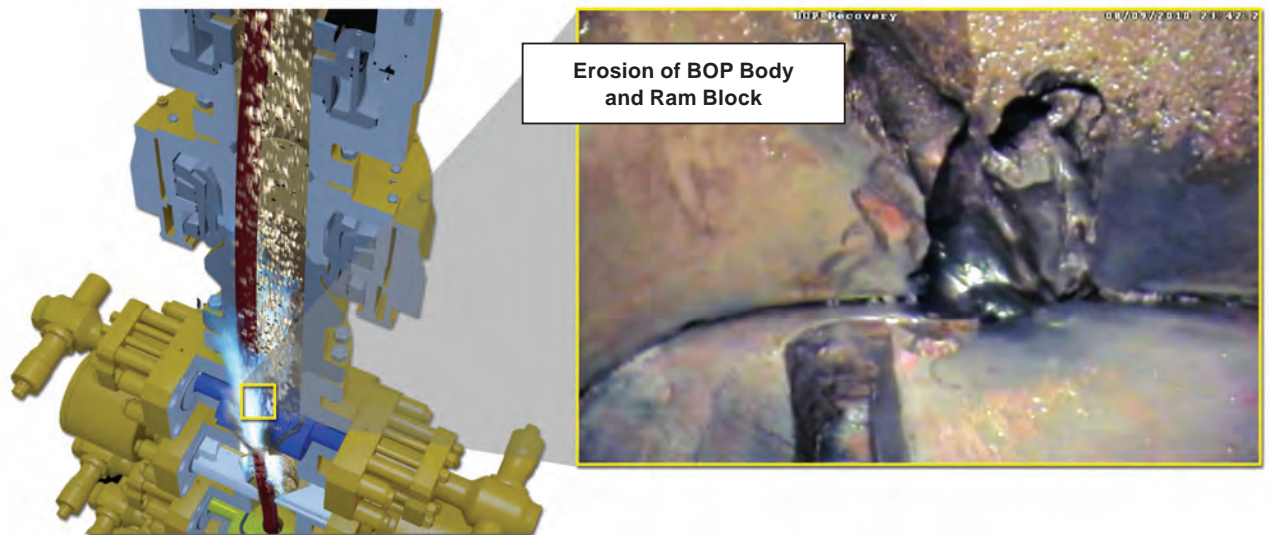

Figure 18 Eroded Area 2 around the Blind Shear Ram

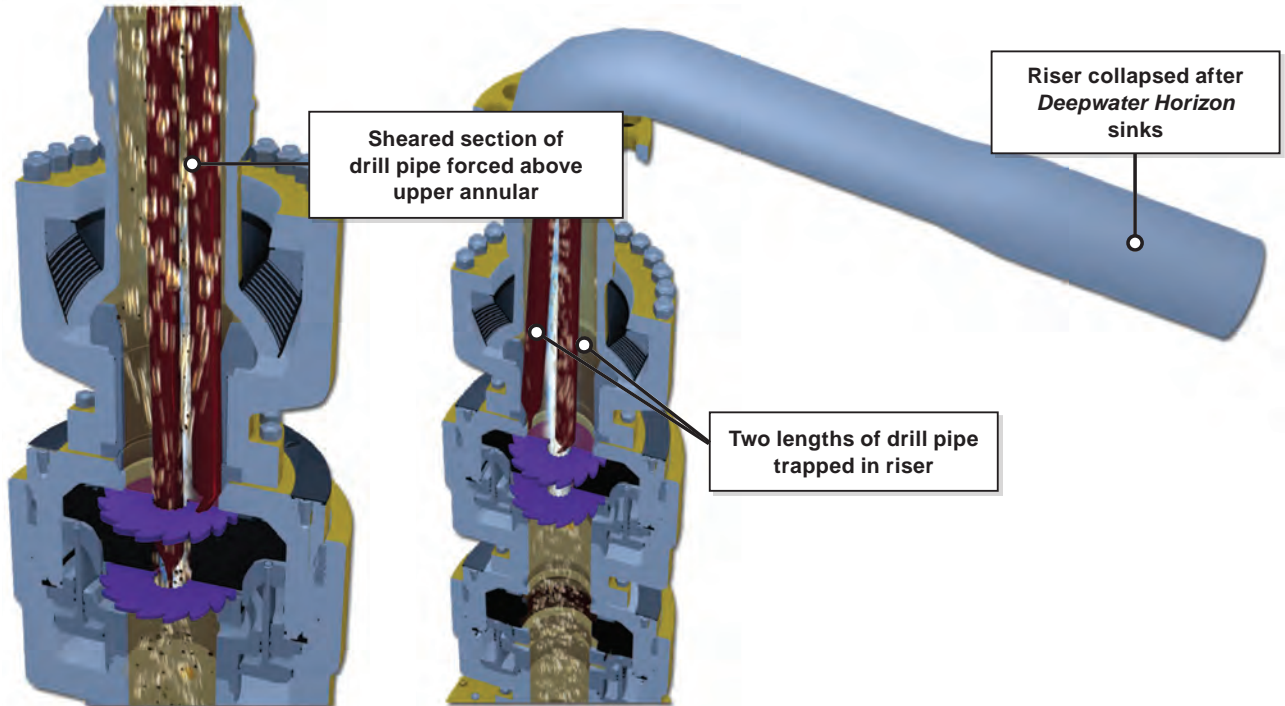

Figure 19 Sheared Drill Pipe Forced through Upper Annular

Figure 20 Final Position of Riser

The ram and annular BOPs do not close instantaneously to seal the wellbore. They are activated by hydraulic fluid moving pistons and, therefore, take seconds to move from the open to closed position (16 seconds for ram BOPs and 26 seconds for annular BOPs of the *Deepwater Horizon* BOP stack).¹²⁰ When BOPs are closed during high-velocity conditions, increased jetting pressure and fluid flow may damage the seals and prevent the annulars, VBRs, and BSRs from sealing, thus preventing isolation of the wellbore flow. Leakage through ram or annular BOP elements would continue to erode the BOP components and allow the influx of hydrocarbons to continue.

3.4.7 Blowout Preventer (BOP) Findings of Fact

The findings from the investigation team and those of independent industry experts conclude the following:

- The *Deepwater Horizon* BOP and MUX control system were fully operational at the time of the incident and functioned as designed.
- The equipment was maintained in accordance with Transocean requirements, and all implemented modifications maintained or improved the performance of the BOP.
- Minor leaks identified pre-incident did not adversely affect the functionality of the BOP.
- Upon detection of the flowing well, the drill crew shut in the well by (1) closing the upper annular BOP; (2) closing the diverter packer and diverting the flow to the mud-gas separator; and (3) closing the upper and middle VBRs, which initially sealed the well.
- The high flow rate of hydrocarbons from the well prevented the annular BOP element from sealing on the drill pipe and subsequently eroded the drill pipe in the sealing area.
- Increased pressure inside the drill pipe and external damage caused by erosion ruptured the drill pipe, allowing hydrocarbons to flow up the riser. The drill pipe then parted as the *Deepwater Horizon* drifted off location.
- The explosions and fire severed the communication link between the BOP and the rig, preventing activation of the BOP emergency disconnect system (EDS) from the toolpushers' control panel.
- The automatic mode function (AMF) operated as designed to close the blind shear rams following the explosion.
- High pressure bowed the drill pipe partially outside of the BSR shearing blades, trapping it between the ram blocks and preventing the BSR from completely shearing the pipe, fully closing, and sealing.

#	Description	Length (inches)
A	Bottom of upper annular element to the center of the blind shear ram	234
XX	Start of the flow-wash damage to the tool joint connection break	6
AA-1	Tool joint connection break at flow-wash end to the riser shear cut	111.5
AA-2	Riser shear cut to saw cut section	7.5
AA-3	Section recovered from inside the upper annular in the <i>Deepwater Horizons</i> LMRP	109
AA	Total length of drill pipe section	234
B	Center of the blind shear ram to center of casing shear ram	43.5
BB	Section recovered from below the BSR and above the CSR	42
C	Center of the casing shear ram to the center of the lower test rams	142
CC	Section recovered from below the CSR that extends to the lower test rams	142
D	Bottom of upper annular element to the center of the lower test rams	420
XX	Tool joint connection to the start of the flow-wash damage on the tool joint	6
AA-1	Upper tool joint connection break at flow-wash end to riser shear cut	111.5
AA-2	Riser shear cut to saw cut section	7.5
AA-3	Section recovered from inside the upper annular in the <i>Deepwater Horizons</i> LMRP	109
BB	Section recovered from below the BSR and above the CSR	42
CC	Section recovered from below the CSR that extends to the lower test rams	142
DD	Total length of drill pipe section (AA + BB + CC)	418
E	Nominal Length of the <i>Deepwater Horizons</i> S-135 Drill Pipe = (+/- 6 inches)	552
EE-1	Upper section recovered from the riser joint above the BOP	388
EE-2	Section recovered from inside the upper annular in the <i>Deepwater Horizons</i> LMRP	136
EE-3	Flow-washed tool joint connection to failed end	27
EE	Total length of upper drill pipe section	551

Table 2 Drill Pipe Measurements (Refer to Figure 22)

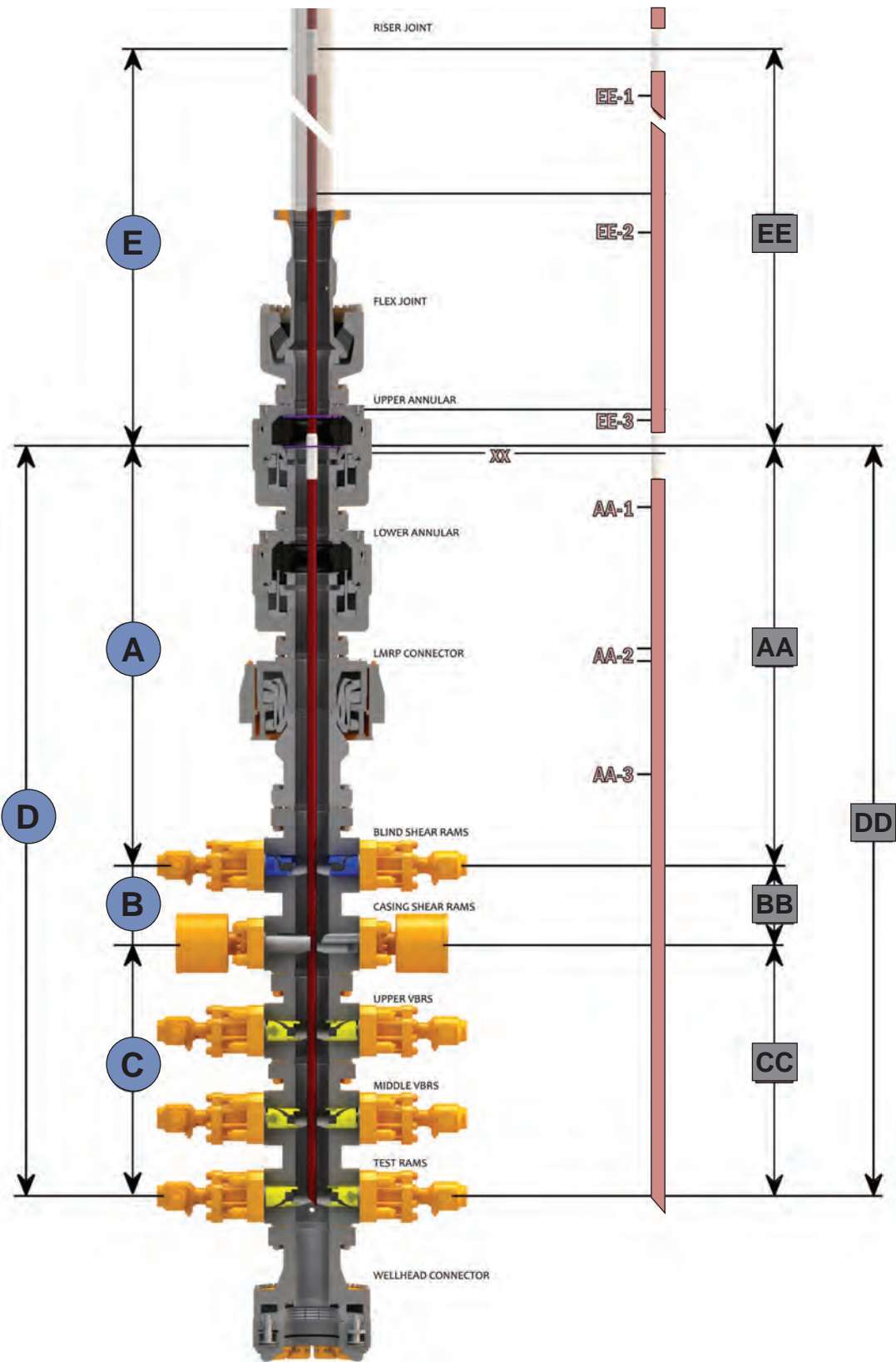

Figure 21 Drill Pipe Location in the BOP at the Time the BSR Cut the Pipe

1. University of Texas, Petroleum Extension Service, A Primer of Oilwell Drilling, Seventh Edition, 2008, 184, 207, 223, 224.
2. The University of Texas, Petroleum Extension Service, A Primer of Oilwell Drilling, Seventh Edition, 2008, 184–188.
3. The University of Texas, Petroleum Extension Service, A Primer of Oilwell Drilling, Seventh Edition, 2008, 52.
4. The University of Texas, Petroleum Extension Service, A Primer of Oilwell Drilling, Seventh Edition, 2008, 186.
5. *Ibid.*
6. *Ibid.*
7. American Petroleum Institute, Recommended Practices for Blowout Prevention Equipment Systems for Drilling Wells, RP 53, Third Edition, March 1997, § 3.1.42, 4.
8. The University of Texas, Petroleum Extension Service, A Primer of Oilwell Drilling, Seventh Edition, 2008, 184, 186.
9. *Ibid.*
10. *Ibid.*
11. The University of Texas, Petroleum Extension Service, A Primer of Oilwell Drilling, Seventh Edition, 2008, 184, 227.
12. American Petroleum Institute, Specification for Drill Through Equipment, 16A, Second Edition, December 1997.
13. Testimony of Curt Kuchta, Hearing before the *Deepwater Horizon* Joint Investigation Team, May 27, 2010, 171:17–172:4; Testimony of Chris Pleasant, Hearing before the *Deepwater Horizon* Joint Investigation Team, May 28, 2010, 105:23–106:7; Testimony of Jimmy Harrell, Hearing before the *Deepwater Horizon* Joint Investigation Team, May 27, 2010, 10-17–11:10.
14. Testimony of Jimmy Harrell, Hearing before the *Deepwater Horizon* Joint Investigation Team, May 27, 2010, 12–22; Testimony of Chris Pleasant, Hearing before the *Deepwater Horizon* Joint Investigation Team, May 28, 2010, 132:9–25; Testimony of Steve Bertone, Hearing before the *Deepwater Horizon* Joint Investigation Team, June 20, 2010, 41:7–15.
15. Cameron, R&B Falcon *Deepwater Horizon* TL BOP Stack Operation & Maintenance Manual, Initial Release, Rev. A, September 2000, 1-16, 1-17; Vastar Resources Inc. and R&B Falcon Drilling Co., Exhibit B-2 of Drilling Contract RBS-8D, Semisubmersible Drilling Unit, Contract No. 980249, Dec. 9, 1998, §E.2.9, 33, §E.3.2, 33.
16. Cameron, R&B Falcon *Deepwater Horizon* TL BOP Stack Operation & Maintenance Manual, Initial Release, Rev. A, September 2000, 1–7, 1–11.
17. American Petroleum Institute, Specification for Drill Through Equipment, 16A, Second Edition, December 1997, §3.1.6, 4.
18. Cameron, R&B Falcon *Deepwater Horizon* TL BOP Stack Operation & Maintenance Manual, Initial Release, Rev. A, September 2000, 1–7, 1–8, 1–11.
19. Cameron, R&B Falcon *Deepwater Horizon* TL BOP Stack Operation & Maintenance Manual, Initial Release, Rev. A, September 2000, 3–7, 3–8, 3–34, 3–38.
20. *Ibid.*
21. *Deepwater Horizon* TL BOP Stack Operation & Maintenance Manual, Initial Release, Rev. A, September 2000, 3–10, 3–11, 3–37.
22. *Deepwater Horizon* TL BOP Stack Operation & Maintenance Manual, Initial Release, Rev. A, September 2000, 3–4, 3–5, 3–37.
23. *Ibid.*
24. ABB Vetco Gray, Databook, §A-2.
25. American Petroleum Institute, Specification for Drill Through Equipment, 16A, Second Edition, December 1997, §3.1.7, 4.
26. Cameron, R&B Falcon *Deepwater Horizon* TL BOP Stack Operation & Maintenance Manual, Initial Release, Rev. A, September 2000, 1-8, 1-11; Vastar Resources Inc. and R&B Falcon Drilling Co., Exhibit B-2 of Drilling Contract RBS-8D, Semisubmersible Drilling Unit, Contract No. 980249, Dec. 9, 1998, 32, 33.
27. Cameron, R&B Falcon *Deepwater Horizon* TL BOP Stack Operation & Maintenance Manual, Initial Release, Rev. A, September 2000, 3-34, 3-37, 3-38.
28. American Petroleum Institute, Specification for Drill Through Equipment, 16A, Second Edition, 5, December 1997, §3.1.56, 5.

29. Cameron, R&B Falcon *Deepwater Horizon* TL BOP Stack Operation & Maintenance Manual, Initial Release, Rev. A, September 2000, 3-37.
30. George Coltrin e-mail to Darrell Boudreaux, et. al., Oct. 19, 2004, BP-HZN-BLY00056058; Cameron Field Service Order 121096, January 3, 2005, CAM_CIV_0011451; Change Proposal, Proposal No. SS-10, *Deepwater Horizon*, BOP Test Rams, Nov. 21, 2004.
31. American Petroleum Institute, Specification for Drill Through Equipment, 16A, Second Edition, December 1997, §3.1.55, 5.
32. Cameron, Cameron Engineering Bulletin EB 852D, Rev. A1, Oct. 30, 1998, 7; IADC Deepwater Well Control Guidelines, First Edition, October 1998, §3.1.2, 3-3.
33. *Deepwater Horizon* TL BOP Stack Operation & Maintenance Manual, Initial Release, Rev. A, September 2000, 1-7, 1-11.
34. ABB Vetco Gray, Field Service Manual for R&B Falcon RBS8D 21" HMF H Marine Riser System and Wellhead Connector Manual, FSM00105, June 2000, §1, Part 1.1, Operating & Service Procedure 6192, BP-HZN-BLY00031145.
35. American Petroleum Institute, Recommended Practice for Diverter Systems Equipment and Operations, RP64, Second Edition, November 2001, §5.1, 6-7.
36. Hydril, R&B Falcon RBS-8D *Deepwater Horizon*, Hydril S.O. 615911 P.O. 087 00014, FS 21x60-500 Diverter Housing, FS 21x60-500 Diverter, FS 21x60-500 Handling Tool, June 23, 2010, 1-1 – 1-3, 3-5 (Table 3-2).
37. Hydril, R&B Falcon RBS-8D *Deepwater Horizon* Hydril S.O. 615911 P.O. 087-00014, June 23, 2000, 1-1 to 1-5.
38. American Petroleum Institute, Recommended Practice for Design, Selection, Operation and Maintenance of Marine Drilling Riser Systems, 16Q (RP 16Q), First Edition, November 1, 1993, §2.4.1, 6, 7 (Figure 1-1).
39. Hydrilift, Reading & Bates RBS8D *Deepwater Horizon* N-Line Drilling Riser Tensioner System Operation and Maintenance Manual P/N HA13862, Rev. A, Initial Release, 10/06/00, Revision: B- As Built, 10.06.00, §2, 2 of 8 (11 of 267).
40. ABB Vetco Gray, Field Service Manual for R&B Falcon RBS8D 21" HMF-H Marine Riser System and Wellhead Connector Manual, FSM00105, June 2000, § 2, 66, BP-HZN-BLY00031145, 210.
41. ABB Vetco Gray, Field Service Manual for R&B Falcon RBS8D 21" HMF-H Marine Riser System and Wellhead Connector Manual, FSM00105, June 2000, § 2, 66, BP-HZN-BLY00031145, 203.
42. ABB Vetco Gray, Field Service Manual for R&B Falcon RBS8D 21" HMF-H Marine Riser System and Wellhead Connector Manual, FSM00105, June 2000, § 2, Part 2.1, Operating & Service Procedure 6215, BP-HZN-BLY00031145, 210.
43. Cameron Controls, RBS8D Multiplex BOP Control System, R&B Falcon – *Deepwater Horizon*, 139 or 56 of 79.
44. Cameron Controls, RBS8D Multiplex BOP Control System, R&B Falcon – *Deepwater Horizon*, 130, or 50 of 79.
45. Cameron Controls, RBS8D Multiplex BOP Control System, R&B Falcon – *Deepwater Horizon*, Vol. 1, 2000, 9.
46. Cameron, Emergency, Back Up and Deepwater Safety Systems, May 2004, 12.
47. Cameron, Emergency, Back Up and Deepwater Safety Systems, May 2004, 5.
48. American Petroleum Institute, Specification for Control Systems for Drilling Well Control Equipment and Control Systems for Diverter Equipment, Spec 16D, Second Edition, §5.7.1, 37.
49. American Petroleum Institute, Specification for Control Systems for Drilling Well Control Equipment and Control Systems for Diverter Equipment, Spec 16D, Second Edition, §5.8.3, 39–40.
50. American Petroleum Institute, Specification for Control Systems for Drilling Well Control Equipment and Control Systems for Diverter Equipment, Spec 16D, Second Edition, §5.9.2, 41.
51. See Appendix P; American Petroleum Institute, Specification for Control Systems for Drilling Well Control Equipment and Control Systems for Diverter Equipment, Spec 16D, Second Edition, §5.9.3, 41.
52. Cameron Controls, RBS8D Multiplex BOP Control System, R&B Falcon – *Deepwater Horizon*, Vol. 1, 2000, 77.
53. Subsea Maintenance Philosophy, Family 400, Recommended Practices HQS-OPS-RP-400-001, May 16, 2007.
54. 365 Day-Ram BOP NDT Job Plan Report, Oct. 16, 2009.
55. DNV, Forensic Examination of *Deepwater Horizon* Blowout Preventer, March 20, 2011.

56. PM05-Connector-Service Job Plan Report, Nov. 6, 2009.
57. SPM01 CTRU-Service Job Plan Report, July 20, 2009.
58. SPM01-PIPE-BOP Choke & Kill Checks Job Plan Report, Nov. 6, 2009.
59. Daily Operations Report, February 23, 2010, BP-HZN-MBI 135226.
60. *Deepwater Horizon* Subsea Supervisor (Owen McWhorter) e-mail to *Deepwater Horizon* OIM, Feb. 19, 2010.
61. Testimony of Mark Hay, Hearing before the *Deepwater Horizon* Joint Investigation Team, Aug. 25, 2010, 246, 10–247:17.
62. Boa SubC Daily Log, April 26, 2010.
63. *Ibid.*
64. BP, *Deepwater Horizon* Accident Investigation Report, Sept. 8, 2010, 170.
65. 30 C.F.R. §250.446–449.
66. Stress Engineering Services Inc., Hydraulic Analysis of Macondo #252 Well Prior to Incident of April 20, 2010; DNV, Forensic Examination of *Deepwater Horizon* Blowout Preventer, March 20, 2011.
67. Testimony of Micah Sandell, Hearing before the *Deepwater Horizon* Joint Investigation Team, May 29, 2010, 9–11.
68. Sperry Drilling Services data logs (drilling parameters with cement unit data), April 15–20, 2010; DNV, Forensic Examination of *Deepwater Horizon* Blowout Preventer, March 20, 2011.
69. Transocean Well Control Handbook, March 31, 2009, §5, Subsection 3, 81.
70. Stress Engineering Services Inc., Hydraulic Analysis of Macondo #252 Well Prior to Incident of April 20, 2010; Stress Engineering Services Inc. Structural Analysis of the Macondo #252 Work String.
71. DNV, Forensic Examination of *Deepwater Horizon* Blowout Preventer, March 20, 2011.
72. Sperry Drilling Services data logs (mud pit data), April 19–20, 2010, BP-TO11000827.
73. Sperry Drilling Services data logs (drilling parameters), April 5, 2010–April 20, 2010; Sperry Drilling Services data logs (drilling parameters with cement unit data), April 15–20, 2010.
74. BOP Subsea Hydrostatic Test, Feb. 10, 2010, 3.
75. *Deepwater Horizon* TL BOP Stack Operation & Maintenance Manual, Initial Release, Rev. A, September 2000, 3-74, 3-78.
76. BP Investigation Team Interview of Donald Vidrine, April 23, 2010.
77. Stress Engineering Services Inc., Hydraulic Analysis of Macondo #252 Well Prior to Incident of April 20, 2010; BP Well Control Manual, Transocean Well Control Handbook, March 31, 2009; §8, Subsection 4, 22–24.
78. Stress Engineering Services Inc., Hydraulic Analysis of Macondo #252 Well Prior to Incident of April 20, 2010; BP Investigation Team Interview of Donald Vidrine, April 23, 2010.
79. Sperry Drilling Services data logs (drilling parameters), April 5–20, 2010; Sperry Drilling Services data logs (drilling parameters with cement unit data), April 15–20, 2010.
80. Testimony of Heber Morales, Hearing before the *Deepwater Horizon* Joint Investigation Team, May 29, 2010, 148–150; Sperry Drilling Services data logs (drilling parameters), April 5–20, 2010; Sperry Drilling Services data logs (drilling parameters with cement unit data), April 15–20, 2010.
81. Stress Engineering Services Inc., Hydraulic Analysis of Macondo #252 Well Prior to Incident of April 20, 2010; DNV, Forensic Examination of *Deepwater Horizon* Blowout Preventer, March 20, 2011. Sperry Drilling Services data logs (drilling parameters), April 5–20, 2010; Sperry Drilling Services data logs (drilling parameters with cement unit data), April 15–20, 2010.
82. BPTODDI, ERC e-mail to James Bjornestad, et. al., May 26, 2010.
83. BP, *Deepwater Horizon* Accident Investigation Report, Sept. 8, 2010, BP-HZN-BLY0000001, 161–162.
84. Cameron Controls, Daily Report Sheet, Subsea Pod Intervention, Horizon, BP, May 5, 2010, 3.

85. Expro and Oceaneering video taken in the bore of the BOP on board the *Q4000* - September 2010.
86. Preliminary BOP Function Timeline, May 11, 2010.
87. BP, *Deepwater Horizon* Accident Investigation Report, Sept. 8, 2010, BP-HZN-BLY0000001, 161–162.
88. DNV, Forensic Examination of *Deepwater Horizon* Blowout Preventer, March 20, 2011.
89. Stress Engineering Services Inc. Structural Analysis of the Macondo #252 Work String.
90. Stress Engineering Services Inc. Structural Analysis of the Macondo #252 Work String.
91. Sperry Drilling Services data logs (drilling parameters), April 5–20, 2010.
92. DNV, Forensic Examination of *Deepwater Horizon* Blowout Preventer, March 20, 2011.
93. See Appendices H, I, K, N, and O. DNV, Forensic Examination of *Deepwater Horizon* Blowout Preventer, March 20, 2011.
94. Testimony of Curt Kuchta, Hearing before the *Deepwater Horizon* Joint Investigation Team, May 27, 2010, 171:17–172:4; Testimony of Chris Pleasant, Hearing before the *Deepwater Horizon* Joint Investigation Team, May 28, 2010, 105:23–106:7; Testimony of Jimmy Harrell, Hearing before the *Deepwater Horizon* Joint Investigation Team, May 27, 2010, 10-17–11:10.
95. Testimony of Jimmy Harrell, Hearing before the *Deepwater Horizon* Joint Investigation Team, May 27, 2010, 12–22; Testimony of Chris Pleasant, Hearing before the *Deepwater Horizon* Joint Investigation Team, May 28, 2010, 132:9–25; Testimony of Steve Bertone, Hearing before the *Deepwater Horizon* Joint Investigation Team, June 20, 2010, 41:7–15.
96. Cameron Controls, Daily Report Sheet, Subsea Pod Intervention, Horizon, BP, May 5, 2010, 1.
97. Cameron Controls, Daily Report Sheet, Subsea Pod Intervention, Horizon, BP, May 5, 2010, 3, 8.
98. Cameron Controls, Daily Report Sheet, Subsea Pod Intervention, Horizon, BP, May 5, 2010, 3.
99. See Appendices N and O; DNV, Forensic Examination of *Deepwater Horizon* Blowout Preventer, March 20, 2011.
100. *Ibid.*
101. Cameron Controls, Daily Report Sheet, Subsea Blue Pod Intervention, Horizon/BP, June 28, 2010.
102. Cameron Controls, Daily Report Sheet, Subsea Blue Pod Intervention, Horizon/BP, June 28, 2010.
103. *Ibid.*
104. *Ibid.*
105. See Appendix N; DNV, Forensic Examination of *Deepwater Horizon* Blowout Preventer, March 20, 2011.
106. *Ibid.*
107. *Ibid.*
108. See Appendices N and O; DNV, Forensic Examination of *Deepwater Horizon* Blowout Preventer, March 20, 2011.
109. See Appendix O; DNV, Forensic Examination of *Deepwater Horizon* Blowout Preventer, March 20, 2011.
110. See Appendix L; DNV, Forensic Examination of *Deepwater Horizon* Blowout Preventer, March 20, 2011.
111. Testimony of Daun Winslow, Hearing before the *Deepwater Horizon* Joint Investigation Team, Aug. 24, 2010, 13:17–25.
112. See Appendix L; DNV, Forensic Examination of *Deepwater Horizon* Blowout Preventer, March 20, 2011.
113. *Ibid.*
114. The University of Texas, Petroleum Extension Service, A Primer of Oilwell Drilling, Seventh Edition, 2008, 184.
115. American Petroleum Institute, Specification for Drill Through Equipment, 16A, Second Edition, December 1997, §4.5, 18, §4.5.1.2, 18; §4.7, 19.
116. American Petroleum Institute, Specification for Drill Through Equipment, 16A, Second Edition, December 1997, §4.4.2.1.18; American Petroleum Institute, Specification for Drill Through Equipment, 16A, Second Edition, December 1997, §4, 6.

117. American Petroleum Institute, Specification for Drill Through Equipment, 16A, Second Edition, December 1997, §4.4.4, 18.
118. American Petroleum Institute, Specification for Drill Through Equipment, 16A, Second Edition, December 1997, §4.5, 18, §4.5.1.2, 18; §4.7, 19.
119. Stress Engineering Services Inc., Hydraulic Analysis of Macondo #252 Well Prior to Incident of April 20, 2010.
120. *Deepwater Horizon* BOP Subsea Test, Well Num. MC 252 Macondo #1, Feb. 10–11, 2010.

3.5 Gas Dispersion and Ignition

3.5.1 Gas Dispersion

The investigation team used industry experts and advanced modeling techniques to simulate and attempt to replicate the possible flow path, volume, and concentration of gas after it reached the rig. Migration and dispersion would have been impacted by a number of factors, many of which are not known. While it is not possible to model the dispersion exactly, the following sections set forth the findings of the team regarding the most likely path, volume, and timing, and identify potential release locations.

Mud began flowing from the rotary onto the deck of the *Deepwater Horizon* around 9:45 p.m.¹ The drill crew diverted the flow through the mud-gas separator (MGS) and began taking further steps necessary to shut in the well.² Despite those actions, the flow could not be controlled as gas was already above the blowout preventer (BOP) and rapidly picking up speed as it expanded upward. By 9:46 p.m., the flow had overwhelmed the MGS and gas started spreading across the aft deck and into nearby internal spaces, triggering alarms as it spread.³ At approximately 9:49 p.m., the rig lost power. The first explosion occurred shortly thereafter, followed almost immediately by a second explosion.⁴ The investigation team concluded that the explosions were virtually inevitable due to the rapid dispersion of flammable vapor across the drill floor and other areas of the *Deepwater Horizon*.

Gas Release Locations

Based on witness testimony and the gas dispersion analysis, the investigation team found that it is most likely that the flow exceeded the capacities of several rig systems including the MGS, the slip joint, and the diverter/rotary table packer, resulting in multiple flow paths.⁵ See *Figure 1*.

The wellbore fluids most likely were released onboard the *Deepwater Horizon* at the following locations:

- Mud-gas separator 12-in. vent to top of derrick
- Mud-gas separator 10-in. mud return line into gumbo box
- Mud-gas separator 6-in. pressure relief line
- Mud-gas separator 6-in. vacuum breaker
- Mud-gas separator connection to mini trip tank overflow
- Slip joint
- Diverter/rotary table packer

The flow path modeling scenarios are summarized below:

Mud-Gas Separator (MGS)

The crew diverted flow to the MGS. See *Figure 2* for the location of the MGS on the rig floor. When the drill crew detected flow on the trip tank, the flow rate was within the capacity of the MGS, as measured on the trip tank. After flow was diverted to the MGS, the increasing rate of flow exceeded the design capacity of the MGS.⁶ The flow likely exited the MGS at a number of points as shown in *Figure 1*, including the following:

1. *The main 12-in. gas vent line up the derrick:* This line directs separated gas to the top of the derrick, where it exits to the atmosphere through an angled rain deflector. The 12-in. vent line is not goose-necked and would have directed flow to the port side of the rig.⁷ See *Figures 1 and 3*.
2. *The 10-in. return line to the gumbo box:* This line returns separated mud from the MGS into the gumbo box and then to the shale shakers. The MGS is rated for 2,000 gpm; when this is exceeded, the mud seal is pushed out and allows gas and liquids through the lines to the shaker house. Gas would have dispersed into the gumbo box and then into the shale shaker room. See *Figure 1*.

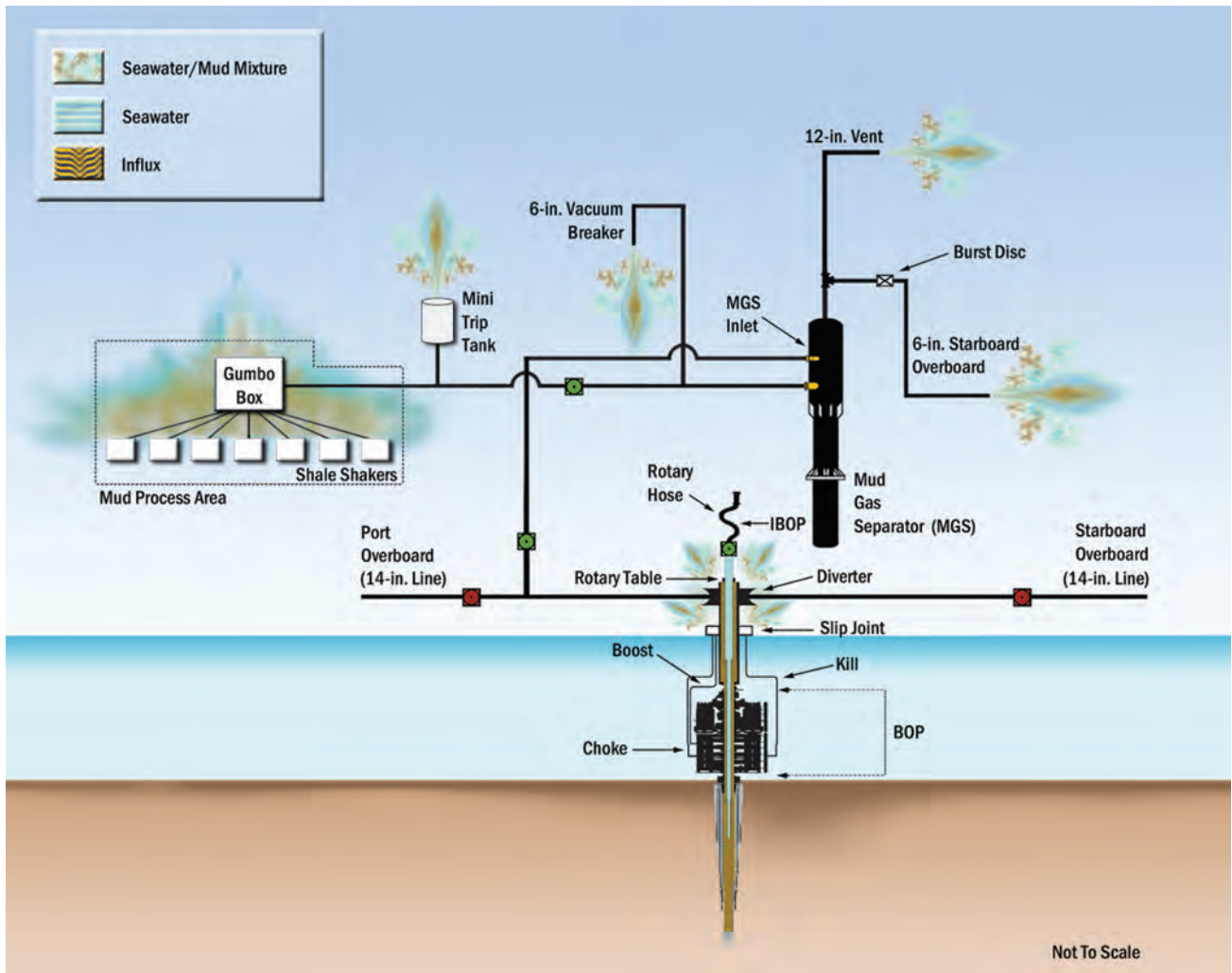

Figure 1 Gas Release Points

3. *The 6-in. pressure relief line:* This line protects the MGS from over-pressure by providing a relief flow path. It is activated by a rupture disk that gives way at 15 pounds per square inch (psi), directing flow overboard to starboard through a 6-in. line.⁸ The pressure relief rupture disk likely opened when mud was forced upward in the 12-in. gas vent line, increasing internal pressure in the MGS. The witnesses who reported seeing flow diverted overboard during the incident may have observed it exiting the relief line.⁹ See Figure 1.
4. *The 6-in. vacuum breaker:* This line runs up the back of the derrick and terminates with a 180-degree bend. When the MGS was overwhelmed, wellbore fluids were seen flowing from the vacuum breaker line gooseneck onto the aft starboard deck.¹⁰ See Figure 1.
5. *Mini trip tank connection:* When the mini trip tank receives excess mud during filling, it overflows into a 6-in. overflow line. When the MGS was overwhelmed, flow likely proceeded through the mini trip tank overflow line and exited the top of the tank onto the rig floor.^A See Figure 1.

A The mini trip tank is open to the atmosphere.

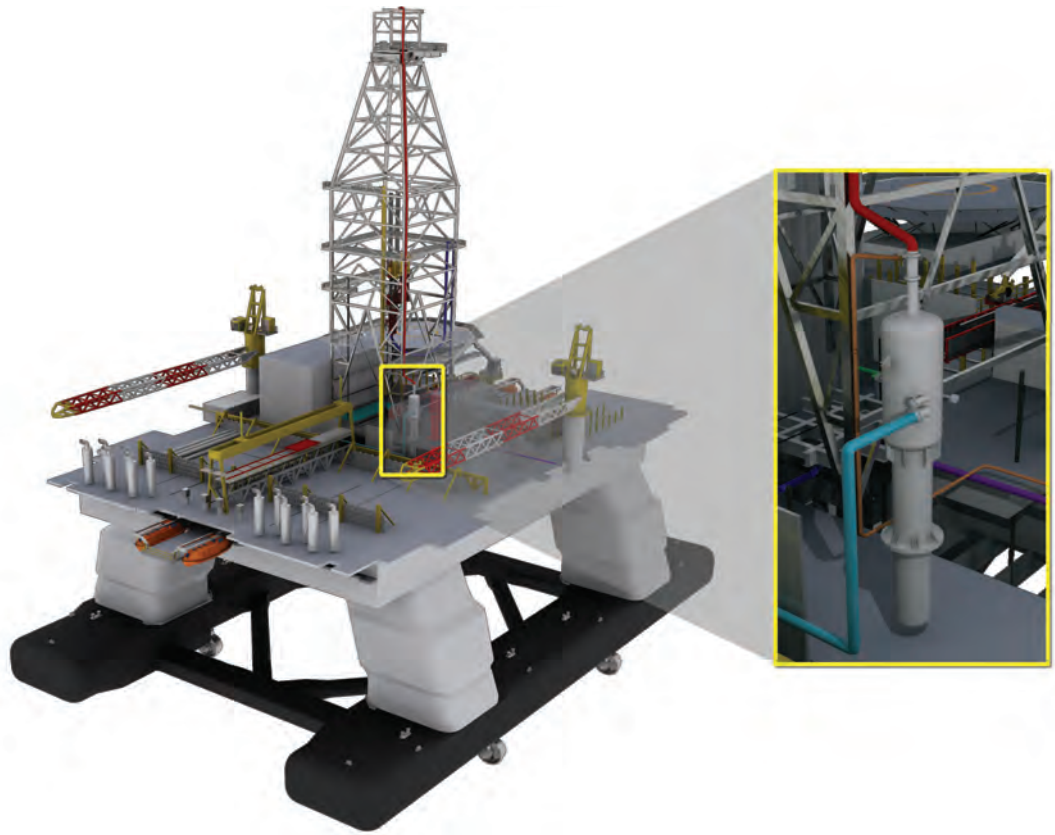

Figure 2 Location of Mud-Gas Separator



Figure 3 MGS 12-in. Vent Line at the Derrick Crown

Slip Joint

The slip joint (or telescopic joint) connects the drilling riser to the diverter housing located in the moon pool (the open hole between the drill floor and sea surface) under the rig floor. The slip joint is a flexible connection that allows the riser to stay connected to the rig by stroking in and out as the rig rises and falls with the sea. It is fitted with two mud seal packers, or seals, that can function at pressures of 100 psi and 500 psi, respectively.¹¹ The 100-psi packer is used for drilling operations, and the 500-psi packer is activated when either of the 14-in. diverter overboard valves opens. The investigation team analysis indicates that the pressure from the wellbore fluids in the riser overcame the sealing capability of the slip joint packers and provided a path for wellbore fluids and gas to exit into the moon pool.

Diverter

The diverter packer is contained within the diverter housing located directly under the rotary table on the rig floor. When activated, the diverter packer provides a seal around the drill pipe, preventing mud flow onto the rig floor as mud is directed from the diverter housing to the MGS or through the 14-in. diverter overboard valves and lines. The diverter packer unit pressure rating was 500 psi.¹² During the incident, fluids were observed flowing from the rotary, stopping briefly, and then starting to flow again.¹³ The investigation team analysis indicates that flow likely overcame the capacity of the diverter packer and provided a path for wellbore fluids and gas to exit onto the rig floor.

USE OF THE DIVERTER

The investigation team determined that the Transocean drill crew followed the standing protocol relating to diverting flow on April 20, 2010. Shortly after 9:40 p.m., the drill crew routed well returns to the trip tank to check for flow. Based on post-incident calculations, the flow-out rate from the riser at 9:41 p.m. was approximately 47 bpm. By 9:42 p.m., the trip tank began to fill and indicated to the driller that the well was flowing at a rate of 17 bpm, a flow rate within the capacity of the mud-gas separator. The flow likely overwhelmed the small line to the trip tank and would have produced a reading of a lower flow rate than what was actually exiting the riser at the time. Mud began to fill the diverter housing.

The drill crew closed the upper annular BOP element at 9:43 p.m. It has been determined that the BOP annular did not seal. Mud flowed onto the rig floor and then erupted to the top of the 215-ft.-tall derrick, covering the drill shack in oily mud and sea water. After activating the diverter at 9:45 p.m., the drill crew activated the variable bore rams, which sealed by 9:47 p.m. The drill pipe pressure increased as would be expected when the variable bore rams sealed.

The actions of the drill crew to divert and close the variable bore rams in quick succession after fluid erupted from the riser indicates their actions were consistent with Transocean training to attempt to regain control of the well.

Impact of Environmental Conditions and Wind Direction

Environmental conditions, particularly wind speed and direction, often have a significant impact on the migration and dispersion of gas in open areas. At the time of the incident, the *Deepwater Horizon* was on a 135-degree southeast heading with a slight breeze from the southwest at 227 degrees blowing starboard to port at approximately 3 knots.¹⁴ See Figure 4. These weather conditions did not significantly impact the migration and dispersion of gas; because of benign ambient wind condition, gas did not disperse on the aft deck and therefore reached the ventilation intakes to internal spaces such as engine rooms 3 and 4.

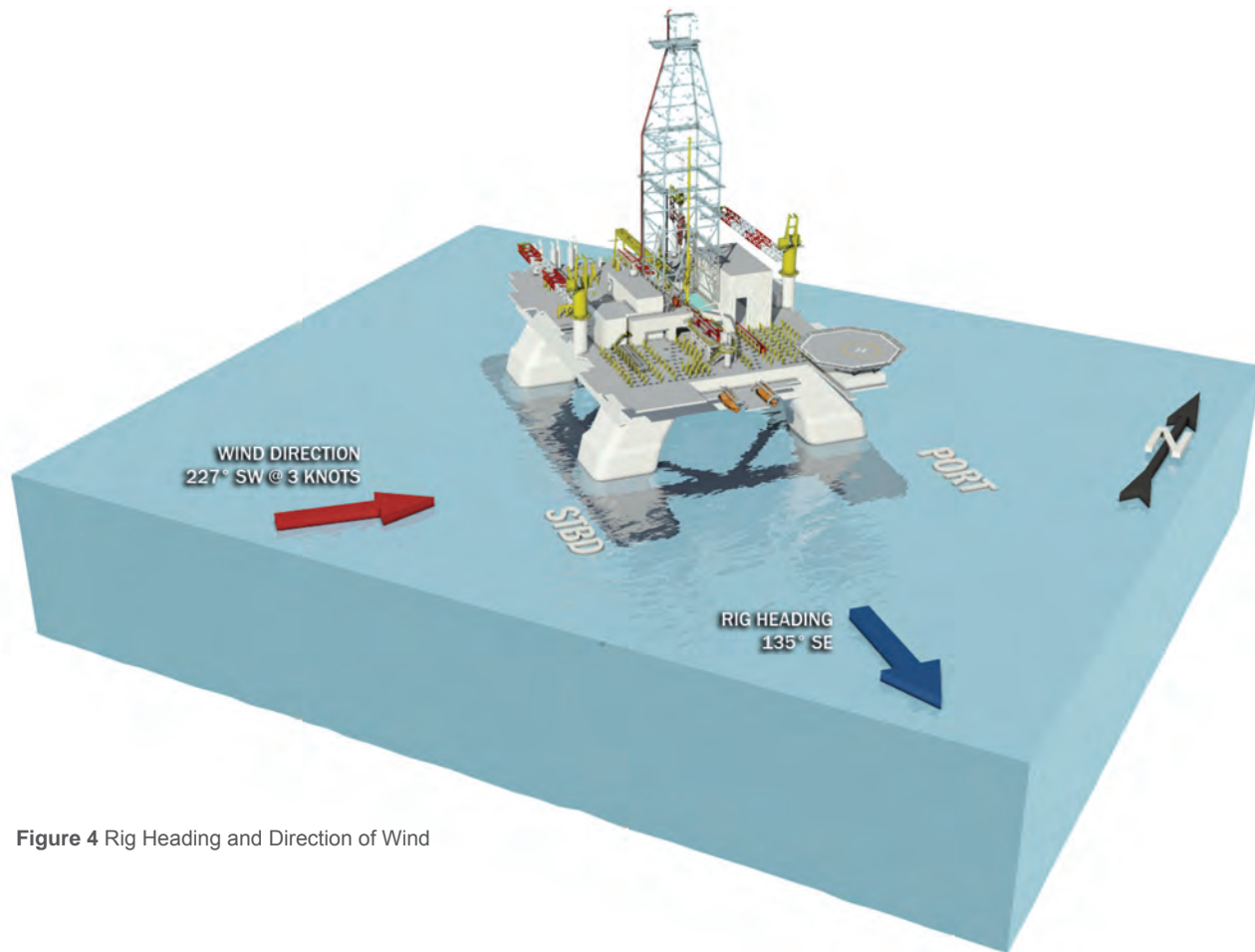

Figure 4 Rig Heading and Direction of Wind

3.5.2 Fire and Gas Detection System

The *Deepwater Horizon* fire and gas detection system was designed, installed, and maintained to comply with applicable regulations.¹⁵ This compliance was verified independently by the American Bureau of Shipping (ABS) during Mobile Offshore Drilling Unit (MODU) code surveys, and by the Minerals Management Service (MMS) and the U.S. Coast Guard (USCG) during their periodic inspections.¹⁶

The *Deepwater Horizon* fire and gas detection system worked as designed on the night of April 20, 2010. The system detected the presence of hydrocarbon gases in various areas around the rig and alerted the bridge team and personnel in the engine control room.¹⁷ The bridge team called areas where gas was detected, sounded the general alarm, and made public address (PA) announcements ordering the drill crew to the emergency muster stations.¹⁸

Fire and Gas Detection System Components

The rig fire and gas detection system was integrated with other rig systems that support various emergency responses, including the audio and visual alarm systems, the PA system, the emergency shutdown (ESD) system, and the heating ventilation and air conditioning (HVAC) system.¹⁹

The fire and gas detection system had numerous components that included 565 automatic sensors and manual fire alarm stations located throughout the rig.²⁰ See Figures 6–10. The system could be controlled and monitored at different locations. See Figure 11. The fire and gas detection system also included the following:

- *Multiple operator stations:* Located on the bridge, the driller's work station (DWS), the cement room, the sack room, and the engine control room. The rig had five separate operator stations such that the crew could monitor and control the fire and gas detection systems from different areas of the rig. See Figure 11.
- *Multiple control panels:* Located on the bridge, in the engine control room, and at the DWS. Each of the control panels provided the real-time status of the fire and gas detection system and was capable of starting the fire pumps and the helideck foam pump. The bridge housed three types of control panels: the ESD system, the Simrad Safety System (SSS), and the Simrad Vessel Control (SVC). See Figure 11.
- *Redundancy:* The system included a fully redundant communications network and system of electronic controllers designed so that the potential failure of an individual component would not adversely affect the functionality of the rest of the system.

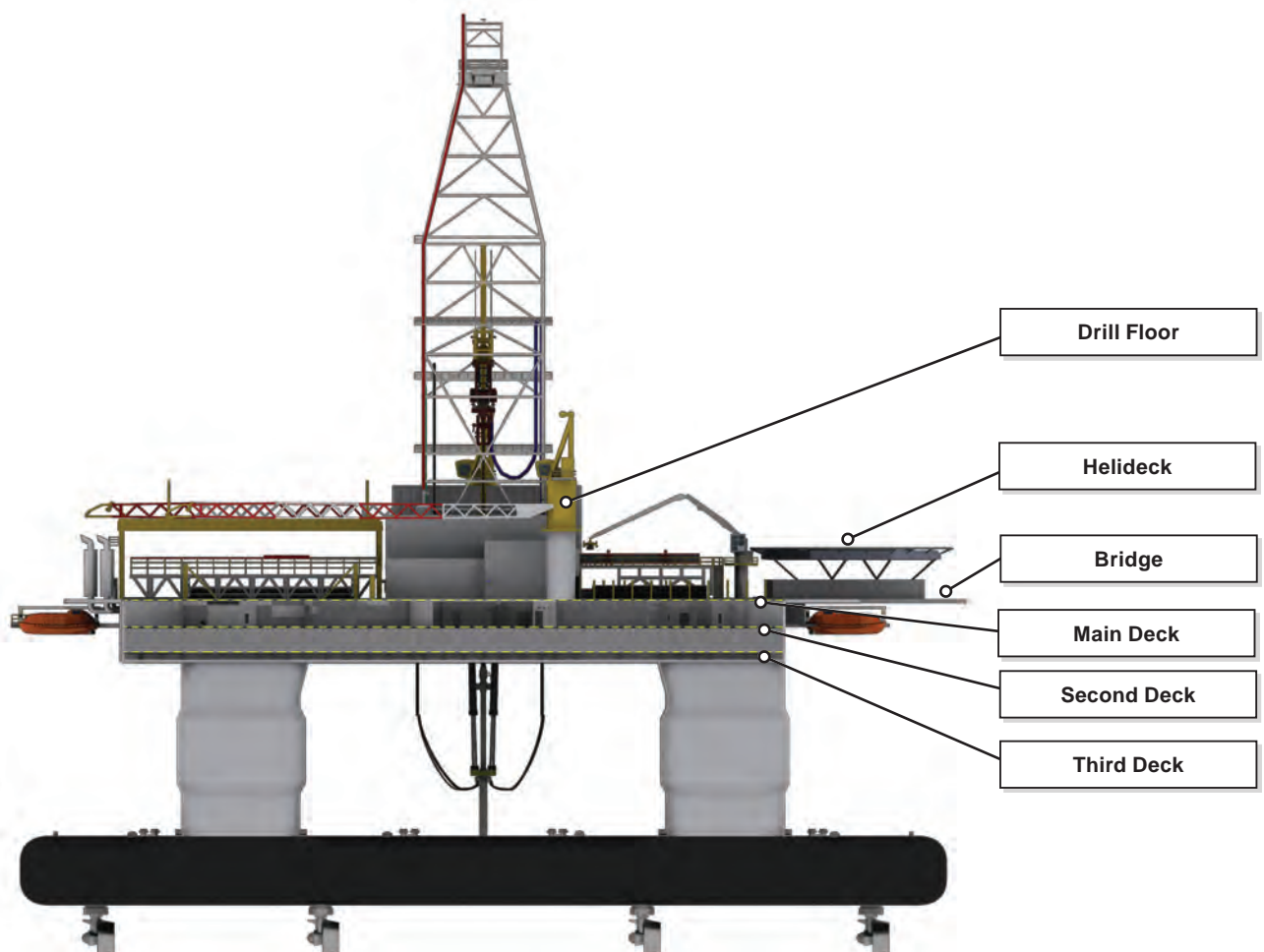

Figure 5 Deck Levels on the *Deepwater Horizon*

The 565 field sensors, detectors and manual alarm stations located throughout the *Deepwater Horizon* included:

- 349 smoke detectors
- 23 thermal sensors
- 15 infrared flame detectors
- 126 manual (“pull in case of emergency”) alarm stations
- 27 combustible gas detectors
- 25 toxic (H_2S) gas detectors

See Figures 6–10 for field sensor locations; Figure 5 indicates the *Deepwater Horizon* deck levels.

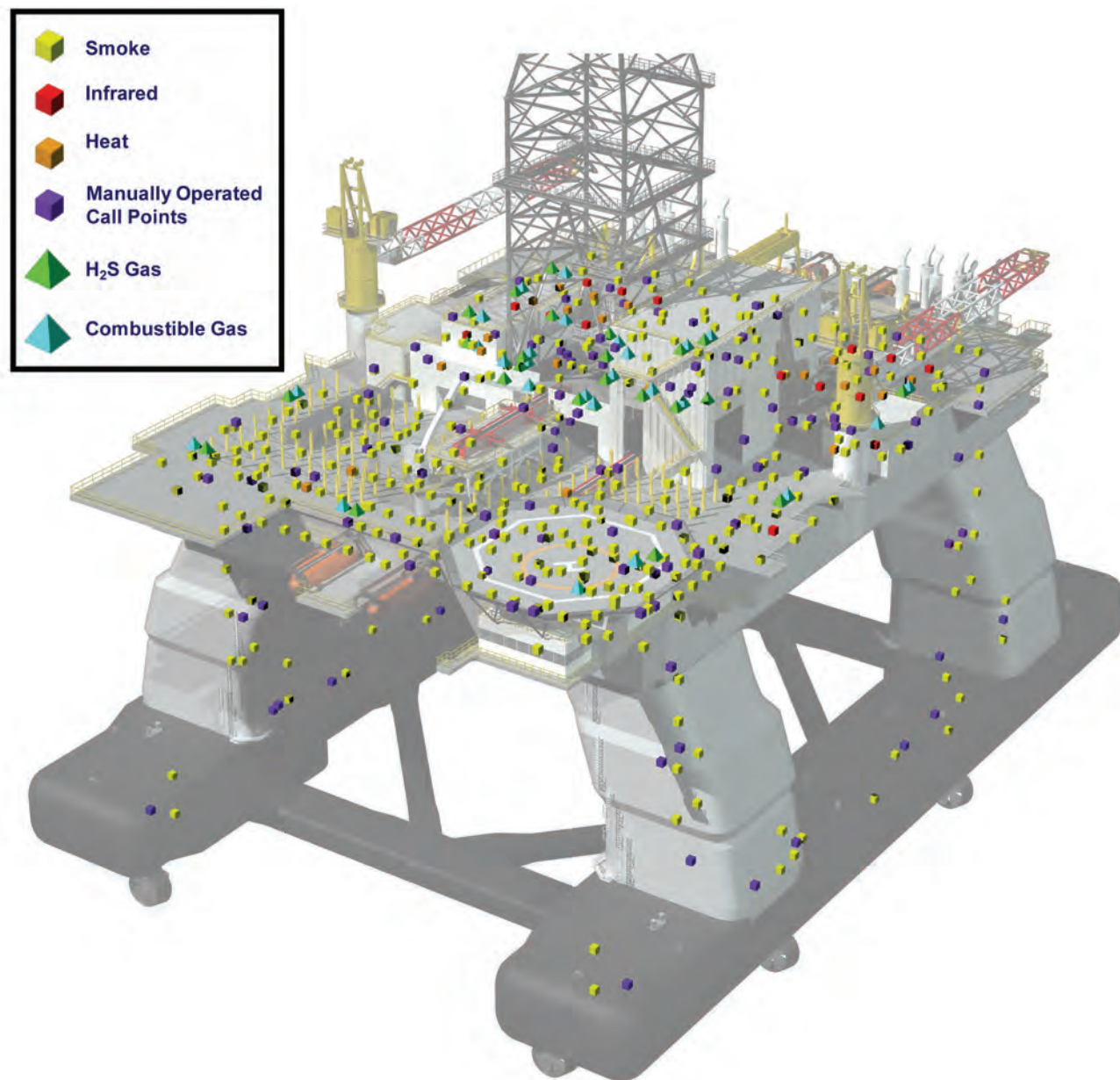

Figure 6 Automated Sensor and Manual Call Point Locations throughout the Rig

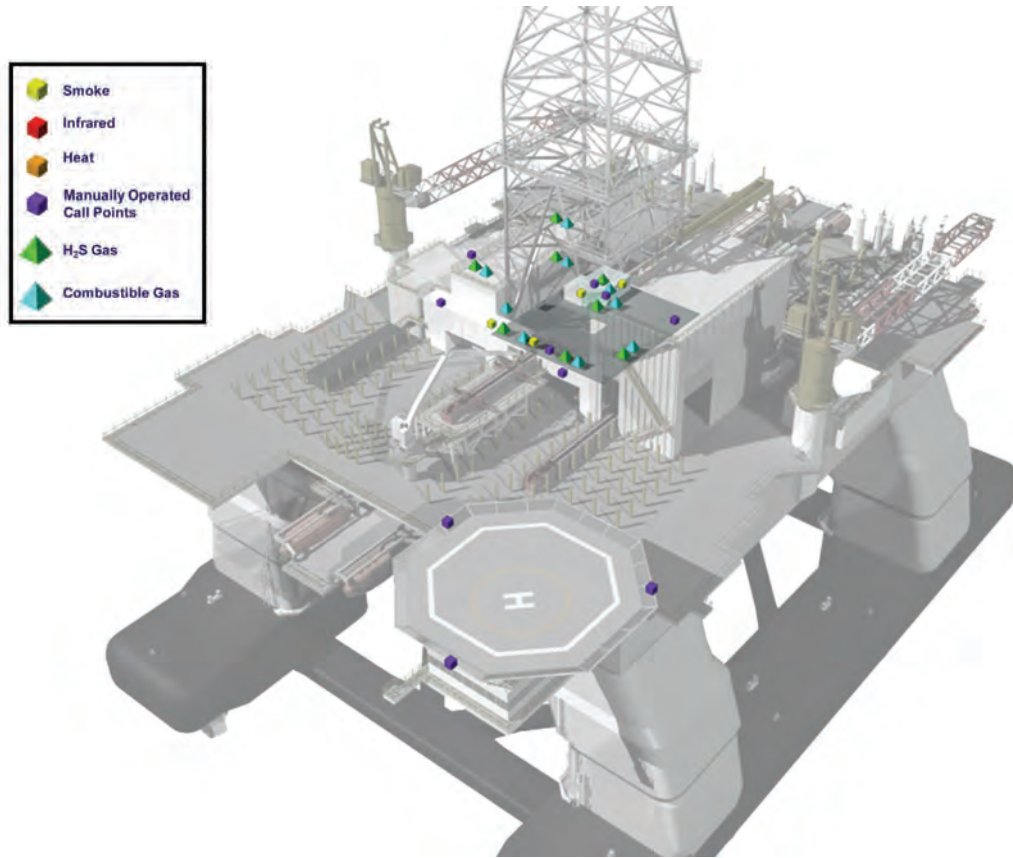

Figure 7 Automated Sensor and Manual Call Point Locations on the Drill Floor and Helideck

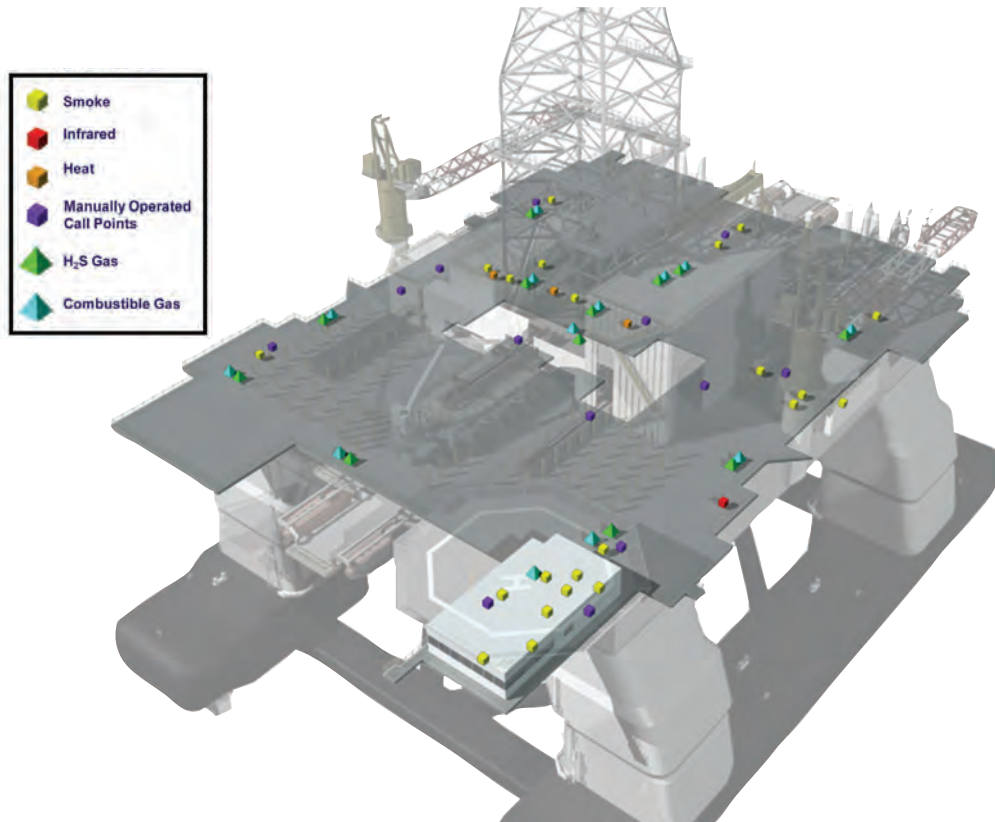

Figure 8 Automated Sensor and Manual Call Point Locations on the Main Deck

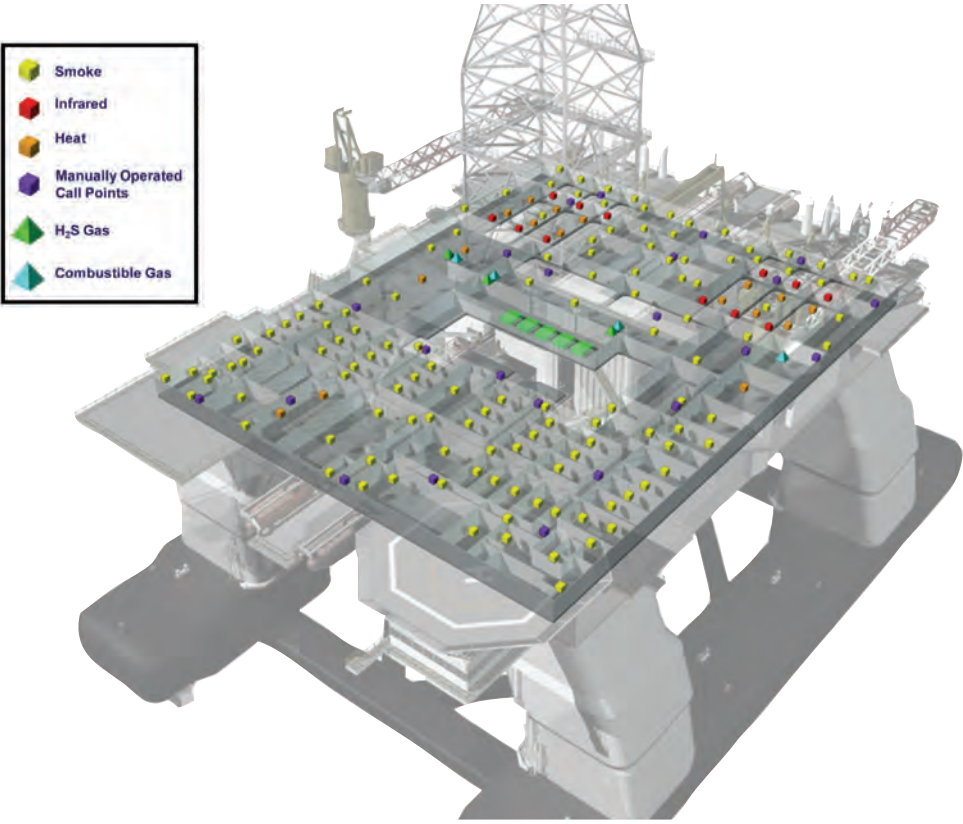

Figure 9 Automated Sensor and Manual Call Point Locations on the Second Deck; Green Blocks Represent the Shale Shakers

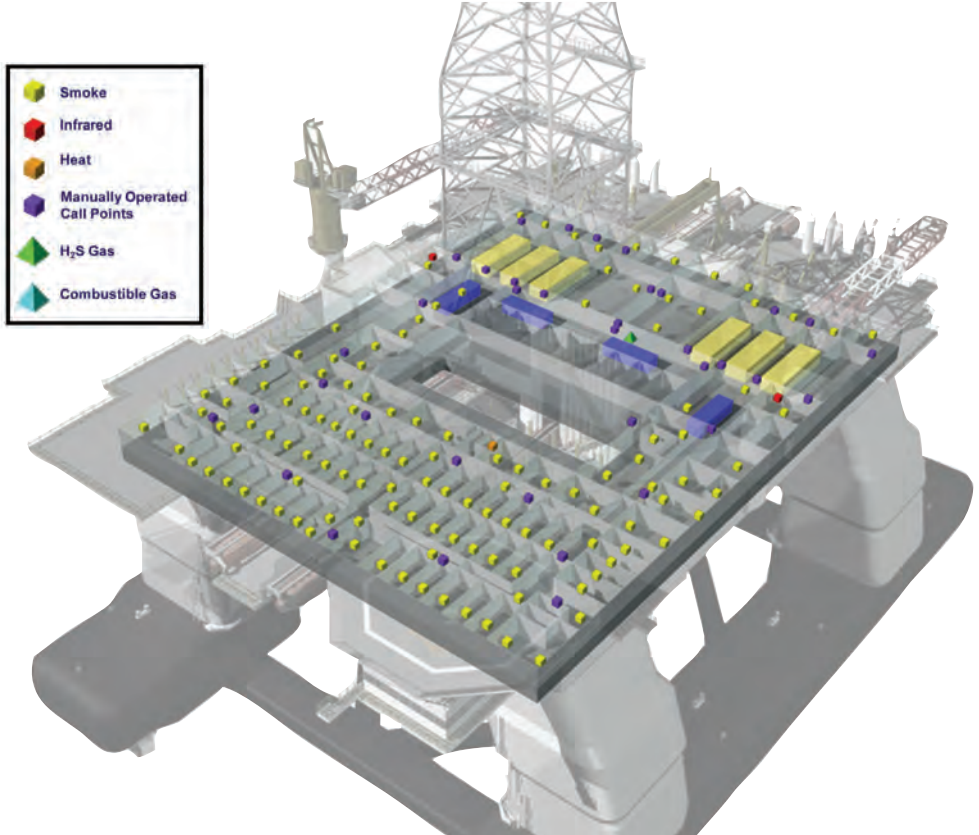

Figure 10 Automated Sensor and Manual Call Point Locations on the Third Deck; Yellow Blocks Represent the Engine/Generator Rooms; Blue Blocks Represent the Mud Pumps

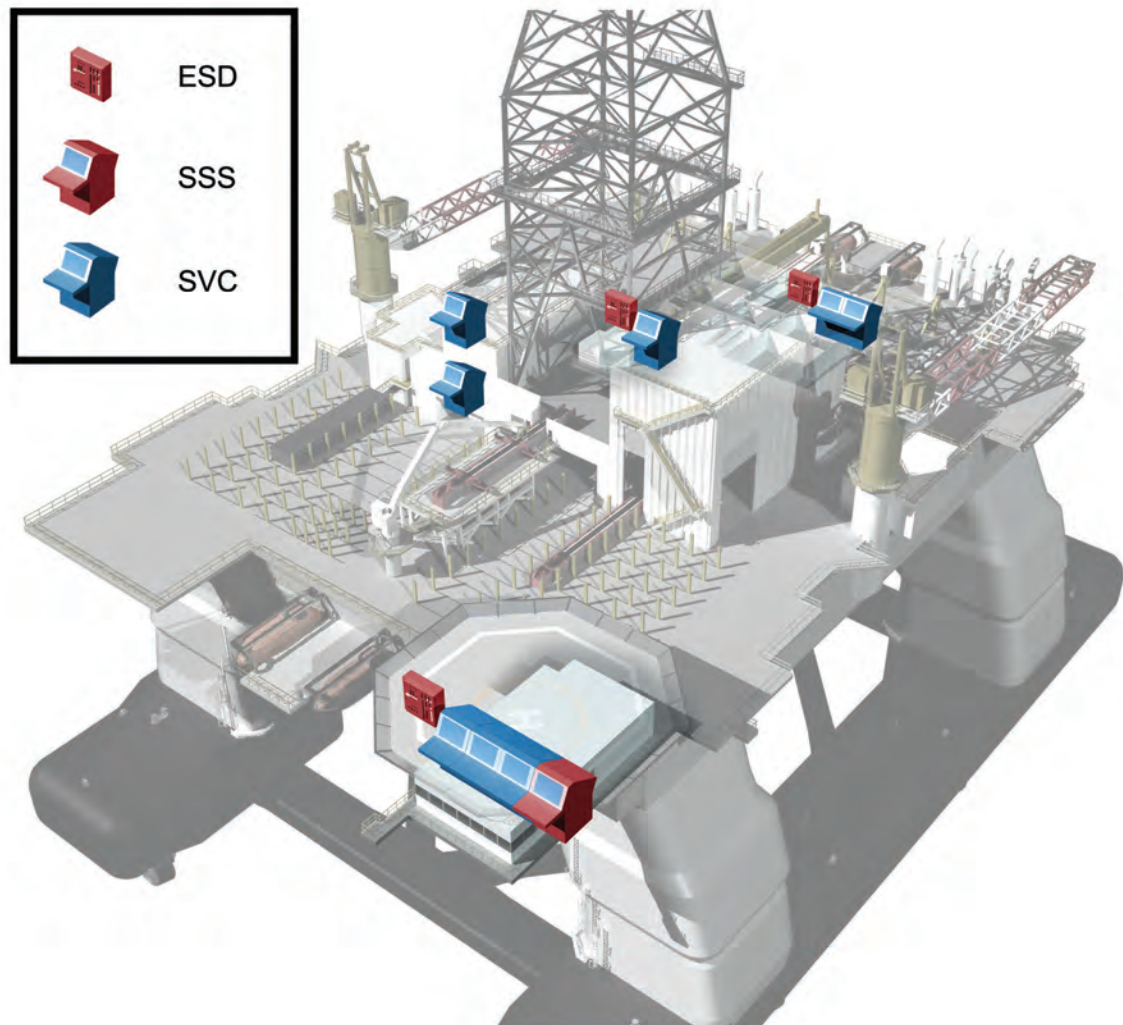

Figure 11 Alarm Indication Panels on the *Deepwater Horizon*

Fire and Gas Detection System Monitoring

Dynamic positioning operators (DPOs) monitored the fire and gas detection system from the bridge 24 hours a day.²¹ As outlined above, other members of the crew also could monitor and operate the system at other locations on the rig as needed. See *Figure 11*. All personnel on the rig were authorized to activate the fire alarm and notify the bridge upon detecting a fire or other hazard.²²

When an alarm sounded at the fire and gas operator station, the detector module symbol on the control panel would begin flashing and the status lamp would activate on the main display. The fire or gas indication lamp on the panels on the bridge, in the engine control room, and at the DWS also would start to flash on the SVC. See *Figure 11*.

On April 20, 2010, Transocean personnel on the bridge followed the prescribed operating procedure for responding to an alarm, which is summarized as follows:²³

1. The alarm is acknowledged by the DPO on bridge watch.
2. The DPO directs other personnel to investigate the cause of the alarm and to report back. If the alarm is in a manned space, the DPO phones the location to warn any personnel present. If the alarm is verified, the DPO instructs all personnel to leave the affected area.
3. A PA announcement is made, the general alarm is activated manually, and emergency shutdown actions may be initiated.

Fire and Gas Alarms and Dynamic Positioning Systems

The *Deepwater Horizon* fire and gas system was continuously monitored by a DPO and required manual intervention to trigger the general alarm. The sounding of the general alarm on the rig required manual activation, consistent with USCG requirements.²⁴

The occurrence of false alarms pose significant safety problems on a rig; they increase the risk of injuries, cause interruptions to operations, and can lead to what is known as “alarm fatigue.” For example, smoke detectors, which operate not by specifically identifying smoke in the air but rather by detecting any small particles (e.g., soot, dust, cement, steam, water vapor, and sand particles), are prone to triggering frequent false alarms when the system is in automatic mode. Likewise, sensors on the exterior of the rig can trigger alarms due to their exposure to the elements. If these false alarms were to sound regularly, as has been the case when marine alarm systems are set in automatic mode, crew responsiveness would be likely to decline and injuries would be likely to increase. The manual activation system prevents this “alarm fatigue” problem, assuring that the alarms will continue to be heeded.

The emergency shutdown (ESD) system aboard *Deepwater Horizon* also required manual activation. By design, the fire and gas detection system did not initiate automatic actions to shut down ventilation to the engine generator rooms because the *Deepwater Horizon* was a dynamically positioned (DP) vessel. A DP vessel requires power for its station keeping system and thrusters to maintain its position.²⁵ Without power, the rig would lose its ability to stay in position and thus drift off location. A powerless, drifting rig is a serious hazard to personnel onboard, as well as to those on nearby vessels. It can also have significant environmental consequences if the drifting rig pulls against the BOP through the riser (e.g., breaking the riser, or toppling or damaging the BOP). Because of the risks posed by the rig’s loss of power, the fire and gas detection and ESD systems are designed to require manual rather than automatic activation to shut down critical systems once the alarms went off.²⁶

3.5.3 Hazardous Areas

Rig design takes into account the potential for an explosive gas/air mixture in each area. Areas with a high probability or possibility were classified as “hazardous.” The main hazardous areas on the *Deepwater Horizon* were the drill floor, derrick, moon pool, and associated drilling process areas, such as the shale shaker and mud pit rooms. See *Figures 12–15*. The majority of the *Deepwater Horizon* was classified as non-hazardous. The hazardous areas on the *Deepwater Horizon* complied with ABS classification, flag state, and international standards.²⁷

Electrical equipment within the hazardous areas was designed and maintained to prevent potential ignition sources. Such equipment met international standards and was inspected independently as part of the rig’s ABS classification and MODU code requirements. Due to the large volume of hydrocarbon fluids escaping the well during the incident, it is almost certain that gas migrated to non-hazardous areas where equipment did not require ABS classification.²⁸

Rig areas are divided into three zones based on the possibility that each could contain an explosive gas/air mixture.²⁹ These zones are:

- Zone 0: Explosive gas/air mixture is continuously present or present for long periods of time. There were no Zone 0 areas on the *Deepwater Horizon*.
- Zone 1: Explosive gas/air mixture is likely to occur during normal operations.
- Zone 2: Explosive gas/air mixture is not likely to occur or, if it does occur, will exist only for a short period of time.

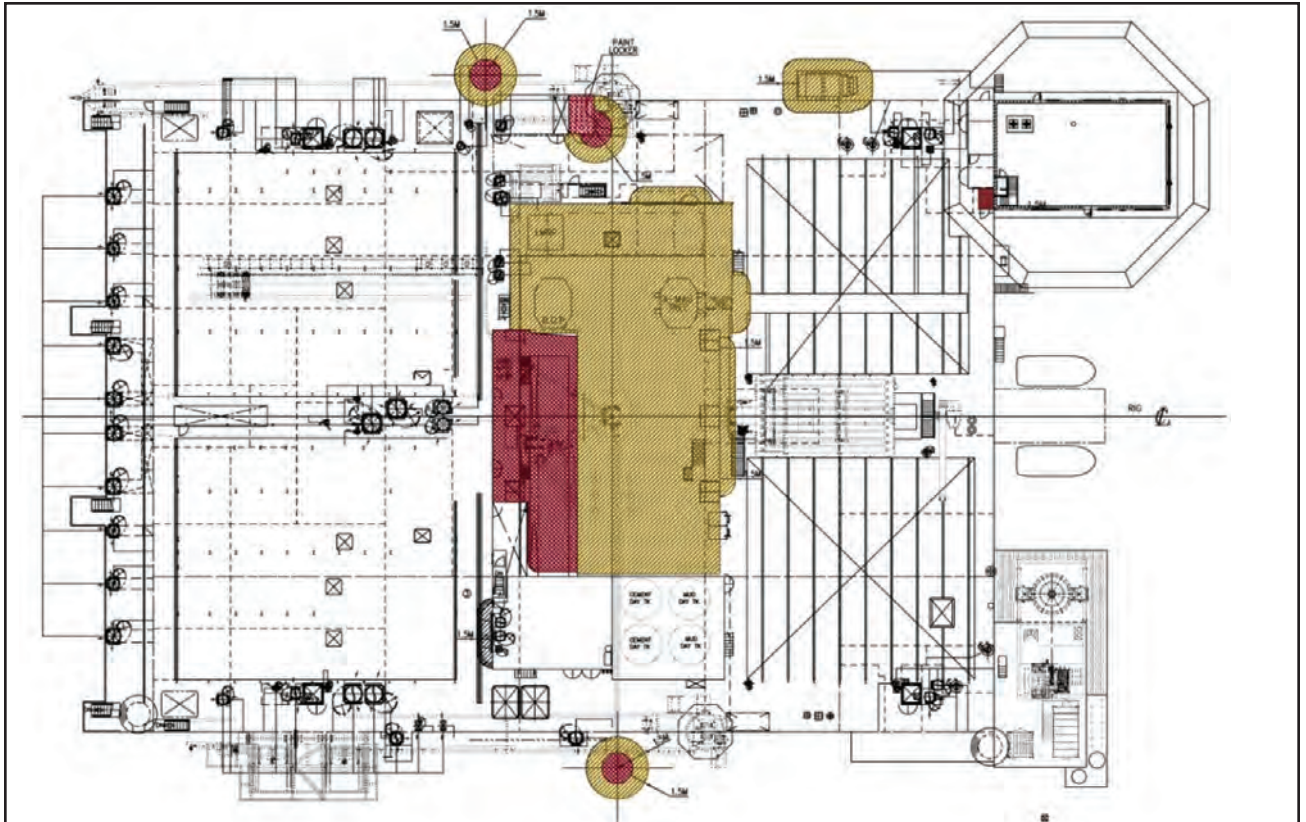

Figure 12 Main Deck Zone 1 - Red, Zone 2 - Yellow

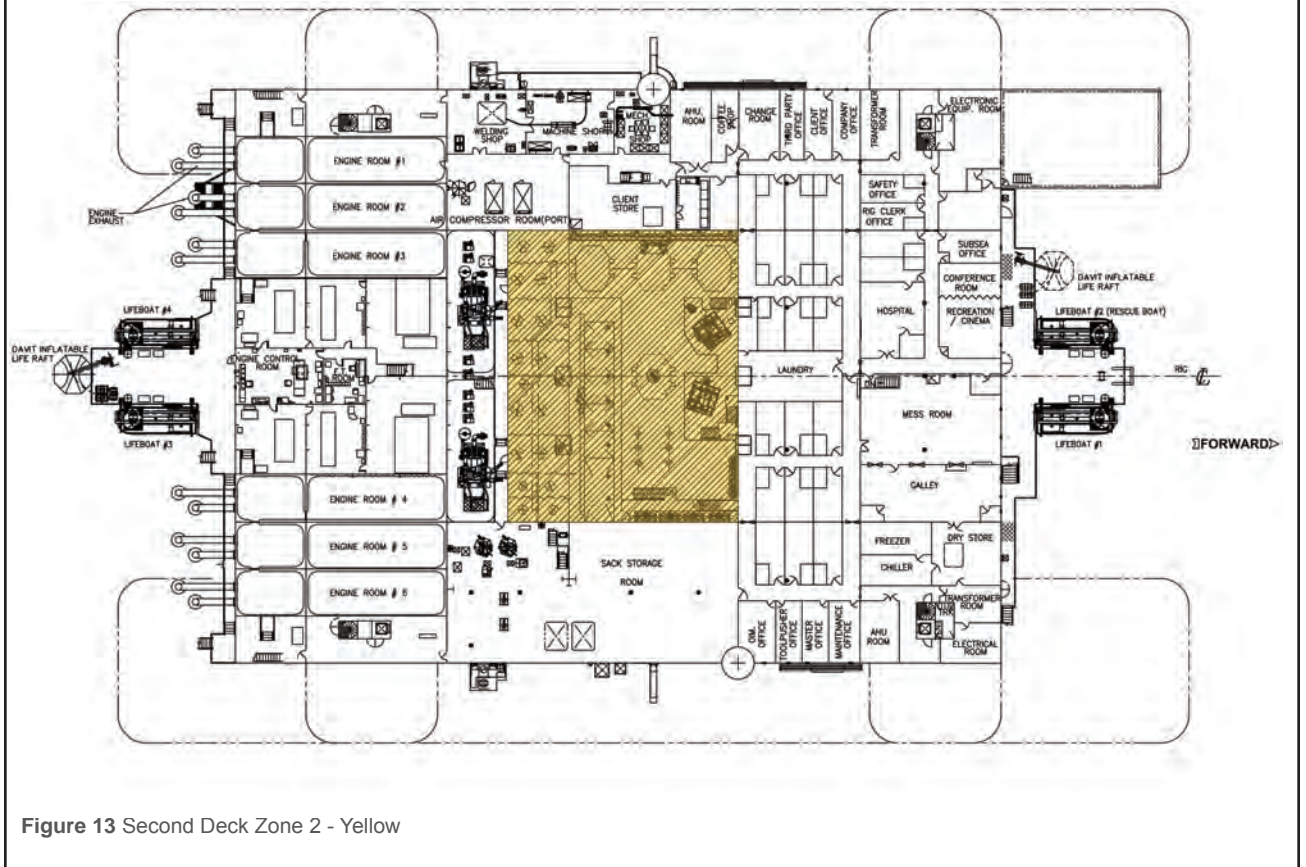

Figure 13 Second Deck Zone 2 - Yellow

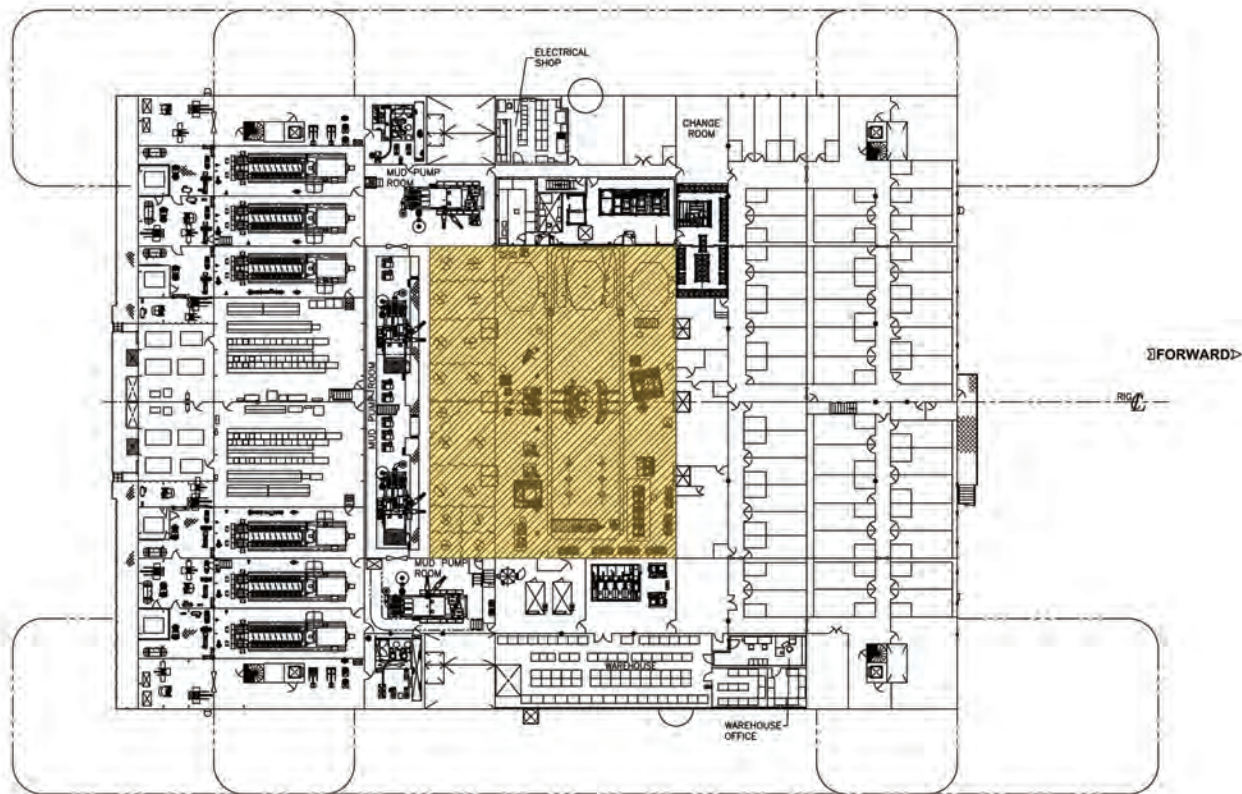

Figure 14 Third Deck Zone 2 - Yellow

The heating, ventilation and air conditioning (HVAC) system on the *Deepwater Horizon* played an important role in ensuring the safety of personnel by:

- Preventing gas from entering the accommodation areas
- Evacuating any gas that entered hazardous areas such as the shale shaker room
- Maintaining air for power generation to keep the rig on the drilling location

The HVAC system on the *Deepwater Horizon* had a number of constituent parts.³⁰ The HVAC system was interconnected with the fire and gas detection system and emergency shutdown (ESD) system.³¹ The HVAC system was maintained under the *Deepwater Horizon* planned maintenance system and was independently inspected by ABS for rig classification and to ensure compliance with its MODU code requirements. It also was inspected separately by the MMS.³² The principal ventilation inlets and exhaust for areas (excluding the living quarters) are shown in *Figures 16 and 17*.

By design, the fire and gas detection system did not initiate automatic actions to shut down ventilation to the engine generator rooms because the *Deepwater Horizon* was a dynamically positioned vessel.

DPO monitored the ventilation system to identify failures in those areas of the *Deepwater Horizon*, such as the mud pit room, where positive or negative pressure must be maintained to control migration of potentially hazardous gas levels into non-hazardous areas. If a loss of pressure was detected, an alarm sounded on the safety panel on the bridge to alert the DPO to initiate the alarm response procedure.

Living Quarters (Accommodations)

The living quarters were not designated as a hazardous area, and the location of the ventilation supply fans for this area were not located within a hazardous area. As such, the HVAC system in the living quarters was

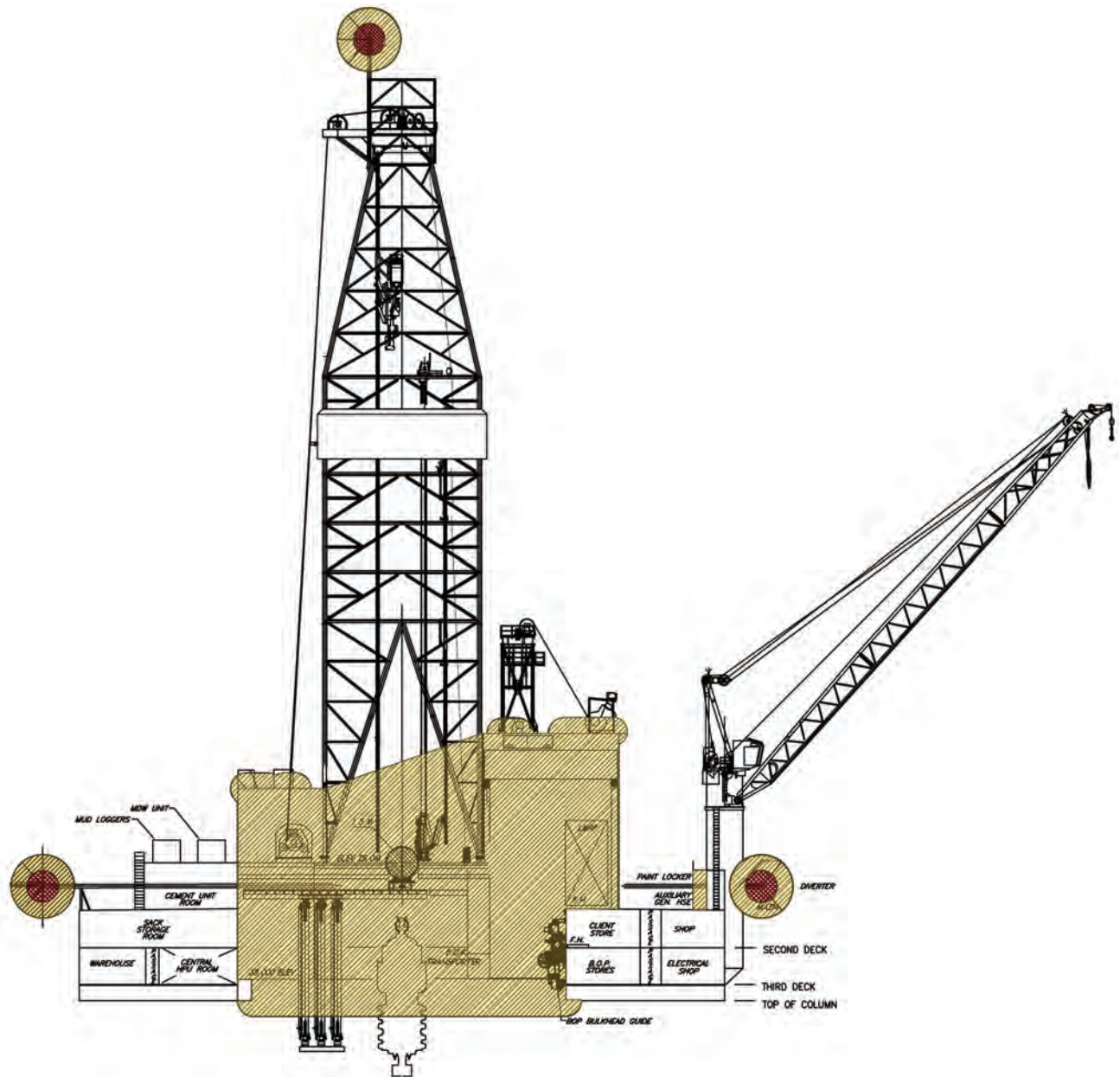

Figure 15 Drill Floor and Derrick Zone 1 - Red, Zone 2 - Yellow

designed to shut down ventilation inlet dampers and to stop the ventilation fans automatically upon detection of gas.³³ The investigation team believes that the HVAC system in the living quarters shut down as designed.

Engine Rooms

The engine rooms were not designated as hazardous areas, and the location of the ventilation supply fans for these rooms also were not located within a hazardous area. See Figure 12. The investigation team believes that, at the time of the incident, both the supply and exhaust fans for all six engine rooms were running in accordance with normal operating practice. Numerous gas detectors activated prior to the initial explosion, but there is no evidence that clearly indicates gas detectors in the engine rooms detected the presence of gas.³⁴ Due to the magnitude of the gas release, however, it is suspected that the detectors for engine rooms 3 and 4 would have detected gas. There are reports from personnel in the ECR of seeing emergency shutdown (ESD) lights flashing before loss of main power, but the investigation team has been unable to establish whether any of the engine room ventilation systems was shut down.³⁵

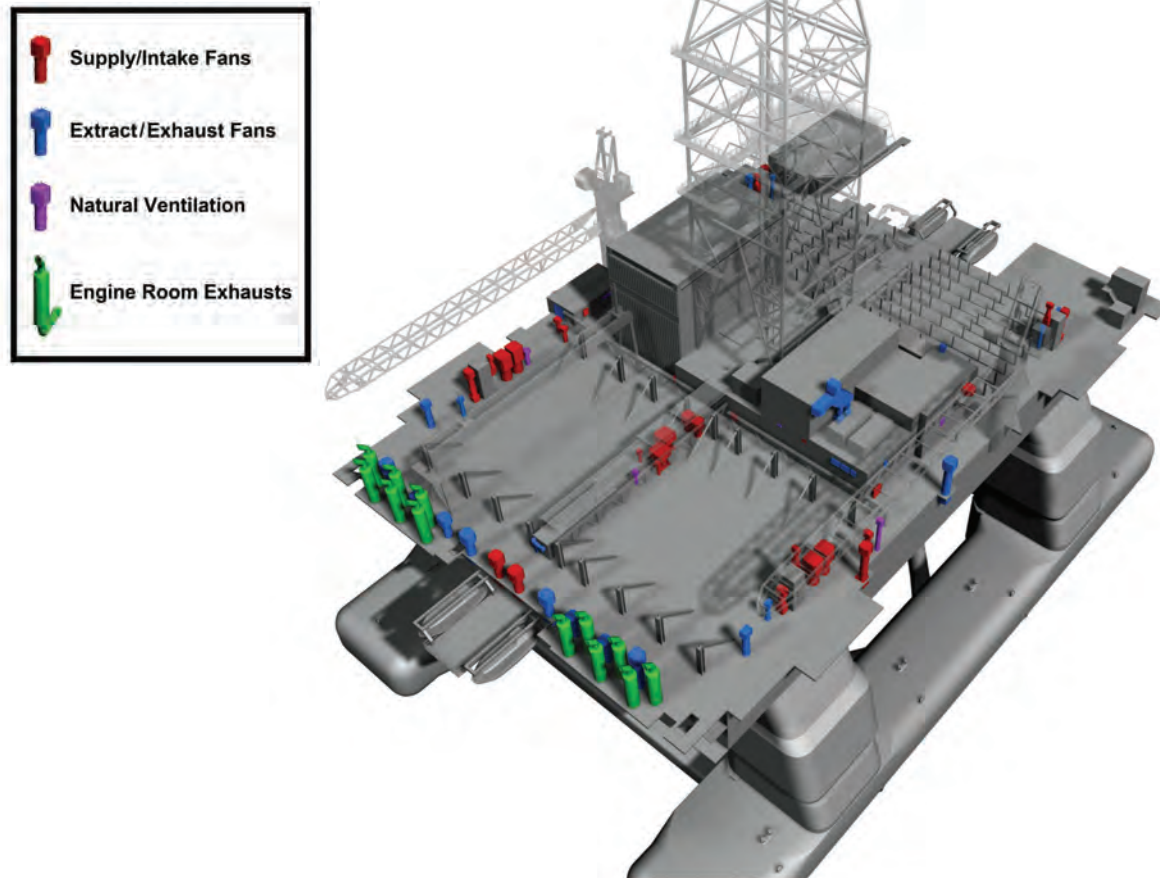

Figure 16 Principal Ventilation Inlets and Exhaust (Viewed from Starboard Aft)

Mud Pit Room

The mud pit room was designated a Zone 2 hazardous area, but the ventilation supply fans for this room were not located within a hazardous area. See Figure 12. The investigation team believes that, at the time of the incident, both the supply and exhaust fans for the mud pit room were running in accordance with normal operating practice. Numerous gas detectors activated prior to the initial explosion, but there is no evidence clearly indicating that gas detectors in the mud pit room detected the presence of gas. Due to the magnitude of the gas release, however, it is suspected that gas was drawn into the room.³⁶ As a designated hazardous area, the ventilation was not designed to shut down automatically.³⁷

Mud Pump Room

The mud pump room was not designated as a hazardous area, and the ventilation supply fans for this area were not located within a hazardous area. See Figure 12. The investigation team believes that, at the time of the incident, both the supply and exhaust fans for the mud pump room were running in accordance with normal operating practice. Due to the magnitude of the gas release, however, it is suspected that gas was drawn into the room.³⁸

Shale Shaker Room

The shale shaker room was designated a Zone 1 hazardous area, but the ventilation supply fans for this room were not located within a hazardous area. See Figure 12.

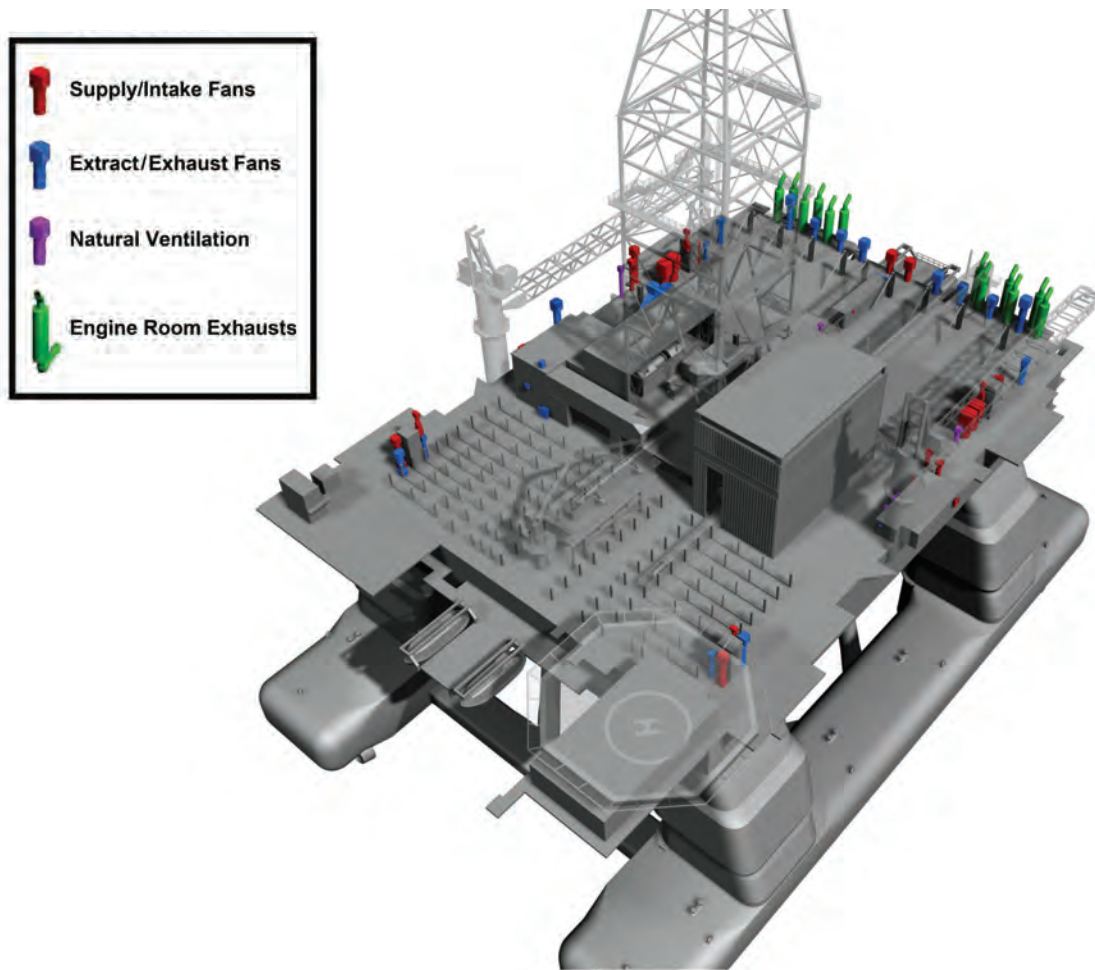

Figure 17 Principal Ventilation Inlets and Exhaust (Viewed from Port Forward)

The investigation team believes that, at the time of the incident, both the supply and exhaust fans were running in accordance with normal operating practice. The gas alarms activated in the shale shaker area at about 9:47 p.m.³⁹ As a designated hazardous area, the ventilation in the shale shaker room was not designed to shut down automatically.⁴⁰ Instead, the system was designed to sweep gas from the room by exhausting gas/air mixture from the room while replacing it with fresh air.⁴¹

Driller's Work Station (DWS) and Driller's Equipment Room (DER)

The DWS and DER were located within the perimeter of the derrick, a Zone 2 hazardous area. The DWS and DER were equipped with a purge and pressurization system. The purge system was designed so that the contents of these spaces were "safe" within the Zone 2 area. The DWS and DER had two fully redundant pressurization fans providing 100% redundancy, with the second fan starting automatically upon failure of the lead fan.⁴² Ventilation supply fans for these spaces were located outside of a hazardous area. *See Figure 12.* The investigation team has not been able to verify whether the systems operated as designed on the day of the incident but has found no evidence that they did not.

The BOP – Driller's Control Panel (DCP) Operated in "Bypass" Mode

Prior to the incident, there was a component failure in the purge system for the driller's BOP control panel. However, a replacement system from the manufacturer could not be installed while the BOP was still deployed to the seabed because of the risks associated with such an operation; instead, it would be installed at the next maintenance period, when drilling was completed and the BOP was recovered from the seabed.⁴³

To compensate for this component failure, the purge/pressurization system for the driller's BOP control panel operated in "bypass" mode to prevent a power loss to the BOP control panel at a critical time.⁴⁴ In the "bypass" mode, the panel constantly was purged and pressured with air. The DCP, located within the DWS, was deemed safe to operate and, therefore, would not have had any effect on the driller's ability to control or operate the BOP.

3.5.4 Ignition

The size of the flammable gas cloud that enveloped the *Deepwater Horizon* made an explosion inevitable. While the investigation team cannot specify what source or sources caused the gas to ignite, the team has identified and analyzed possible ignition sources. They include:

- Engine spaces
- Main deck
- Drilling areas
- Moon pool area
- Mud pump/mud pit areas
- Shale shaker area
- Off rig

See *Appendix Q* for a complete discussion on the investigation team's review and analysis of possible ignition sources.

Engine Spaces (Likely)

Based on a gas dispersion analysis, a flammable gas mixture entered engine rooms 3 and 4 through the engine room ventilation intake fans.⁴⁵ The engine room ventilation dampers are controlled manually to prevent dangerous negative pressure conditions and sudden power loss, which would compromise the ability of the dynamically positioned rig to stay on location. When manually activated in response to an indication of low levels of gas, the dampers can provide a barrier to further gas intrusion.

Once inside the engine rooms, it is likely that gas may have ignited from a number of sources. Several components in the engine rooms may have generated sparks as the engines operated. Moreover, some witnesses reported hearing the engines "revving up" prior to the loss of power, possibly indicating that the engines were consuming the gaseous vapors as an uncontrolled fuel.⁴⁶ In this scenario, engines might trip off due to reverse power, over-frequency, or over-speed conditions, which would cause the power management system on the rig to start other engines that were on standby. The shutting down and starting up of the engines, as well as their connection and disconnection to the electrical buss, would generate additional possible ignition sources. Finally, the increase in exhaust temperature caused by an over-speeding engine could be an ignition source in a gas-laden environment.⁴⁷

Main Deck (Possible)

Based on witness statements and analysis, as gas dispersed widely over the aft deck of the *Deepwater Horizon*, it could have been ignited from a number of locations, the most likely source being the starboard crane engine.⁴⁸ Ignition on the main deck was possible, but given the information available, the investigation team was unable to determine an exact ignition source on the main deck.

Drilling Areas (Possible)

While the drilling areas on the *Deepwater Horizon* were classified as Zone 2 hazardous areas and would have contained explosion-proof equipment in compliance with ABS rules, foreign objects or damage caused by the blowout could have ignited the gas cloud in those locations.⁴⁹ Based on witness statements and analysis, gas dispersed across the drilling areas. Given the information available, the investigation team was unable to determine an exact ignition source in the drilling areas. Ignition within this area was possible; however, the gas concentration likely was above its flammable limit and too rich to ignite before the first explosion.

Moon Pool Area (Possible)

The moon pool was classified as a Zone 2 hazardous area and contained only equipment in compliance with ABS rules. Based on witness statements and a gas dispersion analysis, it is probable that gas entered the moon pool area through the slip joint packer.⁵⁰ It is possible that gas ignited from sparks caused by debris flying into the area and damaging equipment. It is known that there was a large fire within the moon pool at the time the chief engineer attempted to start the standby generator.⁵¹

Mud Pump/Mud Pit Areas (Possible/Unlikely)

The mud pit room was classified as a Zone 2 hazardous area and contained only equipment in compliance with ABS rules. The mud pump room was not classified as a hazardous area. Leading up to the incident, three of the four mud pumps were operational, and repairs to the fourth pump were being completed immediately prior to the explosions.⁵² Based on a gas dispersion analysis, gas entered the mud pump room and pit rooms.⁵³ Given the information available, the investigation team was unable to determine an exact ignition source in the mud pump/mud pit areas.

Shale Shaker Area (Unlikely)

The shale shaker area was classified as a Zone 1 hazardous area and contained explosion-proof equipment in compliance with ABS rules. Based on witness statements and a gas dispersion analysis, gas entered the shale shaker room.⁵⁴ Given the information available, the investigation team was unable to determine an exact ignition source in the shale shaker area. However, ignition within this area is thought unlikely because the gas concentration was above its flammable limit and too rich to ignite before the first explosion.

Off Rig (Unlikely)

There were two vessels in close proximity to the *Deepwater Horizon* at the time of the incident:

- The *Damon B. Bankston*, a supply vessel on hire to BP
- The *Endorfin*, a private fishing vessel

The only viable sources of ignition on the *Bankston* were her exhaust stacks, which were fitted with spark arrestors.⁵⁵ The absence of any report of an ignition stemming from the *Bankston* and only damage to a bridge window caused by an explosion from the *Deepwater Horizon* suggests that it was not an ignition source.⁵⁶ The *Endorfin* was reported to be 100 yards from the *Deepwater Horizon* at the time of the explosion, too distant to have caused ignition.⁵⁷ Although it cannot be stated definitively that another vessel was not a source of ignition, the investigation team believes that, on the balance of probabilities, it was not.

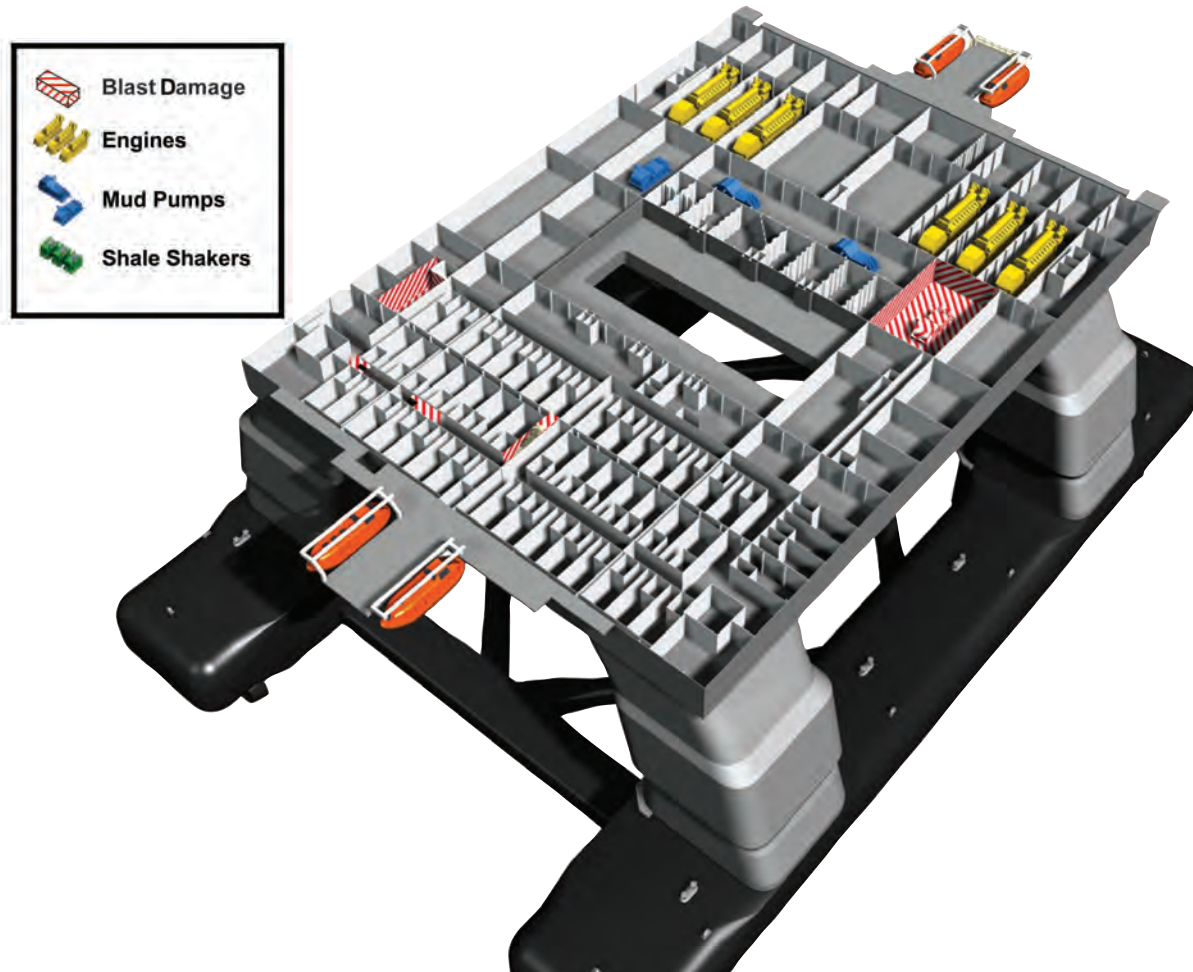

Figure 19 Blast Damage - Third Deck

3.5.5 Blast Damage

The investigation team has found no evidence that initial blast damage caused any significant impact to the primary structure of the *Deepwater Horizon*. Within the accommodations, where there was significant damage to offices, cabins, and common areas, the larger fixed items remained in place.⁵⁸ The explosions did cause blast damage to internal muster points, rendering them unavailable and hampered personnel transit to the forward lifeboats.⁵⁹ The blast damage had no materially adverse effects on the launching of the forward lifeboats and life rafts. See Chapter 3.6.

Based on witness statements, interviews, and hearing testimony, the investigation team has reconstructed the known damage caused by the initial explosions as represented in *Figures 18 and 19*.⁶⁰ There probably were additional damaged areas of the rig for which no information is available.

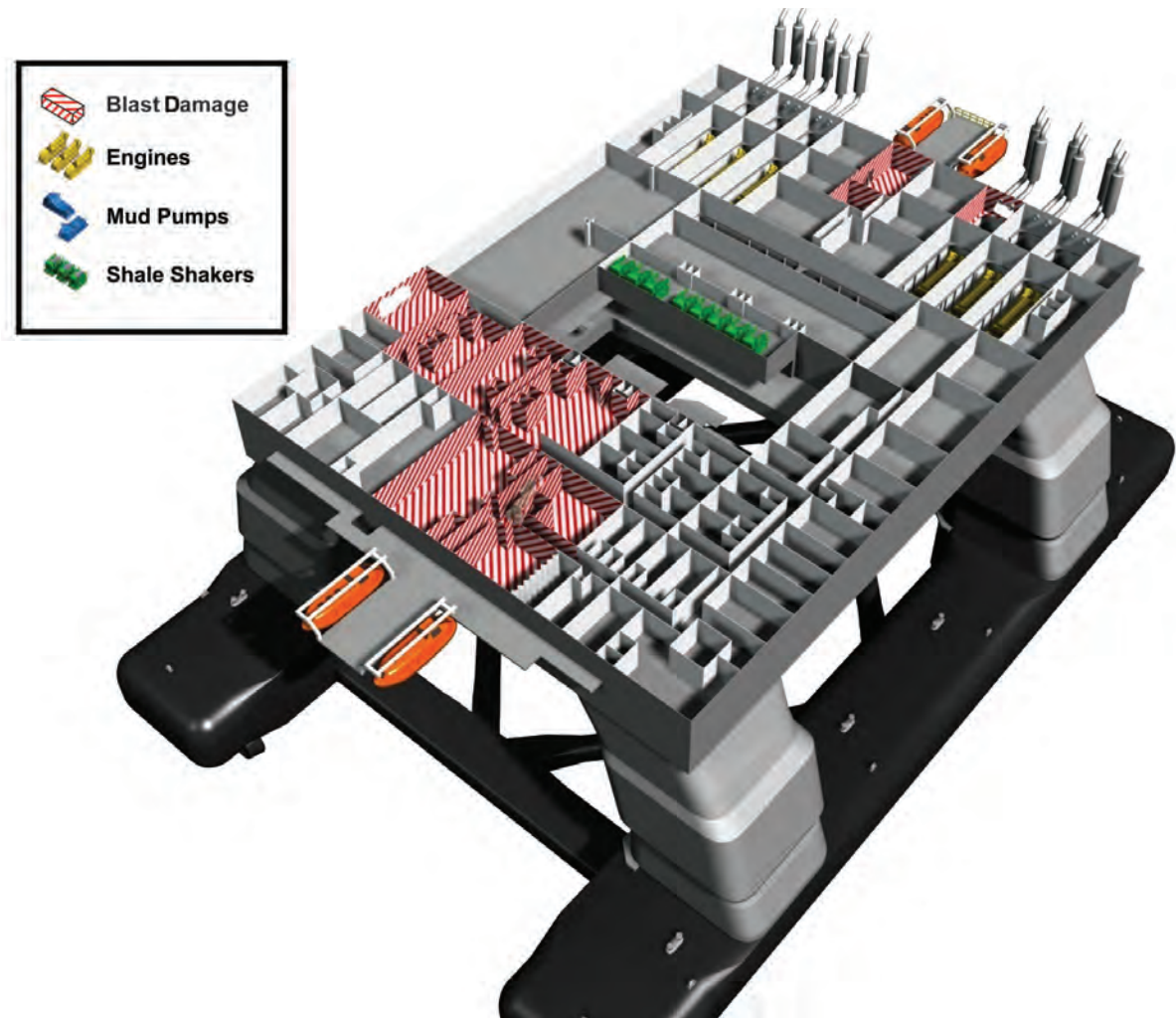

Figure 18 Blast Damage - Second Deck

3.5.6 Gas Dispersion and Ignition Findings of Fact

- The selection of the MGS may have appeared appropriate with the measured flow rates at 9:41 p.m. However, with the rapid expansion of gas in the riser, the MGS was quickly overwhelmed and hydrocarbons reached the aft deck, rig floor, and certain pump spaces.
- Ignition likely occurred in the aft engine rooms or deck area, and the blast traveled through the sack storage area room into the accommodations.
- The ambient environment contributed to the magnitude of the explosion by not dispersing gas away from the rig.
- It does not appear actions were taken to direct flow through the main overboard diverter lines prior to the explosion. It is impossible given the magnitude of the blowout to know if the diverter packer would have kept flow diverted overboard and if the gas ignition could have been prevented.
- The large volume of gas that reached the rig virtually assured ignition and subsequent explosion.
- The alarm and safety systems onboard the *Deepwater Horizon* functioned as designed and did not contribute to the ignition of reservoir fluid.
- The bridge team continuously monitored the fire and gas detection system and, in response to the incident, activated the alarm and distress systems on the rig.
- There were several sources that could have ignited the gas, but the investigation team found it impossible to confirm which was responsible.

1. See Chapter 3.1, Well Design; Testimony of Charles Credeur, Hearing before the *Deepwater Horizon* Joint Investigation Team, May 29, 2010, 62:19–63:2; Transocean Investigation Team Interview of Caleb Holloway, May 28, 2010; Transocean Investigation Team Interview of Allen Seraile, June 3, 2010.
2. The United States Coast Guard, Donald Vidrine Witness Statement, undated; Testimony of Miles Randy Ezell, Hearing before the *Deepwater Horizon* Joint Investigation Team, May 28, 2010, 282:25–283:13.
3. Stress Engineering Services Inc., Hydraulic Analysis of Macondo #252 Well Prior to Incident of April 20, 2010, April 27, 2011; Prospect, *Deepwater Horizon* Investigation Gas Dispersion Studies, March 31, 2011.
4. The United States Coast Guard, Paul Meinhart Witness Statement, April 21, 2010; The United States Coast Guard, Douglas Brown Witness Statement, April 21, 2010; Sperry Drilling Services data logs (drilling parameters), April 5–20, 2010.
5. Prospect, *Deepwater Horizon* Investigation Gas Dispersion Studies, March 31, 2011.
6. Testimony of Heber Morales, Hearing before the *Deepwater Horizon* Joint Investigation Team, May 29, 2010, 144:21–145:5; The United States Coast Guard, Carlos Ramos Witness Statement, April 21, 2010.
7. Prospect, *Deepwater Horizon* Investigation Gas Dispersion Studies, March 31, 2011.
8. Reading & Bates, RBS-8D Mud Gas Separator Drawing No. 9820139.
9. Testimony of Yancy Keplinger, Hearing before the *Deepwater Horizon* Joint Investigation Team, Oct. 5, 2010, 212:5–213:8; Transocean Investigation Team Interview of Caleb Holloway, May 28, 2010.
10. Testimony of Heber Morales, Hearing before the *Deepwater Horizon* Joint Investigation Team, May 29, 2010, 146:23–147:7; Testimony of Micah Sandell, Hearing before the *Deepwater Horizon* Joint Investigation Team, May 29, 2010, 10:5–22; 14:9–23.
11. ABB Vetco Gray, Telescopic Joint with Hydraulic Latch and Fluid Assist Bearing Operating and Service Procedure 6210, June 2000, 2; ABB Vetco Gray, Field Service Manual for Reading & Bates Drilling Co., RBS8D, *Deepwater Horizon*, HMF-H; Marine Riser System and Wellhead Connector, P.O. #MR-87-00023 Co's #C54927.
12. R&B Falcon RBS-8D *Deepwater Horizon*, Hydril S.O. 615911, P.O. 08700014, Operator's Manual, FS 21x60-500 Diverter Housing, FS 21x60-500 Diverter, FS 21x60-500 Handling Tool, 2000:27; Section 3.3.3, Table 3-2.
13. Testimony of Heber Morales, Hearing before the *Deepwater Horizon* Joint Investigation Team, May 29, 2010, 144:17–145:5.
14. *Deepwater Horizon* Marine Department Current Report, April 20, 2010, TRN-MDL-0029513, 132.
15. Operator Manual, Kongsberg Simrad SSS Fire and Gas System, *Deepwater Horizon*, March 2001.
16. Mobile Offshore Drilling Unit Safety Certificate, March 21, 2000, TRN-MDL-00272560; MMS Inspection Report, March 29, 2009.
17. Testimony of Andrea Fleytas, Hearing before the *Deepwater Horizon* Joint Investigation Team, Oct. 5, 2010, 13:7–14:6; The United States Coast Guard, Paul Meinhart Witness Statement, April 21, 2010.
18. Testimony of Yancy Keplinger, Hearing before the *Deepwater Horizon* Joint Investigation Team, Oct. 5, 2010, 152:7–12; The United States Coast Guard, Troy Hadaway Witness Statement, April 21, 2010.
19. R&B Falcon, Safety System Design Philosophy, Aug. 23, 2000, TRN-MDL-00402475; Kongsberg Simrad – Cable Layout RB58D, drawing No. 799622, pages 1–2 of 8.
20. *Deepwater Horizon* Fire Fighting & Lifesaving Plan – File #6087aUN1000-11.
21. Testimony of Andrea Fleytas, Hearing before the *Deepwater Horizon* Joint Investigation Team, Oct. 5, 2010, 8:23–9:4, 10:12–20; Testimony of Yancy Keplinger, Hearing before the *Deepwater Horizon* Joint Investigation Team, Oct. 5, 2010, 140:2–5. See Transocean Job Description (Marine Based) Dynamic Positioning Operator.
22. Transocean, *Deepwater Horizon* Emergency Response Manual, Section 4, March 31, 2006.
23. Testimony of Andrea Fleytas, Hearing before the *Deepwater Horizon* Joint Investigation Team, Oct. 5, 2010, 54:7–18; Testimony of Yancy Keplinger, Hearing before the *Deepwater Horizon* Joint Investigation Team, Oct. 5, 2010, 151:1–8, 152:7–16.

24. U.S. Department of Transportation, United States Coast Guard, Navigation and Vessel Inspection Circular No. 2-89 (remains in effect).
25. IMCA, Guidelines for the Design and Operation of Dynamically Positioned Vessels, 10–11.
26. R&B Falcon, Safety System Design Philosophy, RBS8D Project, Aug. 23, 2000.
27. Code for the Construction and Equipment of Mobile Offshore Drilling Units, Consolidated Edition, Section 6, 2001.
28. Prospect, *Deepwater Horizon* Investigation Gas Dispersion Studies, March 31, 2011.
29. *Deepwater Horizon* Operations Manual, Section 9.1, March 2001, HCEC-00018328.
30. *Deepwater Horizon* Operations Manual, Section 8.5, March 2001, HCEC-00018328.
31. R&B Falcon, Safety System Design Philosophy, Aug. 23, 2000, MDL-00402475.
32. Mobile Offshore Drilling Unit Safety Certificate, March 21, 2000, TRN-MDL-00272560; MMS Inspection Report, June 9, 2009.
33. R&B Falcon, Safety System Design Philosophy, Aug. 23, 2000, MDL-00402475.
34. Testimony of Andrea Fleytas, Hearing before the *Deepwater Horizon* Joint Investigation Team, Oct. 5, 2010, 13:10–20; Testimony of Yancy Keplinger, Hearing before the *Deepwater Horizon* Joint Investigation Team, Oct. 5, 2010, 150:22–151:3.
35. Testimony of William Stoner, Hearing before the *Deepwater Horizon* Joint Investigation Team, May 28, 2010, 341:8–19.
36. Prospect, *Deepwater Horizon* Investigation Gas Dispersion Studies, March 31, 2011.
37. R&B Falcon, Safety Systems Design Philosophy, Aug. 23, 2000, MDL-00402475.
38. Prospect, *Deepwater Horizon* Investigation Gas Dispersion Studies, March 31, 2011.
39. Testimony of Andrea Fleytas, Hearing before the *Deepwater Horizon* Joint Investigation Team, Oct. 5, 2010, 13:11–14; Testimony of Yancy Keplinger, Hearing before the *Deepwater Horizon* Joint Investigation Team, Oct. 5, 2010, 150:22–151:3.
40. R&B Falcon, Safety Systems Design Philosophy, Aug. 23, 2000, TRN-MDL-00402475.
41. *Ibid.*
42. HITEC FDS Driller's work station ST3784-FDS-100; R&B Falcon, Safety Systems Design Philosophy, Aug. 23, 2000, TRN-MDL-00402475.
43. Transocean Purchase Order ("Repair Purge Air in Toolpushers BOP Panel") (undated; printed February 14, 2011); Tag Description: Drillers BOP Control Panel, Job No. 1550038093281, Jan. 18, 2009.
44. Testimony of Mark Hay, Hearing before the *Deepwater Horizon* Joint Investigation Team, Aug. 25, 2010, 218:12–24.
45. Prospect, *Deepwater Horizon* Investigation Gas Dispersion Studies, March 31, 2011.
46. Testimony of William Stoner, Hearing before the *Deepwater Horizon* Joint Investigation Team, May 28, 2010, 340:16–341:21; The United States Coast Guard, Doug Brown Witness Statement, April 21, 2010.
47. Wartsila, NSD Installation Planning Instructions Doc. ID No. 4V69L1629, Version 5.6; Kongsberg Simrad Function Design Specification R&B Falcon RBS8D *Deepwater Horizon*, October 2000.
48. The United States Coast Guard, Carlos Ramos Witness Statement, April 21, 2010; Prospect, *Deepwater Horizon* Investigation Gas Dispersion Studies, March 31, 2011; The United States Coast Guard, Denis Martinez Witness Statement, April 21, 2010.
49. Transocean Investigation Team Interview of Caleb Holloway, May 28, 2010; Prospect, *Deepwater Horizon* Investigation Gas Dispersion Studies, March 31, 2011.
50. Prospect, *Deepwater Horizon* Investigation Gas Dispersion Studies, March 31, 2011.
51. Testimony of Stephen Bertone, Hearing before the *Deepwater Horizon* Joint Investigation Team, July 19, 2010, 41:5–14.

52. Testimony of Chad Murray, Hearing before the *Deepwater Horizon* Joint Investigation Team, May 27, 2010, 314:2–9.
53. Prospect, *Deepwater Horizon* Investigation Gas Dispersion Studies, March 31, 2011.
54. Testimony of Andrea Fleytas, Hearing before the *Deepwater Horizon* Joint Investigation Team, Oct. 5, 2010, 13:10–13; Testimony of Yancy Keplinger, Hearing before the *Deepwater Horizon* Joint Investigation Team, Oct. 5, 2010, 150:22–151:7; Prospect, *Deepwater Horizon* Investigation Gas Dispersion Studies, March 31, 2011.
55. Harold Wilson e-mail message to Billy Brown, Oct. 13, 2010, TDW-06611; Beaird Industries Inc. – MSA1 Maxim Spark Arrestor Silencer.
56. Transocean Investigation Team Interview of Kennedy Cola, June 17, 2010; Transocean Investigation Team Interview of Mike Mayfield, June 3, 2010.
57. Transocean Investigation Team Interview of Cole Jones, June 1, 2010; Huffington Post, May 9, 2010, marine biology student Albert Andry III and three friends had come to the *Deepwater Horizon* to fish.
58. Testimony of Chad Murray, Hearing before the *Deepwater Horizon* Joint Investigation Team, May 27, 2010, 328:2–17.
59. The United States Coast Guard, Troy Hadaway Witness Statement, April 21, 2010; Testimony of Chad Murray, Hearing before the *Deepwater Horizon* Joint Investigation Team, May 27, 2010, 315:15–24; The United States Coast Guard, Stan Carden Witness Statement, April 21, 2010; The United States Coast Guard, Mike Williams Witness Statement, April 21, 2010; The United States Coast Guard, Doug Brown Witness Statement, April 21, 2010; The United States Coast Guard, John Evans Witness Statement, April 21, 2010.
60. *Ibid.*

3.6 Muster and Evacuation

3.6.1 Emergency Alarms and Mustering

This event created extremely challenging conditions for all persons onboard. The explosions and fire happened in the evening, when many off-tour crew members were asleep or in their cabins. There was blast damage to various portions of the rig, and some muster points were not accessible. Some crew members were injured and could not evacuate without assistance. It appears that, under the stress of the emergency, a few persons onboard evacuated independently rather than per procedure and as trained. However, despite these obstacles and challenges, muster, evacuation plans, and training facilitated the evacuation of all 115 survivors to the *Damon B. Bankston* supply vessel nearby. In addition to the heroic actions of many of the crew, assistance from the crew of the *Bankston* was critical in the rescue effort. The 17 most seriously injured survivors were airlifted to hospitals for treatment.¹

The *Deepwater Horizon* emergency response plan required all personnel to assemble at their designated muster points immediately following the sounding of the general alarm and public address (PA) announcements.² The “fire and emergency” alarm was seven or more short blasts followed by one long blast on the rig’s general alarm and supplemented by the rig’s whistle for no fewer than 10 seconds.³ The “prepare to abandon” signal was a continuous ringing of the general alarm and supplemented by the rig’s whistle for no fewer than 10 seconds.⁴ In areas with high noise levels, such as the engine and mud pump rooms, alarms were also indicated by lights, and all alarms were supported by PA announcements.⁵

Muster points were displayed on the rig’s station bill, which was posted on doors, walls, and passageways, and all cabins throughout the rig.⁶ All personnel were instructed on the location of their muster points and designated lifeboats when they first arrived onboard the rig and underwent induction and orientation.⁷ To verify that personnel were familiar with their primary and secondary muster locations, mustering response was practiced onboard the *Deepwater Horizon* during weekly emergency response drills.⁸

Location of Personnel on April 20

There were 126 people onboard the *Deepwater Horizon* on the night of April 20, 2010, including the *Deepwater Horizon* crew, the BP well site team, third-party contractors, and visitors from both Transocean and BP shore-based management.⁹ At the time of the incident, on-duty crew members were in work areas, such as the main deck, the rig floor (including the driller’s work station), mud pump room, engine control room (ECR), warehouse, workshops, and the vessel’s bridge and offices within the accommodations (living quarters). Off-duty crew members were in areas such as the living quarters, where many were sleeping at the time of the incident.

Initial Emergency Response

At approximately 9:45 p.m., a member of the drill crew called the bridge to report a well-control situation and then hung up.¹⁰ The bridge team attempted to return the call to get more information but got no response.¹¹ Moments later, at about 9:47 p.m., the gas-detection system alarm panel on the bridge began to activate, first indicating the presence of gas in the shale shaker house, then the drill floor, and then other areas of the *Deepwater Horizon*.^{12, A} As trained, the bridge team immediately called the shale shaker house to alert personnel and gather information, but they got no response.¹³ Shortly thereafter, the bridge team received a call from the engine control room and informed the crew member of a well-control situation.¹⁴ The bridge team called the *Bankston* at about 9:48 p.m. and instructed her to move a safe distance away from the rig to a standby position.¹⁵

Senior rig personnel from both Transocean and BP were notified of the well-control event before the first alarms sounded and were attempting to respond to requests for assistance when the rig lost power and the first explosion occurred.¹⁶ Following the first explosion at about 9:49 p.m., the bridge team sounded the general alarm and made a PA announcement instructing personnel to muster in the galley and cinema.¹⁷ See Figure 1.

Survivors reported hearing both the alarms and the PA announcements in various areas of the rig, including the accommodations and on the deck. Although some do not remember hearing or seeing the alarms,¹⁸ it is likely

A There also were gas detection system alarm panels at other locations on the rig, and these also would have lit up but were not being actively monitored. The alarm panel on the bridge is monitored constantly.

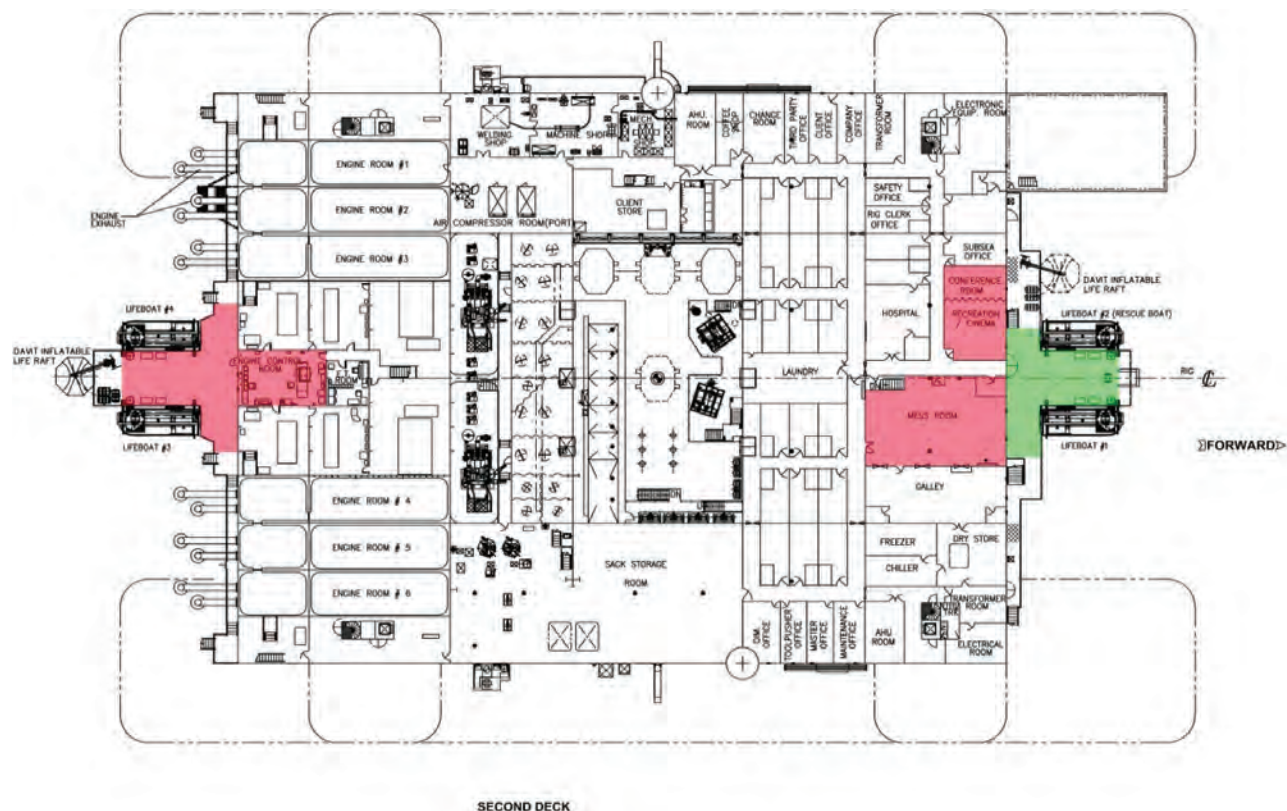

Figure 1 Muster Stations – Available Highlighted in Green; Impaired Highlighted in Red

that some of the alarm-signaling devices were damaged by the explosions and subsequent fire.

At the sounding of the general alarm, the emergency command group mustered on the bridge.¹⁹ Other *Deepwater Horizon* crew members with emergency response duties attempted to proceed to their muster stations, such as the ECR and fire-fighting stations.²⁰ When the bridge team became aware that the galley and cinema were no longer viable muster stations because of damage and debris in the areas, they made another PA announcement at about 9:51 p.m., instructing personnel to proceed to the forward lifeboat stations.²¹ See Figure 1.

The response to the emergency and muster of personnel on the *Deepwater Horizon* was conducted under extremely difficult conditions, including:

- Loss of the rig's main power system and associated primary lighting (although undamaged battery-powered emergency lights reportedly were still working)²²
- Drilling mud on the deck creating slippery surfaces²³
- Damage and debris blocking some escape routes²⁴
- Extremely loud noise, similar to a jet engine, coming from the well and blowing through the rotary table on the rig floor and through other openings²⁵
- Fires, extreme heat, and flying debris²⁶

Transmission of Distress Signals and Activation of the Emergency Disconnect System (EDS)

At 9:53 p.m., the bridge team sent two distress messages. They activated the Global Maritime Distress Safety System (GMDSS) and, at roughly the same time, sent the first of several MAYDAY messages using the VHF radio.²⁷ These distress messages were received and responded to by the U.S. Coast Guard (USCG) and

vessels in the area, including the *Bankston*.²⁸

At about 9:56 p.m., the offshore installation manager (OIM), one of the subsea engineers, and one of the BP well site leaders were on the bridge and attempted to activate the emergency disconnect system (EDS) on the blowout preventer (BOP) control panel to disconnect the rig and its marine riser from the BOP stack.²⁹ The power and lights on the BOP control panel were still on, indicating that it was functioning, but post-incident analyses confirm that the EDS did not successfully separate the rig from the BOP stack.³⁰ This is almost certainly due to the explosions and fire damaging or destroying BOP control cables.³¹ See *Chapter 3.4* for a complete discussion on the *Deepwater Horizon* BOP.

Attempt to Regain Power

When the chief engineer mustered on the bridge, he tried to determine why the main power supply had failed and the main engines had stopped.³² When the ECR team reached the bridge, they reported that the engine control and pump rooms had been extensively damaged.³³ The chief engineer and two colleagues then left the bridge and attempted to start the standby generator at about 9:59 p.m.,³⁴ but they were unable to restore power. During the incident, display screens such as the fire and gas detection system and the BOP control panel were still operating, indicating that the uninterruptible power supply on the bridge was functioning.³⁵

On-rig Search and Rescue for Missing/Injured Personnel

Search and rescue for injured personnel took place within the living quarters.³⁶ One injured person found in the galley/mess room area was escorted to the rig medic.³⁷ Three people were found in the starboard alleyway near the maintenance office on the second deck level.³⁸ Two of these people were seriously injured and had to be rescued on stretchers; a third person, though disoriented from the explosion, was able to assist with the recovery of the other two. Due to the intense heat from the fires and damage caused by the explosions, search and rescue operations were limited in other areas.

Mustering Prior to Abandonment

Personnel responded to the general alarm and the PA announcements and reported to muster stations.³⁹ As a result of the incident, some muster points such as the ECR were impaired.⁴⁰ Personnel assigned to those points went to alternatives — either the bridge or the forward lifeboat station. The forward lifeboat station was not impaired, and all of the survivors who made their way to this point evacuated the rig. See *Figure 1*.

Muster at Forward Lifeboats

Personnel without designated emergency response duties responded to the PA announcements and started to muster at the forward lifeboats at about 9:52 p.m.⁴¹ The first personnel arrived at this muster station before the designated muster checkers were in position, and some ad hoc mustering occurred at this early stage.⁴² The off-duty assistant drillers — the designated muster checkers — arrived and started to check off personnel names against their designated lifeboats, Nos. 1 or 2.⁴³ The muster checkers made several attempts to verify and check off the muster before personnel left the rig, but a full muster was not completed until all of the survivors were safely onboard the *Bankston*.⁴⁴

Decision to Abandon

From the information the bridge team received, it quickly became apparent that it would be impossible to regain control of the well or to fight the fires, and the captain gave word to abandon.⁴⁵ Before leaving the bridge at about 10:28 p.m., the bridge team made a PA announcement that they were abandoning the rig and sent a final distress message. They then went to the forward lifeboat muster station and evacuated the rig.⁴⁶

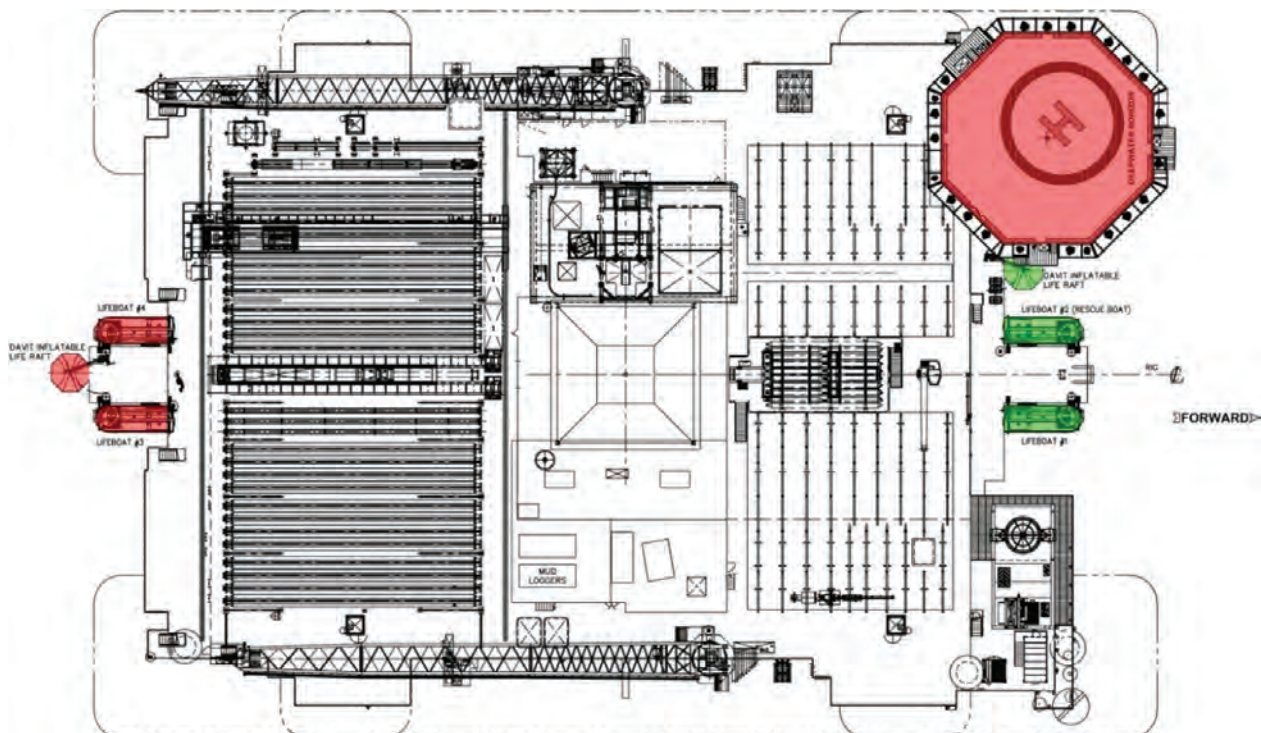

Figure 2 Evacuation Points – Lifeboats and Life Raft Used in Evacuation Highlighted in Green; Impaired Evacuation Systems Highlighted in Red.

3.6.2 Evacuation and Escape

As noted above, the *Deepwater Horizon* evacuation and escape systems worked as designed. One hundred people evacuated in the forward lifeboats, seven evacuated in one of the forward life rafts, and eight jumped from the forward end of the rig into the sea. After the survivors reached the *Bankston*, the 17 most seriously injured survivors were airlifted by USCG helicopters to hospitals for treatment.⁴⁷

Regulatory Compliance

The evacuation and escape systems on the *Deepwater Horizon* were designed and maintained in compliance with the International Standards of Safety of Life at Sea (SOLAS 1974 regulations) and USCG requirements under the Code of Federal Regulations (C.F.R.) for foreign flag vessels operating on the U.S. outer continental shelf.⁴⁸ In addition, the systems were inspected independently by the American Bureau of Shipping (ABS) for the rig's mobile offshore drilling unit (MODU) safety certificate, valid through Feb. 28, 2011, and as a part of the *Report of Safety Inspection for MODU/MOU* for the Marshall Islands, the rig's flag state.⁴⁹ They also were inspected by the USCG, most recently on July 27, 2009, when the inspectors noted the *Deepwater Horizon's* "outstanding safety culture, performance during drills and condition of the rig. No deficiencies issued, none are outstanding."⁵⁰

Evacuation Methods

1. **Lifeboats:** The *Deepwater Horizon* had four lifeboats — two located at the forward end of the rig adjacent to the living quarters and two at the aft on the second deck level. See *Figure 2*. Each lifeboat was designed and certified to carry 73 people so that even if the rig had been at its full capacity of 146 (instead of the 126 onboard that day), every person could have been evacuated using only the two accessible lifeboats.⁵¹
2. **Life Rafts:** The *Deepwater Horizon* was equipped with six self-inflating life rafts. The life rafts were located next to the lifeboats, three forward and three aft, on the second deck level. See *Figure 2*. The

life rafts had a maximum capacity of 25 people each and were davit launched (a suspension system that lowers the rafts to the sea).⁵²

Evacuation Sequence

Based on witness testimony, personnel evacuated or escaped from the forward end of the *Deepwater Horizon* in the following order:

- 4 people jumped before the lifeboats were launched.
- 100 people evacuated on lifeboats Nos. 2 and 1.
- 7 people evacuated on a lift raft.
- 4 people jumped after the life raft was launched.

Evacuation by Lifeboat

One hundred^B of the 115 survivors evacuated the *Deepwater Horizon* on the forward lifeboats — No. 2, which launched first, followed by No. 1. Access to the aft lifeboats was blocked by damage from the explosions.⁵³ See *Figure 2*. Not all evacuated in their designated lifeboats,⁵⁴ and it has not been possible to establish how many people were in each lifeboat. The OIM checked the condition of its davits of lifeboat No. 1, and one injured person on a stretcher was loaded into this boat.⁵⁵

Lifeboat No. 2 was launched first at about 10:19 p.m.⁵⁶ Witnesses did not report any significant issues during the launch from the rig. Once in the water, the coxswain operated the lifeboat fall release.⁵⁷ There was a small problem releasing the aft fall, but this was remedied by opening the aft hatch and assisting the release by hand.⁵⁸ Once the lifeboat was approximately 1,000 ft. from the rig, the coxswain handed the operation over to a more senior staff member, who then maneuvered the boat alongside the *Bankston*.⁵⁹

Lifeboat No. 1 was launched at about 10:25 p.m.⁶⁰ Witnesses did not report any significant issues during the actual launch process from the rig (i.e., the brakes released as expected and the lifeboat descended to the water without any problems). Once in the water, the coxswain operated the fall release without any problems and used a portable VHF radio to contact the *Bankston*.⁶¹ Once in the water, a senior member of Transocean staff exited the boat to assist with navigation to the *Bankston* because the boat's windows were obscured by mud that had blown out from the well.⁶²

Evacuation by Life Raft

After the two lifeboats left the *Deepwater Horizon*, 11 survivors remained onboard. Because the aft lifeboats were not available, one of the forward davit-launched life rafts was prepared.⁶³ After the raft was inflated, a problem with the launching arrangements caused a brief delay,⁶⁴ and then one person boarded and assisted loading a person on a stretcher, followed by five others.⁶⁵

The life raft was lowered with seven people onboard at about 10:35 p.m.⁶⁶ When the raft was approximately halfway down, it turned almost vertical, and all of its occupants were thrown to one side. What caused this is unknown, but the occupants managed to right the raft and continued the descent to the water.⁶⁷

Once the life raft reached the sea, four of the occupants entered the water. One person was picked up by the *Bankston* fast rescue craft (FRC).⁶⁸ The other three entered the water intending to move the raft away from the rig⁶⁹ but discovered it was still attached by the painter line to the rig's deck.⁷⁰ The knife stored on the raft could not be found and efforts to detach the line by hand were unsuccessful.⁷¹ The FRC coxswain maneuvered into position so that a knife could be passed to one of the people in the water, who cut the line.⁷² The FRC crew then towed the life raft away from the *Deepwater Horizon* to the *Bankston*. (The knife was discovered in its designated location on the raft before the *Bankston* left the Macondo location.)⁷³

^B One hundred (100) is calculated by deducting those missing (11), those who evacuated by life raft (7), and those who jumped (8) from the total number of persons on board (126).

Alternative Escape Methods

Eight people jumped into the sea from the *Deepwater Horizon*. Four entered the sea before the lifeboats and life raft were launched, between about 9:59 p.m. and 10:09 p.m., and were picked up by the FRC and taken to the *Bankston*, where they were triaged.⁷⁴ One of the four was physically injured when he jumped.⁷⁵

Four other survivors remained on the rig after the lifeboats and life raft were launched.⁷⁶ They later said that because they could not access the aft lifeboats, they considered launching a second life raft or climbing down a ladder, but the fire was becoming so intense they decided to jump from the bow at approximately 10:37 p.m.⁷⁷ After the four entered the water, they were able to reach the life raft, where they clung to its side or were picked up by the FRC. They were then taken to the *Bankston* and triaged.

Role of the *Damon B. Bankston*

All 115 survivors from the *Deepwater Horizon* were recovered by the *Bankston*.⁷⁸ At the time of the incident, the *Bankston* was on station approximately 40 ft. off the port side of the *Deepwater Horizon*.⁷⁹

The *Bankston* crew first noticed that something was wrong on the *Deepwater Horizon* at about 9:44 p.m., when mud began to rain down onto the vessel from the rig.⁸⁰ The *Bankston* then received a call from the bridge team onboard the *Deepwater Horizon* at about 9:48 p.m. to report the well-control incident and instruct the *Bankston* to move away from the rig to a standby position.⁸¹

In response to distress messages from the *Deepwater Horizon*, and after observing the lifeboat launch preparations and people jumping into the water, the captain of the *Bankston* launched his FRC at about 10:12 p.m.⁸² Although the weather conditions were good, the captain of the *Bankston* maneuvered his vessel so that the lifeboats and life raft could tie up securely alongside the starboard side of the *Bankston* and disembark.⁸³ Lifeboat No. 2 was unloaded first at about 10:34 p.m., followed by lifeboat No. 1 at about 10:39 p.m. and the life raft at about 10:53 p.m.⁸⁴ Once all of the survivors were onboard the *Bankston* and the triage of the injured had begun, a muster was organized to determine how many people had evacuated the *Deepwater Horizon* and who was still missing; this was completed at about 11:30 p.m.⁸⁵

The *Bankston* had limited medical assistance capabilities and was not equipped to support the 115 survivors, but the captain and crew of the *Bankston* provided all possible aid, and another vessel provided additional medical supplies.⁸⁶ The first USCG helicopters arrived at approximately 11:25 p.m. and passed down a number of rescue swimmers and a flight surgeon. After assessment, the 17 most seriously injured were airlifted to hospitals starting at approximately 12:06 a.m., April 21, 2010.⁸⁷ The USCG and a number of vessels responded to the *Deepwater Horizon* distress calls and conducted extensive searches for the missing until approximately 7 p.m. on April 23, 2010.⁸⁸

3.6.3 Muster and Evacuation Findings of Fact

- All personnel who survived the explosions made their own way or were assisted by co-workers to the forward lifeboat muster station and successfully evacuated the rig.
- The fires were determined to be too intense to fight, and they limited search and rescue operations.
- With the exception of a few minor issues, both forward lifeboats launched as expected and were able to power their own way to the *Bankston*.
- The *Bankston* crew and fast rescue craft (FRC) were critical in assisting in the safe recovery of personnel in the sea and in moving the life raft away from the rig.
- The benign weather conditions contributed to the survival of those who jumped from the rig.
- The marine crew took appropriate actions to signal for help and ensure survivors evacuated the rig.
- Battery-powered uninterrupted power supplies and emergency lighting functioned as designed.

1. Transocean Park Ten Emergency Response Center Log, April 20, 2010, TRN-MDL-00038789.
2. Transocean *Deepwater Horizon* Station Bill, June 18, 2009, MDL-00522627.
3. *Ibid.*
4. *Ibid.*
5. R&B Falcon, Safety System Design Philosophy, Aug. 23, 2000, MDL-00402475.
6. Transocean *Deepwater Horizon* Station Bill, June 18, 2009, MDL-00522627.
7. Transocean Health & Safety Policies and Procedures Manual, Section 4.1.1, Dec. 15, 2009, TRN-MDL-00046464,583.
8. Transocean Weekly Drill Report *Deepwater Horizon*, April 12–18, 2010, TRN-TBD-00001335; Testimony of Gregory Meche, Hearing before the *Deepwater Horizon* Joint Investigation Team, May 28, 2010, 221:15–24.
9. Transocean Personnel On-Board, *Deepwater Horizon*, April 20, 2010, TRN-MDL-00030428.
10. Testimony of Andrea Fleytas, Hearing before the *Deepwater Horizon* Joint Investigation Team, Oct. 5, 2010, 13:20–23; 39:8–16; Testimony of Yancy Keplinger, Hearing before the *Deepwater Horizon* Joint Investigation Team, Oct. 5, 2010, 150:14–16.
11. Transocean Investigation Team Interview of Andrea Fleytas, June 24, 2010.
12. Testimony of Andrea Fleytas, Hearing before the *Deepwater Horizon* Joint Investigation Team, Oct. 5, 2010, 13:13–14; Testimony of Yancy Keplinger, Hearing before the *Deepwater Horizon* Joint Investigation Team, Oct. 5, 2010, 150:22–151:3; Testimony of Paul Meinhart, Hearing before the *Deepwater Horizon* Joint Investigation Team, May 29, 2010, 29:5–7.
13. Testimony of Yancy Keplinger, Hearing before the *Deepwater Horizon* Joint Investigation Team, Oct. 5, 2010, 151:1–9.
14. Testimony of Andrea Fleytas, Hearing before the *Deepwater Horizon* Joint Investigation Team, Oct. 5, 2010, 13:23–14:1, 39:17–22.
15. Testimony of Paul Meinhart, Hearing before the *Deepwater Horizon* Joint Investigation Team, May 29, 2010, 29:5–11, 29:1; Weekly Leader Episode 68 Podcast of Captain Alwin Landry Interview, Oct. 5, 2010.
16. Testimony of Miles Ezell, Hearing before the *Deepwater Horizon* Joint Investigation Team, May 28, 2010, 282:25–283:24; The United States Coast Guard, Donald Vidrine Witness Statement, undated.
17. Testimony of Yancy Keplinger, Hearing before the *Deepwater Horizon* Joint Investigation Team, Oct. 5, 2010, 152:7–10; Transocean Investigation Team Interview of Mike Mayfield, June 3, 2010; Testimony of Greg Meche, Hearing before the *Deepwater Horizon* Joint Investigation Team, May 28, 2010, 232:10–16; Transocean Investigation Team Interview of Troy Hadaway, May 21, 2010.
18. Testimony of Micah Burgess, Hearing before the *Deepwater Horizon* Joint Investigation Team, May 29, 2010, 85:24–87:6; Testimony of Gregory Meche, Hearing before the *Deepwater Horizon* Joint Investigation Team, May 28, 2010, 232:10–235:17; Transocean Investigation Team Interview of Kennedy Cola, June 17, 2010.
19. Testimony of Steve Bertone, Hearing before the *Deepwater Horizon* Joint Investigation Team, July 19, 2010, 36:1–4 ;The United States Coast Guard, Jimmy Wayne Harrell Witness Statement, April 21, 2010; Transocean Station Bill, June 18, 2009, TRN-MDL-00522627.
20. Testimony of Heber Morales, Hearing before the *Deepwater Horizon* Joint Investigation Team, May 29, 2010, 145:17–146:13; Testimony of David Young, Hearing before the *Deepwater Horizon* Joint Investigation Team, May 27, 2010, 264:17–266:2.
21. Testimony of Micah Burgess, Hearing before the *Deepwater Horizon* Joint Investigation Team, May 29, 2010, 84:2–8; Testimony of Andrea Fleytas, Hearing before the *Deepwater Horizon* Joint Investigation Team, Oct. 5, 2010, 14:9–11.
22. Transocean Investigation Team Interview of Eric Estrada, June 24, 2010; Transocean Investigation Team Interview of Thomas Cole, June 2, 2010.
23. Testimony of Jimmy Harrell, Hearing before the *Deepwater Horizon* Joint Investigation Team, May 27, 2010, 66:5–14; The United States Coast Guard, Truitt Crawford Witness Statement, April 21, 2010.
24. Transocean Investigation Team Interview of Troy Hadaway, May 21, 2010; Transocean Investigation Team Interview of Thomas Cole, June 2, 2010.
25. Transocean Investigation Team Interview of Caleb Holloway, May 28, 2010.

26. Testimony of Jimmy Harrell, Hearing before the *Deepwater Horizon* Joint Investigation Team, May 27, 2010, 65:22–66:6; The United States Coast Guard, Heber Morales Witness Statement, April 21, 2010, TRN-HCJ-00120958; The United States Coast Guard, Carlos Ramos Witness Statement, April 21, 2010; The United States Coast Guard, Joseph Keith, April 22, 2010, TRN-HCJ-00120974.
27. Testimony of Andrea Fleytas, Hearing before the *Deepwater Horizon* Joint Investigation Team, Oct. 5, 2010, 14:17–19; The United States Coast Guard, Yancy Keplinger, Witness Statement, April 21, 2010, TRN-HCJ-00121037.
28. Testimony of Paul Erickson, Hearing before the *Deepwater Horizon* Joint Investigation Team, May 11, 2010, 235:10–15; Testimony of Captain Alwin Landry, Hearing before the *Deepwater Horizon* Joint Investigation Team, May 11, 2010, 105:3–10.
29. Testimony of Curt Kutcha, Hearing before the *Deepwater Horizon* Joint Investigation Team, May 27, 2010, 189:25–190:14; Testimony of Chris Pleasant, Hearing before the *Deepwater Horizon* Joint Investigation Team, May 28, 2010, 123:1–13; Testimony of Jimmy Harrell, Hearing before the *Deepwater Horizon* Joint Investigation Team, May 27, 2010, 10:17–11:13.
30. Testimony of Jimmy Harrell, Hearing before the *Deepwater Horizon* Joint Investigation Team, May 27, 2010, 69:4–71:24; Testimony of Chris Pleasant, Hearing before the *Deepwater Horizon* Joint Investigation Team, May 28, 2010, 155:1–18.
31. Testimony of Steve Bertone, Hearing before the *Deepwater Horizon* Joint Investigation Team, July 19, 2010, 41:6–14.
32. Testimony of Steve Bertone, Hearing before the *Deepwater Horizon* Joint Investigation Team, July 19, 2010, 36:1–37:8.
33. Testimony of Stephen Bertone, Hearing before the *Deepwater Horizon* Joint Investigation Team, July 19, 2010, 37:9–19; Testimony of Mike Williams, Hearing before the *Deepwater Horizon* Joint Investigation Team, July 23, 2010, 18:9–16.
34. Testimony of Stephen Bertone, Hearing before the *Deepwater Horizon* Joint Investigation Team, July 19, 2010, 39:23–43:7; Testimony of Yancy Keplinger, Hearing before the *Deepwater Horizon* Joint Investigation Team, Oct. 5, 2010, 152:23–153:4.
35. Testimony of Andrea Fleytas, Hearing before the *Deepwater Horizon* Joint Investigation Team, Oct. 5, 2010, 55:6–14; Testimony of Chris Pleasant, Hearing before the *Deepwater Horizon* Joint Investigation Team, May 28, 2010, 153:21–155:15.
36. The United States Coast Guard, Stan Carden Witness Statement, April 21, 2010, TRN-HCJ-00121053; The United States Coast Guard, Chad Murray Witness Statement, April 21, 2010.
37. Statement of Robert Hearn taken by Norman Anseman, April 22, 2010; The United States Coast Guard, Chad Murray Witness Statement, April 21, 2010.
38. The United States Coast Guard, Chad Murray Witness Statement, April 21, 2010.
39. Testimony of Gregory Meche, Hearing before the *Deepwater Horizon* Joint Investigation Team, May 28, 2010, 233:4–234:13; Transocean Investigation Team Interview of Thomas Cole, June 2, 2010; The United States Coast Guard, Michael Glen Denning Witness Statement, April 21, 2010.
40. Testimony of Micah Burgess, Hearing before the *Deepwater Horizon* Joint Investigation Team, May 29, 2010, 84:2–8; Testimony of William Stoner, Hearing before the *Deepwater Horizon* Joint Investigation Team, May 28, 2010, 341–342:12.
41. The United States Coast Guard, John Quidobeaux, Jr. Witness Statement, April 21, 2010; The United States Coast Guard, John Lance Witness Statement, April 21, 2010; The United States Coast Guard, Carl Lavergne Witness Statement, April 21, 2010.
42. Transocean Investigation Team Interview of Caleb Holloway, May 28, 2010; Transocean Investigation Team Interview of Thomas Cole, June 2, 2010.
43. The United States Coast Guard, Patrick Morgan Witness Statement, April 21, 2010, TRN-HCJ-00121010; The United States Coast Guard, Allen Seraille Witness Statement, April 21, 2010; Lifeboat/Life Raft Crew Report (Lifeboat No. 1 – Forward), April 20, 2010, TRN-HCJ-00127832; Lifeboat/Life Raft Crew Report (Lifeboat No. 2 – Forward) April 20, 2010, TRN-HCJ-00127830.
44. *Damon Bankston* Log, April 20, 2010, TDW-0020.
45. Testimony of Curt Kuchta, Hearing before the *Deepwater Horizon* Joint Investigation Team, May 27, 2010, 191:23–192:4; Testimony of Andrea Fleytas, Hearing before the *Deepwater Horizon* Joint Investigation Team, Oct. 5, 2010, 21:16–19. Testimony of Yancy Keplinger, Hearing before the *Deepwater Horizon* Joint Investigation Team, Oct. 5, 2010 153:14–20, 171:16–18.
46. Testimony of Andrea Fleytas, Hearing before the *Deepwater Horizon* Joint Investigation Team, Oct. 5, 2010, 14:21–15:3; Testimony of Yancy Keplinger, Hearing before the *Deepwater Horizon* Joint Investigation Team, Oct. 5, 2010, 153:14–20, 260:19–261:16.
47. Transocean Park Ten Emergency Response Center Log, April 20, 2010, TRN-MDL-00038789.

48. 46 C.F.R. §109; Mobile Offshore Drilling Unit Safety Certificate, March 21, 2000, TRN-MDL-00272560.
49. ABS Survey Manager, Survey Status Report (for Owner), *Deepwater Horizon*, TRN-MDL-00272455; Mobile Offshore Drilling Unit Safety Certificate, March 21, 2000, TRN-MDL-00272560; The Republic of The Marshall Islands, Office of the Maritime Administrator, Report of Safety Inspection for MODU/MOU, Dec. 17, 2009, TRN-MDL-00268111.
50. MMS/USCG Rig Inspection Report, *Deepwater Horizon*, July 27, 2009.
51. Mobile Offshore Drilling Unit Safety Certificate, March 21, 2000, TRN-MDL-00272560; Transocean Personnel On-Board, *Deepwater Horizon* as of April 20, 2010, TRN-MDL-00030428.
52. Mobile Offshore Drilling Unit Safety Certificate, March 21, 2000, TRN-MDL-00272560.
53. Transocean Investigation Team Interview of Cole Jones, June 1, 2010.
54. Transocean Investigation Team Interview of Eric Estrada, June 24, 2010; Transocean Investigation Team Interview of Thomas Cole, June 2, 2010.
55. Testimony of Jimmy Harrell, Hearing before the *Deepwater Horizon* Joint Investigation Team, May 27, 2010, 48:14–49:5; Statement of Buddy Trahan, April 26, 2010, TRN-MDL-00120230; Transocean Investigation Team Interview of Thomas Cole, June 2, 2010.
56. The United States Coast Guard, Mike Mayfield Witness Statement, April 21, 2010.
57. The United States Coast Guard, Stephen Richards Witness Statement, April 21, 2010.
58. The United States Coast Guard, Will Jernigan Witness Statement, April 21, 2010.
59. Transocean Investigation Team Interview of Mike Mayfield, June 3, 2010.
60. Testimony of Daun Winslow, Hearing before the *Deepwater Horizon* Joint Investigation Team, Aug. 24, 2010, 15:1–7.
61. The United States Coast Guard, Darin Rupinski Witness Statement, April 21, 2010.
62. Testimony of Daun Winslow, Hearing before the *Deepwater Horizon* Joint Investigation Team, Aug. 23, 2010, 453:20–45:21.
63. Testimony of Chad Murray, Hearing before the *Deepwater Horizon* Joint Investigation Team, May 27, 2010, 331:2; Testimony of David Young, Hearing before the *Deepwater Horizon* Joint Investigation Team, May 27, 2010, 267–268; Testimony of Steve Bertone, Hearing before the *Deepwater Horizon* Joint Investigation Team, July 19, 2010, 44:8–15.
64. Testimony of Steve Bertone, Hearing before the *Deepwater Horizon* Joint Investigation Team, July 19, 2010, 44; Testimony of Mike Williams, Hearing before the *Deepwater Horizon* Joint Investigation Team, July 23, 2010, 22:15–16:21–25.
65. Testimony of Chad Murray, Hearing before the *Deepwater Horizon* Joint Investigation Team, May 27, 2010, 333:2–10; Testimony of David Young, Hearing before the *Deepwater Horizon* Joint Investigation Team, May 27, 2010, 268:16–22.
66. Testimony of Chad Murray, Hearing before the *Deepwater Horizon* Joint Investigation Team, May 27, 2010, 333:2–4.
67. Testimony of David Young, Hearing before the *Deepwater Horizon* Joint Investigation Team, May 27, 2010, 269:11–19; Testimony of Chad Murray, Hearing before the *Deepwater Horizon* Joint Investigation Team, May 27, 2010, 333:24–334:3.
68. Transocean Investigation Team Interview of Andrea Fleytas, June 24, 2010; Testimony of Anthony Gervasio, Hearing before the *Deepwater Horizon* Joint Investigation Team, May 11, 2010, 192:9–14.
69. Testimony of Chad Murray, Hearing before the *Deepwater Horizon* Joint Investigation Team, May 27, 2010, 334:9–15; Testimony of Steve Bertone, Hearing before the *Deepwater Horizon* Joint Investigation Team, July 19, 2010, 47:1–9.
70. Testimony of David Young, Hearing before the *Deepwater Horizon* Joint Investigation Team, May 27, 2010, 269:23–270:4; Testimony of Steve Bertone, Hearing before the *Deepwater Horizon* Joint Investigation Team, July 19, 2010, 48:6–11.
71. Testimony of David Young, Hearing before the *Deepwater Horizon* Joint Investigation Team, May 27, 2010, 269:20–270:4.
72. Testimony of Curt Kuchta, Hearing before the *Deepwater Horizon* Joint Investigation Team, May 27, 2010, 194:2–11; *Damon Bankston* Log, April 20, 2010, TDW-0020.
73. Testimony of Anthony Gervasio, Hearing before the *Deepwater Horizon* Joint Investigation Team, May 11, 2010, 192:17–193:11; Testimony of David Young, Hearing before the *Deepwater Horizon* Joint Investigation Team, May 27, 2010, 270:14–15, 270:20–271:6.

74. The United States Coast Guard, Brandon Boullion Witness Statement, April 21, 2010; The United States Coast Guard, Gregory Meche Witness Statement, April 21, 2010; The United States Coast Guard, Shane Faulk Witness Statement, April 21, 2010; Transocean Investigation Team Interview of Matthew Hughes, June 29, 2010.
75. Transocean Investigation Team Interview of Matthew Hughes, June 29, 2010.
76. The United States Coast Guard, Curt Kuchta Witness Statement, April 21, 2010; The United States Coast Guard, Michael Williams Witness Statement, April 21, 2010, TRN-HCJ-00120997,1001; The United States Coast Guard, Yancy Keplinger Witness Statement, April 21, 2010, TRN-HCJ-00121037; The United States Coast Guard, Paul Meinhart Witness Statement, April 21, 2010.
77. *Ibid.*
78. *Damon Bankston* Log, April 20, 2010, TDW-0020.
79. Weekly Leader Episode 68 Podcast of Captain Alwin Landry Interview, Oct. 5, 2010.
80. Testimony of Paul Erickson, Hearing before the *Deepwater Horizon* Joint Investigation Team, May 11, 2010, 231:10–24; Weekly Leader Episode 68 Podcast of Captain Alwin Landry Interview, Oct. 5, 2010.
81. Testimony of Paul Meinhart, Hearing before the *Deepwater Horizon* Joint Investigation Team, May 29, 2010, 29:6–11; Weekly Leader Episode 68 Podcast of Captain Alwin Landry Interview, Oct. 5, 2010.
82. *Damon Bankston* Log, April 20, 2010, TDW-0020.
83. *Damon Bankston* Log, April 20, 2010; Weekly Leader Episode 68 Podcast of Captain Alwin Landry Interview, Oct. 5, 2010.
84. Transocean Investigation Team Interview of Troy Hadaway, May 21, 2010; Testimony of Anthony Gervasio, Hearing before the *Deepwater Horizon* Joint Investigation Team, May 11, 2010, 193:9–11.
85. Transocean Investigation Team Interview of Jason Cooley, June 24, 2010; Transocean Investigation Team Interview of Andrea Fleytas, June 24, 2010. Lifeboat/Life Raft Crew Report (Lifeboat No. 1 – Forward), April 20, 2010, TRN-HCJ-00127832; Lifeboat/Life Raft Crew Report (Lifeboat No. 2 – Forward), April 20, 2010, TRN-HCJ-00127830.
86. Transocean Investigation Team Interview of Troy Hadaway, May 21, 2010; *Damon Bankston* Log, April 20, 2010, TDW-0020; Testimony of Captain Alwin Landry, Hearing before the *Deepwater Horizon* Joint Investigation Team, May 11, 2010, 113:14–114:4.
87. Transocean Park Ten Emergency Response Center Log, April 20, 2010, TRN-MDL-00038789; *Damon Bankston* Log, TDW-0020.
88. Testimony of Kevin Robb, Hearing before the *Deepwater Horizon* Joint Investigation Team, May 11, 2010, 60:22–61:6; *Damon Bankston* Log, April 20, 2010, TDW-0020.

4 Key Findings

This summarizes the key findings of the investigation team based on its extensive review of available information concerning the Macondo well incident.

As operator of the Macondo well, BP directed all aspects of its development. It chose the drilling location, designed the drilling program that included all operational procedures, set the target well depth, and created the temporary abandonment procedure for securing the well before departure of the drilling rig.

As drilling depths increased at Macondo, the window for safe drilling between the fracture gradient and the pore-pressure gradient became increasingly narrow. Maintaining the appropriate equivalent circulating density (ECD) became difficult, and BP experienced several kicks and losses of fluid to the formation. BP's knowledge of the narrowing window for safe operations guided key decisions during the final stage of operations. BP's changes from the original well plan in the final phase included:

- Reducing the target depth of the well
- Considering changes to the well casing
- Using a lower circulating rate than the parameters specified to convert the float collar
- Reducing cement density with nitrogen foam
- Using a lesser quantity of cement than that specified in BP procedures
- Deciding not to perform a complete bottoms-up circulation before cementing

Although aimed at protecting the formation and allowing operations to continue toward completion of the well, these decisions set the stage for the well control incident.

4.1 Running Production Casing

BP chose a long-string production casing design that required the development of a minimal and technically complex cement program to avoid damaging the formation during cementing, leaving little margin for error within normal field accuracy. BP and Halliburton then increased the risk by failing to adequately test the cement program.

The investigation confirmed that the operator's long-string casing design met the loading conditions that were experienced prior to and during the well-control incident. The use of this design, however, drove other plan departures that ultimately increased risk and contributed to the incident. Primarily, cementing the casing required a complex, small-volume, foamed cement program to prevent over-pressuring the formation. The plan allowed little room for normal field margin of error; it required exact calculation of annular volume and precise execution in order to produce an effective barrier to the reservoirs.

The operator had other abandonment alternatives. BP could have either installed a liner and tie-back or deferred the casing installation until the future completion operations began. Either approach would have placed additional and/or different barriers in the well prior to the negative pressure test and displacement.^A Deferring installation until future completion operations would have allowed additional time for detailed planning and verification of the design.

4.2 Converting the Float Collar

BP deviated significantly from its plan to convert the float collar, but proceeded despite observations of anomalies. The investigation team found it possible that the float collar did not convert and thus left a clear path for hydrocarbons to flow from the formations to the rig.

BP's planned procedure to convert the float collar called for slowly increasing fluid circulation rates to 5–8 barrels per minute (bpm) and to generate pressure of 500–700 psi at the float, consistent with the float manufacturer's guidelines. However, because of the increasingly narrow window to avoid fracturing the formation, BP deviated from its planned conversion procedure.

^A 30CFR250.1714–21.

BP made nine attempts to convert the float collar over the course of two hours. BP never circulated at a rate of more than 2 bpm, but it did increase the pressure applied on each successive attempt, finally achieving circulation at a pressure of 3,142 psi — almost five times that planned — and a flow rate of 1 bpm, less than ¼ of that planned. BP took this result as an indication that the float collar had converted even though the resulting circulating pressure was lower than BP’s model had predicted. The BP well site leader expressed concern about the issue, took steps to investigate it, and discussed the question of whether the float collar had converted with the Halliburton cementing engineer and BP’s shore team. Halliburton and BP proceeded, apparently having concluded that the float collar had converted.

The investigation team found it likely that debris in the wellbore may have plugged the shoe-track assembly and float collar and blocked circulation during the first eight attempts to convert the float collar. The increase to 3,142 psi may have cleared debris from the system without converting the float collar. If the float collar failed to convert, the cement program may have been further compromised.

4.3 Cementing

The precipitating cause of the Macondo incident was the failure of the cement in the shoe track and across the producing formations. This failed barrier allowed hydrocarbons to flow into the well.

The cement failed as a result of a number of factors that stemmed from BP’s ECD-driven management decisions between April 12 and 20, 2010. These factors include the complexity of the cement program; inadequate testing of the cement; likely cement contamination during the operation; and inadequate testing of the cement after it had been pumped.

Complexity of Cement Job

BP required a cement program that would exert minimal pressure on the formations. To minimize pressure, Halliburton devised a plan that called for pumping a small volume of cement, much of it nitrified, at a low rate. While this plan would help BP avoid losing cement into the formations, it required precise execution, left little room for error, and increased the risk of cement contamination.

Cement Program Tests

Despite the inherent risks of cementing the long-string production casing in the conditions at Macondo, BP did not carry out a number of critical tests (e.g., fully testing setting time and cement compatibility with drilling fluid) before or after pumping the cement. Post-incident testing by both CSI Technologies and Chevron demonstrated that the nitrified cement slurry used at Macondo likely failed.

Cement Contamination

Contrary to best practices, BP decided not to perform full circulation — or a “bottoms-up” — to condition the drilling fluid in the well before the cement job. A full bottoms-up circulation would have required approximately 2,750 barrels of clean mud to be pumped into the well over about 11.5 hours to keep the ECD under the maximum limit. Instead, BP decided to circulate only 346 barrels to reduce the chance of fracturing the formation, increasing the likelihood that debris remained in the wellbore after circulation.

The failure to run a full bottoms-up, coupled with the fact that drilling mud in the well had not been circulated for more than three days, suggests that cement in the annulus could have channeled and become contaminated. This could have delayed or prevented the cement from setting and developing the required compressive strength. Pre-job testing of the cement and spacer/mud/cement compatibility was not sufficient to rule out contamination.

Post-Cement Program Review

Testing of the adequacy of the cement program could have identified areas of concern, but was not done. After approving the cement program, BP proceeded with its temporary abandonment plan.

4.4 Temporary Abandonment Procedure

BP's final temporary abandonment plan contained unnecessary risks that were not subjected to formal risk analysis.

BP engineers generated at least five different temporary abandonment plans for the Macondo well between April 12 and April 20, 2010. The plans varied considerably, as did the level of risk they introduced. The abandonment procedure ultimately implemented at Macondo never received the required MMS approval. Further, it was not developed and delivered to the *Deepwater Horizon* until the morning of April 20, 2010, after the rig had commenced temporary abandonment operations. The investigation team found no evidence that BP personnel on the rig or onshore subjected any of the successive temporary abandonment plans or changes to a formal risk assessment process.

The safest of the five versions (that dated April 14) provided that the surface cement plug be set in mud rather than seawater and that a negative pressure test be conducted before the drilling mud was displaced with seawater. The plan that was finally implemented lacked both of these features.

The most significant deficiency in the final plan was the cumulative lack of barriers to flow. The final plan required displacing the drilling mud to a depth of 8,367 ft. (approximately 3,300 ft. below the mudline), which was much greater than the normal displacement depth of between zero and 1,000 ft below the mudline. In addition, the plan removed the mud before testing the cement barrier with a negative pressure test and before setting the surface cement plug. As a result, no secondary cement barrier was in place during the negative pressure test and displacement.

4.5 Displacement

The initial displacement was planned incorrectly, and the execution did not meet the objective of allowing for a valid negative pressure test.

The final temporary abandonment plan required displacing the casing annulus below the annular blowout preventer (BOP) with seawater to achieve the desired negative pressure test conditions. However, post-incident analysis determined that this objective was not achieved because of calculation errors in the final displacement procedure, lower pump efficiencies which may have been caused by the unconventional spacer materials, potential downhole losses, and the movement of spacer below the closed annular. These factors resulted in a large volume of spacer in the annulus during the negative pressure test that went unidentified due to inadequate fluid volume tracking and lack of procedures to identify the appropriate pressure readings for a satisfactory initial test configuration.

With heavy spacer in the annulus below the closed annular BOP, a valid negative pressure test could not be achieved by monitoring the kill line, which was the method BP decided to use.

4.6 Negative Pressure Test

The results of the negative pressure test were misinterpreted. After the test, BP decided to proceed with the final displacement.

A negative pressure test is necessary to confirm that the cement will block flow from the reservoir into the well after mud is replaced with seawater. There is no established industry standard or MMS procedure for performing a negative pressure test, and procedures vary from well to well. At Macondo, BP was responsible for overseeing the test and determining if the test was successful.

Post-incident analyses confirmed that the test failed. Anomalous pressure observed on the drill pipe during the test should have alerted all of those monitoring the well to the fact that the cement barrier was not effective, that pressure was being transmitted past the cement and float equipment, and that the well was in communication with the formations.

Central to the misinterpretation of the test results was BP's decision to monitor the kill line instead of the drill pipe when conducting the test. Had the drill crew continued monitoring flow from the drill pipe, as they had been doing previously, those monitoring the well would have detected flow indicating that the well was in communication with the formation.

4.7 Sheen Test and Final Displacement

Post-incident analysis indicated a change in flow path from the well during the final displacement masked influxes into the wellbore.

Following its approval of the negative pressure test, BP directed the drill crew to proceed with displacing the riser with seawater and, when the spacer was expected at the surface, to stop operations for a sheen test.

Replacing the heavier drilling mud with lighter-weight seawater during final displacement eliminated the remaining hydrostatic barrier to flow, leaving the inadequate cement barrier at the bottom of the well as the primary barrier. According to post-incident calculations, the well became underbalanced to one or more of the exposed formations sometime between 8:38 p.m. and 8:52 p.m., but there was no clear indication of an influx at that time.

Just before the pumps were shut down for the sheen test, the trip tank was dumped into the flowline to send oil-based mud back to the mud pits. Based on post-incident analysis, the resulting increase in flow from the trip tank across the flow sensors masked an influx into the well.

More than one individual on the rig indicated the well was not flowing when the mud pumps were shut down for the sheen test. It is possible that no flow was seen because the flow path had been changed to overboard to dispose of the spacer before the visual confirmations. Post-incident data analysis shows that hydrocarbons flowed into the well during the sheen test, but the overboard discharge may have masked the flow.

Although the compliance engineer concluded and reported that the sheen test was successful, post-incident analysis indicates that the spacer had not reached the surface at the time the test was conducted. This report gave the driller an erroneous confirmation that the displacement was on track when, in fact, it was not.

Pump operations following the sheen test masked an underlying trend of increasing pressure which resulted from an influx into the well. It is not known what data the drill crew was monitoring or why they did not detect an anomaly until approximately 9:30 p.m. At that time, the drill crew acted upon a differential pressure anomaly between the kill line and drill pipe. Actions taken indicate behaviors consistent with a belief that the well was secure and a plug existed in the well. At 9:42 p.m., the pressure trend provided a conventional influx indication with a drop in pressure. At that time a flow check was completed on the trip tank and well control action followed.

4.8 Activation of the BOP

The BOP functioned and closed but was overcome by well conditions.

The *Deepwater Horizon* BOP and electro-hydraulic/multiplex (MUX) control system were fully operational at the time of the incident, and the equipment functioned. The equipment was maintained in accordance with Transocean requirements, and all modifications that had been made to the BOP either maintained or improved the performance of the device. Minor leaks identified pre-incident did not adversely affect the functionality of the BOP for well control.

Upon detecting flow, the drill crew shut in the well by (1) closing the upper annular BOP; (2) closing the diverter packer and diverting the flow to the mud-gas separator; and, (3) closing the upper and middle VBRs, which initially sealed the well.

However, because of the high flow rate of hydrocarbons from the well, the annular BOP element did not seal and the concentrated flow eroded the drill pipe just above the annular. The closing of the VBRs isolated the annular space and temporarily stopped the influx, but increased pressure inside the drill pipe until it ruptured at

the point of erosion above the upper annular. The ruptured drill pipe allowed hydrocarbons to again flow into the riser. When the *Deepwater Horizon* lost power and drifted off location, the drill pipe parted fully.

The explosions and fire disabled the communication link between the BOP and the rig, preventing activation of the BOP emergency disconnect system (EDS) from the toolpusher control panel.

The automatic mode function (AMF) operated as designed to close the blind shear rams following the explosion. However, high pressure bowed the drill pipe partially outside of the BSR shearing blades, trapping it between the ram blocks and preventing the BSR's from completely shearing the pipe, fully closing, and sealing the well.

4.9 Muster and Evacuation

All personnel who survived the explosions made their own way or were assisted to the forward lifeboat muster station and successfully evacuated the rig. Despite the obstacles and challenges, the muster and evacuation plans and training facilitated the evacuation of all 115 survivors.

The Macondo incident created extremely challenging conditions for everyone onboard. The explosions and fire happened in the evening, when many off-tour crew were asleep or in their cabins. The blast damage blocked some normal muster points. Some crew were injured and could not evacuate without assistance. It appears that, under the stress of the emergency, four persons evacuated independently rather than pursuant to the procedure in which they were trained.

Despite these obstacles and challenges, the muster and evacuation plans and training facilitated the evacuation of all 115 survivors to the *Damon B. Bankston* supply vessel nearby. One hundred people evacuated in the forward lifeboats, seven evacuated in one of the forward life rafts, and eight jumped from the forward end of the rig into the ocean and were recovered by the *Bankston* fast rescue craft (FRC). After the survivors reached the *Bankston*, the 17 most seriously injured survivors were airlifted by USCG helicopters to hospitals for treatment.

In addition to the heroic actions of many of the crew, assistance from the crew of the *Bankston* was critical in the evacuation and rescue effort.

The members of the Transocean Internal Investigation Team dedicate their work and report to the 11 crew members who lost their lives on April 20, 2010, and the families and friends of everyone affected by this tragedy.

Glossary

ABS	American Bureau of Shipping	DPO	dynamic positioning operator
AMF	automatic mode function	DTD	diverter test device
API	American Petroleum Institute	DWS	driller's work station
APM	application for permit to modify	ECD	equivalent circulating density
ASME	American Society of Mechanical Engineers	ECR	engine control room
Bankston	<i>Damon B. Bankston</i>	EDS	emergency disconnect system
bbl	barrel or barrels	ESD	emergency shutdown
Bc	Bearden units of consistency	°F	degrees Fahrenheit
BHCT	bottom hole circulating temperature	FRC	fast rescue craft
BHST	bottom hole static temperature	ft.	foot or feet
BML	below mud line	gal	gallons
BOEMRE	Bureau of Ocean Energy Management, Regulation and Enforcement; formerly MMS	GMDSS	Global Maritime Distress Safety System
BOP	blowout preventer	gps	gallons per sack
bpm	barrels per minute	H₂S	hydrogen sulfide
BSR	blind shear ram	Hitec	NOV Hitec Cyberbase drilling rig control system
°C	degrees Celsius	HP	high pressure
C.F.R.	Code of Federal Regulations	HPHT	high pressure/high temperature
CBL	cement bond log	HVAC	heating, ventilation, and air conditioning
CCTV	closed-circuit television	HWDP	heavyweight drill pipe
CSR	casing shear ram	IADC	International Association of Drilling Contractors
DC	direct current	in.	inch or inches
DCP	driller's control panel	KCl	potassium chloride
DER	driller's equipment room	lb.	pound or pounds
DP	dynamically positioned	lbf	pounds (force)
		LCM	lost-circulation material

LIT	lead impression tool	ppg	pounds per gallon
LMRP	lower marine riser package	psi	pounds per square inch
LWD	Logging While Drilling	PWD	Pressure While Drilling
MAYDAY	emergency code word used as a distress signal	ROV	remotely operated vehicle
Marshall Islands (MI)	Republic of the Marshall Islands, the flag state of the <i>Deepwater Horizon</i>	RTE	rotary table elevation
MC252	Mississippi Canyon block 252, where the Macondo prospect is located	SBM	synthetic-based mud
MD	measured depth	SEM	subsea electronic module
MGS	mud-gas separator	sk	sack
MMS	Minerals Management Service, now BOEMRE	SOBM	synthetic oil-based mud
MOC	management of change	SOLAS	International Standards of Safety of Life at Sea (1974)
MODU	mobile offshore drilling unit	SSP	selected standpipe (drill pipe) pressure
MOU	mobile offshore unit	SSS	Simrad Safety System
MUX	multiplex	ST Lock	hydro-mechanical ram locking mechanism
MWD	Measurement While Drilling	STM	subsea transducer module
NDT	non-destructive testing	SVC	Simrad Vessel Control
No	number	TA	temporary abandonment
OBM	oil-based mud	TD	total depth
OCS	outer continental shelf	TVD	total vertical depth
OD	outside diameter	UCA	ultrasonic cement analyzer
OEM	original equipment manufacturer	USCG	United States Coast Guard
OIM	offshore installation manager	V	volt
PA	public address	VBR	variable bore ram
PETU	portable electronic test unit	VHF	very-high frequency radio
PLC	Programmable Logic Controller		

