

**THE BUREAU OF OCEAN ENERGY MANAGEMENT,  
REGULATION AND ENFORCEMENT**



**REPORT REGARDING THE CAUSES OF THE APRIL 20, 2010  
MACONDO WELL BLOWOUT**

**September 14, 2011**

## TABLE OF CONTENTS

|   |    |
|---|----|
| Executive Summary .....   | 1  |
| I. Introduction .....   | 10 |
| A. <i>The Investigation</i> .....   | 10 |
| B. <i>Background Regarding Deepwater Drilling in the Gulf of Mexico</i> ..... | 13 |
| C. <i>Companies Involved in the Macondo Well</i> .....                        | 16 |
| D. <i>The Deepwater Horizon</i> .....   | 18 |
| E. <i>The Macondo Well</i> .....  | 19 |
| F. <i>The Blowout</i> .....   | 23 |
| II. Well Design .....   | 25 |
| A. <i>Cost of the Macondo Well</i> .....                                      | 25 |
| B. <i>Drilling Margin</i> .....   | 27 |
| C. <i>Casing Program</i> .....  | 31 |
| D. <i>Mud Program and Type</i> .....  | 32 |
| E. <i>Mud Losses</i> .....  | 33 |
| F. <i>Well Ballooning</i> .....   | 34 |
| G. <i>Planned and Actual Total Depth</i> .....                                | 34 |
| H. <i>Designing the Production Casing – Long String versus Liner</i> .....    | 36 |
| III. Cementing .....  | 40 |
| A. <i>Cementing Process</i> .....   | 40 |
| B. <i>Cement Design and Modeling</i> .....                                    | 41 |
| C. <i>Gas Flow Potential</i> .....  | 46 |
| D. <i>Centralizers</i> .....  | 47 |
| E. <i>Float Collar</i> .....  | 49 |
| F. <i>Cementing the Macondo Production Casing</i> .....                       | 53 |
| G. <i>Industry Standards for Cementing</i> .....                              | 57 |
| IV. Possible Flow Paths .....   | 61 |
| V. Conclusions on Well Design, Cementing, and Flow Path .....                 | 68 |
| A. <i>Cause of the Failure of the Cement Barrier</i> .....                    | 68 |
| B. <i>Contributing Causes of the Cement Barrier Failure</i> .....             | 68 |
| C. <i>Possible Contributing Causes of the Cement Barrier Failure</i> .....    | 70 |
| D. <i>Flow Path Cause</i> .....   | 73 |
| VI. Challenges at the Macondo Well .....                                      | 75 |
| A. <i>Kicks and Stuck Drill Pipe</i> .....                                    | 75 |
| B. <i>Scheduling Conflicts and Cost Overruns</i> .....                        | 78 |
| C. <i>Personnel Changes and Conflicts</i> .....                               | 79 |
| D. <i>Safety Stand-down</i> .....   | 83 |
| VII. Temporary Abandonment of the Macondo Well .....                          | 85 |

|       |  |     |
|-------|--|-----|
| A.    | <i>Installing the Lock-Down Sleeve</i> .....   | 85  |
| B.    | <i>Setting the Cement Plug</i> .....   | 86  |
| C.    | <i>The Use of Lost Circulation Material as Spacer</i> .....                                    | 87  |
| D.    | <i>Well Integrity Testing</i> .....  | 88  |
| VIII. | <i>Kick Detection and Rig Response</i> .....   | 98  |
| A.    | <i>Kick Detection Methods and Responsibilities</i> .....                                       | 98  |
| B.    | <i>Multiple Simultaneous Operations That Hampered the Crew’s Ability to Detect Kicks</i> ..... | 99  |
| C.    | <i>Rig Floor Response</i> .....  | 103 |
| D.    | <i>The Use of the Mud Gas Separator</i> .....  | 104 |
| E.    | <i>Activity on the Bridge</i> .....  | 106 |
| F.    | <i>Emergency Disconnect System</i> .....   | 107 |
| IX.   | <i>Conclusions on Temporary Abandonment, Kick Detection, and the Emergency Response</i> .....  | 109 |
| A.    | <i>Kick Detection and Response Failure Cause</i> .....   | 109 |
| B.    | <i>Kick Detection Failure Contributing Causes</i> .....  | 109 |
| C.    | <i>Kick Detection Failure Possible Contributing Causes</i> .....                               | 110 |
| D.    | <i>Response Failure Contributing Causes</i> .....  | 112 |
| E.    | <i>Response Failure Possible Contributing Causes</i> .....                                     | 113 |
| X.    | <i>Ignition Source(s) and Explosions</i> .....   | 115 |
| A.    | <i>Main Engines and Engine Switch Gear Rooms</i> .....   | 115 |
| B.    | <i>Mud Gas Separator</i> .....   | 119 |
| C.    | <i>Other Possible Ignition Sources</i> .....   | 122 |
| XI.   | <i>Conclusions on Ignition Source and Explosion</i> .....                                      | 125 |
| A.    | <i>Ignition Sources</i> .....  | 125 |
| B.    | <i>Contributing Causes of the Explosion</i> .....  | 125 |
| C.    | <i>Possible Contributing Causes of the Explosion</i> .....                                     | 126 |
| D.    | <i>Other Possible Ignition Sources</i> .....   | 127 |
| XII.  | <i>The Deepwater Horizon BOP Stack</i> .....   | 129 |
| A.    | <i>Design and Configuration</i> .....  | 129 |
| B.    | <i>Control and Power Systems</i> .....   | 132 |
| C.    | <i>Emergency Disconnect System</i> .....   | 133 |
| D.    | <i>Automatic Mode Function (“Deadman”)</i> .....   | 134 |
| E.    | <i>Autoshear Function</i> .....  | 134 |
| F.    | <i>Forensic Examination of the BOP</i> .....   | 135 |
| G.    | <i>Examination Methods Used by DNV</i> .....   | 137 |
| H.    | <i>DNV’s Forensic Examination Findings</i> .....   | 138 |
| I.    | <i>Evaluation of Other Possible Failures</i> .....   | 142 |
| J.    | <i>Studies Evaluating the Reliability of BOPs</i> .....  | 144 |
| K.    | <i>Maintenance of the Deepwater Horizon BOP</i> .....  | 146 |

|        |  |     |
|--------|--|-----|
| L.     | <i>BOP System Leaks</i> .....  | 151 |
| M.     | <i>ROV Interventions</i> .....   | 153 |
| XIII.  | <i>BOP Stack Conclusions</i> .....   | 155 |
| A.     | <i>Cause of the BOP Stack Failure</i> .....                                | 155 |
| B.     | <i>BOP Stack Failure Contributing Causes</i> .....                         | 155 |
| C.     | <i>BOP Stack Failure Possible Contributing Causes</i> .....                | 155 |
| XIV.   | <i>Regulatory Findings</i> .....   | 157 |
| A.     | <i>Permitting Process</i> .....  | 158 |
| B.     | <i>Well Activity Reports</i> .....   | 161 |
| C.     | <i>Macondo Departures and Alternative Procedures</i> .....                 | 161 |
| D.     | <i>MMS Drilling Inspections</i> .....                                      | 162 |
| E.     | <i>Potential Incident of Noncompliance Guidelines</i> .....                | 162 |
| F.     | <i>Inspection Forms</i> .....  | 164 |
| G.     | <i>MMS Deepwater Horizon Inspections at MC 252</i> .....                   | 164 |
| H.     | <i>Safe Drilling Margin</i> .....  | 165 |
| I.     | <i>Well Control</i> .....  | 165 |
| J.     | <i>Subsea BOP Regulatory Requirements</i> .....                            | 167 |
| K.     | <i>Regulatory Improvements</i> .....                                       | 172 |
| L.     | <i>Incidents of Non-Compliance</i> .....                                   | 173 |
| XV.    | <i>Policies and Practices of Involved Companies</i> .....                  | 175 |
| A.     | <i>BP's Policies and Practices</i> .....                                   | 175 |
| B.     | <i>Transocean's Practices and Procedures</i> .....                         | 185 |
| C.     | <i>BP and Transocean Bridging Document</i> .....                           | 189 |
| D.     | <i>Stop Work Authority</i> .....   | 189 |
| XVI.   | <i>Conclusions Regarding Involved Companies' Practices</i> .....           | 191 |
| XVII.  | <i>Summary of Panel Conclusions</i> .....                                  | 194 |
| A.     | <i>Well Design and Cementing</i> .....                                     | 194 |
| B.     | <i>Flow Path</i> .....   | 195 |
| C.     | <i>Temporary Abandonment, Kick Detection, and Emergency Response</i> ..... | 195 |
| D.     | <i>Ignition Source</i> .....   | 197 |
| E.     | <i>Blowout Preventer</i> .....   | 198 |
| F.     | <i>Company Practices</i> .....   | 199 |
| XVIII. | <i>Conclusion</i> .....  | 200 |
| XIX.   | <i>Recommendations</i> .....   | 202 |
| A.     | <i>Well Recommendations</i> .....  | 202 |
| B.     | <i>Kick Detection and Response Recommendations</i> .....                   | 203 |
| C.     | <i>Ignition Source Recommendations</i> .....                               | 205 |
| D.     | <i>Blowout Preventer Recommendations</i> .....                             | 206 |
| E.     | <i>Regulatory Agency Recommendations</i> .....                             | 207 |
| F.     | <i>OCS Companies' Practices Recommendations</i> .....                      | 209 |

|                      |     |
|----------------------|-----|
| Dedication .....     | 211 |
| Acknowledgement..... | 212 |

## Executive Summary

---

At approximately 9:50 p.m. on the evening of April 20, 2010, while the crew of the *Deepwater Horizon* rig was finishing work after drilling the Macondo exploratory well, an undetected influx of hydrocarbons (commonly referred to as a “kick”) escalated to a blowout. Shortly after the blowout, hydrocarbons that had flowed onto the rig floor through a mud-gas vent line ignited in two separate explosions. Flowing hydrocarbons fueled a fire on the rig that continued to burn until the rig sank on April 22. Eleven men died on the *Deepwater Horizon* that evening. Over the next 87 days, almost five million barrels of oil were discharged from the Macondo well into the Gulf of Mexico.<sup>1</sup>

After an extensive investigation conducted by the Joint Investigation Team of the Bureau of Ocean Energy Management, Regulation and Enforcement (“BOEMRE”) (formerly the Minerals Management Service or “MMS”) and the United States Coast Guard, the BOEMRE panel of investigators (“the Panel”) has identified a number of causes of the Macondo blowout.

The Panel found that a central cause of the blowout was failure of a cement barrier in the production casing string, a high-strength steel pipe set in a well to ensure well integrity and to allow future production. The failure of the cement barrier allowed hydrocarbons to flow up the wellbore, through the riser and onto the rig, resulting in the blowout. The precise reasons for the failure of the production casing cement job are not known. The Panel concluded that the failure was likely due to: (1) swapping of cement and drilling mud (referred to as “fluid inversion”) in the shoe track (the section of casing near the bottom of the well); (2) contamination of the shoe track cement; or (3) pumping the cement past the target location in the well, leaving the shoe track with little or no cement (referred to as “over-displacement”).

The loss of life at the Macondo site on April 20, 2010, and the subsequent pollution of the Gulf of Mexico through the summer of 2010 were the result of poor risk management, last-minute changes to plans, failure to observe and respond to critical indicators, inadequate well control response, and insufficient

---

<sup>1</sup> This estimate is based upon pressure readings, data, and analysis conducted by U.S. scientific teams commissioned by the National Incident Commander. *See* <http://www.doi.gov/news/pressreleases/US-Scientific-Teams-Refine-Estimates-of-Oil-Flow-from-BP-Well-Prior-to-Capping.cfm>.

emergency bridge response training by companies and individuals responsible for drilling at the Macondo well and for the operation of the *Deepwater Horizon*.

BP, as the designated operator under BOEMRE regulations, was ultimately responsible for conducting operations at Macondo in a way that ensured the safety and protection of personnel, equipment, natural resources, and the environment. Transocean, the owner of the *Deepwater Horizon*, was responsible for conducting safe operations and for protecting personnel onboard. Halliburton, as a contractor to BP, was responsible for conducting the cement job, and, through its subsidiary (Sperry Sun), had certain responsibilities for monitoring the well. Cameron was responsible for the design of the *Deepwater Horizon* blowout preventer (“BOP”) stack.

At the time of the blowout, the rig crew was engaged in “temporary abandonment” activities to secure the well after drilling was completed and before the *Deepwater Horizon* left the site. In the days leading up to April 20, BP made a series of decisions that complicated cementing operations, added incremental risk, and may have contributed to the ultimate failure of the cement job. These decisions included:

- *The use of only one cement barrier.* BP did not set any additional cement or mechanical barriers in the well, even though various well conditions created difficulties for the production casing cement job.
- *The location of the production casing.* BP decided to set production casing in a location in the well that created additional risk of hydrocarbon influx.
- *The decision to install a lock-down sleeve.* BP’s decision to include the setting of a lock-down sleeve (a piece of equipment that connects and holds the production casing to the wellhead during production) as part of the temporary abandonment procedure at Macondo increased the risks associated with subsequent operations, including the displacement of mud, the negative test sequence and the setting of the surface plug.
- *The production casing cement job.* BP failed to perform the production casing cement job in accordance with industry-accepted recommendations.

The Panel concluded that BP failed to communicate these decisions and the increasing operational risks to Transocean. As a result, BP and Transocean

personnel onboard the *Deepwater Horizon* on the evening of April 20, 2010, did not fully identify and evaluate the risks inherent in the operations that were being conducted at Macondo.

On April 20, BP and Transocean personnel onboard the *Deepwater Horizon* missed the opportunity to remedy the cement problems when they misinterpreted anomalies encountered during a critical test of cement barriers called a negative test, which seeks to simulate what will occur at the well after it is temporarily abandoned and to show whether cement barrier(s) will hold against hydrocarbon flow.

The rig crew conducted an initial negative test on the production casing cement job that showed a pressure differential between the drill pipe and the kill line, which is a high-pressure pipe leading from the BOP stack to the rig pumps. This was a serious anomaly that should have alerted the rig crew to potential problems with the cement barrier or with the negative test. After some discussion among members of the crew and a second negative test on the kill line, the rig crew explained the pressure differential away as a “bladder effect,” a theory that later proved to be unfounded. Around 7:45 p.m., after observing for 30 minutes that there was no flow from the kill line, the rig crew concluded that the negative test was successful. At this point, the rig crew most likely concluded that the production casing cement barrier was sound.

The cement in the shoe track barrier, however, had in fact failed, and hydrocarbons began to flow from the Macondo reservoir into the well. Despite a number of additional anomalies that should have signaled the existence of a kick or well flow, the crew failed to detect that the well was flowing until 9:42 p.m. By then it was too late – the well was blowing drilling mud up into the derrick and onto the rig floor. If members of the rig crew had detected the hydrocarbon influx earlier, they might have been able to take appropriate actions to control the well. There were several possible reasons why the *Deepwater Horizon* crew did not detect the kick:

- *The rig crew had experienced problems in promptly detecting kicks.* The *Deepwater Horizon* crew had experienced a kick on March 8, 2010 that went undetected for approximately 30 minutes. BP did not conduct an investigation into the reasons for the delayed detection of the kick. Transocean personnel admitted to BP that individuals associated with the March 8 kick had “screwed up by not catching” the kick. Ten of the 11



individuals on duty on March 8, who had well control responsibilities, were also on duty on April 20.

- *Simultaneous rig operations hampered the rig crew's well monitoring abilities.* The rig crew's decision to conduct simultaneous operations during the critical negative tests - including displacement of fluids to two active mud pits and cleaning the pits in preparation to move the rig - complicated well-monitoring efforts.
- *The rig crew bypassed a critical flow meter.* At approximately 9:10 p.m., the rig crew directed fluid displaced from the well overboard, which bypassed the Sperry Sun flow meter, which is a critical kick detection tool that measures outflow from the well. The *Deepwater Horizon* was equipped with other flow meters, but the Panel found no evidence that these meters were being monitored prior to the blowout.

Once the crew discovered the hydrocarbon flow, it sent the flow to a mud-gas separator, a piece of equipment not designed to handle high flow rates. The mud-gas separator could not handle the volume of hydrocarbons, and it discharged a gas plume above the rig floor that ignited.

The Panel found evidence that the configuration of the *Deepwater Horizon* general alarm system and the actions of rig crew members on the bridge of the rig contributed to a delay in notifying the entire crew of the presence of very high gas levels on the rig. Transocean had configured the *Deepwater Horizon's* general alarm system in "inhibited" mode, which meant that the general alarm would not automatically sound when multiple gas alarms were triggered in different areas on the rig. As a result, personnel on the bridge were responsible for sounding of the general alarm. Personnel on the bridge waited approximately 12 minutes after the sounding of the initial gas alarms to sound the general alarm, even though they had been informed that a "well control problem" was occurring. During this period, there were approximately 20 alarms indicating the highest level of gas concentration in different areas on the rig.

The *Deepwater Horizon's* BOP stack, a massive, 360-ton device installed at the top of the well, was designed to allow the rig crew to handle numerous types of well control events. However, on April 20, the BOP stack failed to seal the well to contain the flow of hydrocarbons. The explosions likely damaged the *Deepwater Horizon's* multiplex cables and hydraulic lines, rendering the crew

unable to activate the BOP stack. The BOP stack was equipped with an “automatic mode function,” which upon activation would trigger the blind shear ram (BSR), two metal blocks with blades on the inside edges that are designed to cut through the drill pipe and seal the well during a well control event.

The Panel concluded that there were two possible ways in which the BSR might have been activated: (1) on April 20, by the automatic mode function, immediately following loss of communication with the rig; or (2) on April 22, when a remotely operated vehicle triggered the “autoshear” function, which is designed to close the BSR if the lower marine riser package disconnects from the rest of the BOP stack. Regardless of how the BSR was activated, it did not seal the well.

A forensic examination of the BOP stack revealed that elastic buckling of the drill pipe had forced the drill pipe up against the side of the wellbore and outside the cutting surface of the BSR blades. As a result, the BSR did not completely shear the drill pipe and did not seal the well. The buckling of the drill pipe, which likely occurred at or near the time when control of the well was lost, was caused by the force of the hydrocarbons blowing out of the well; by the weight of the 5,000 feet of drill pipe located in the riser above the BOP forcing the drill pipe down into the BOP stack; or by a combination of both. As a result of the failure of the BSR to completely cut the drill pipe and seal the well, hydrocarbons continued to flow after the blowout.

Prior to the events of April 20, BP and Transocean experienced a number of problems while conducting drilling and temporary abandonment operations at Macondo. These problems included:

- *Recurring well control events and delayed kick detection.* At least three different well control events and multiple kicks occurred during operations at Macondo. On March 8, it took the rig crew at least 30 minutes to detect a kick in the well. The delay raised concerns among BP personnel about the *Deepwater Horizon* crew’s ability to promptly detect kicks and take appropriate well control actions. Despite these prior problems, BP did not take steps to ensure that the rig crew was better equipped to detect kicks and to handle well control events. As of April 20, Transocean had not completed its investigation into the March 8 incident.
- *Scheduling conflicts and cost overruns.* At the time of the blowout, operations at Macondo were significantly behind schedule. BP had

initially planned for the *Deepwater Horizon* to move to BP's Nile well by March 8, 2010. In large part as a result of this delay, as of April 20, BP's Macondo operations were more than \$58 million over budget.

- *Personnel changes and conflicts.* BP experienced a number of problems involving personnel with responsibility for operations at Macondo. A reorganization that took place in March and April 2010 changed the roles and responsibilities of at least nine individuals with some responsibility for Macondo operations. In addition, the Panel found evidence of a conflict between the BP drilling and completions operations manager and the BP wells team leader and evidence of a failure to adequately delineate roles and responsibilities for key decisions.

At the time of the blowout, both BP and Transocean had extensive procedures in place regarding safe drilling operations. BP required that its drilling and completions personnel follow a "documented and auditable risk management process." The Panel found no evidence that the BP Macondo team fully evaluated ongoing operational risks, nor did it find evidence that BP communicated with the Transocean rig crew about such risks.

Transocean had a number of documented safety programs in place at the time of the blowout. Nonetheless, the Panel found evidence that Transocean personnel questioned whether the *Deepwater Horizon* crew was adequately prepared to independently identify hazards associated with drilling and other operations.

Everyone on board the *Deepwater Horizon* was obligated to follow the Transocean "stop work" policy that was in place on April 20, which provided that "[e]ach employee has the obligation to interrupt an operation to prevent an incident from occurring." Despite the fact that the Panel identified a number of reasons that the rig crew could have invoked stop work authority, no individual on the *Deepwater Horizon* did so on April 20.

The Panel found evidence that BP and, in some instances, its contractors violated the following federal regulations:

- 30 CFR § 250.107 – BP failed to protect health, safety, property, and the environment by (1) performing all operations in a safe and workmanlike manner; and (2) maintaining all equipment and work areas in a safe condition;

- 30 CFR § 250.300 – BP, Transocean, and Halliburton (Sperry Sun) failed to take measures to prevent the unauthorized release of hydrocarbons into the Gulf of Mexico and creating conditions that posed unreasonable risk to public health, life, property, aquatic life, wildlife, recreation, navigation, commercial fishing, or other uses of the ocean;
- 30 CFR § 250.401 – BP, Transocean, and Halliburton (Sperry Sun) failed to take necessary precautions to keep the well under control at all times;
- 30 CFR § 250.420(a)(1) and (2) – BP and Halliburton failed to cement the well in a manner that would properly control formation pressures and fluids and prevent the release of fluids from any stratum through the wellbore into offshore waters;
- 30 CFR § 250.427(a) – BP failed to use pressure integrity test and related hole-behavior observations, such as pore pressure test results, gas-cut drilling fluid, and well kicks to adjust the drilling fluid program and the setting depth of the next casing string;
- 30 CFR § 250.446(a) – BP and Transocean failed to conduct major inspections of all BOP stack components; and
- 30 CFR § 250.1721(a) – BP failed to perform the negative test procedures detailed in an application for a permit to modify its plans.

Although the Panel found no evidence that MMS regulations in effect on April 20, 2010 were a cause of the blowout, the Panel concluded that stronger and more comprehensive federal regulations might have reduced the likelihood of the Macondo blowout. In particular, the Panel found that MMS regulations in place at the time of the blowout could be enhanced in a number of areas, including: cementing procedures and testing; BOP configuration and testing; well integrity testing; and other drilling operations. In addition, the Panel found that there were a number of ways in which the MMS drilling inspections program could be improved. For example, the Panel concluded that drilling inspections should evaluate emergency disconnect systems and/or other BOP stack secondary system functions. BOEMRE has already implemented many of these improvements.

This Report sets forth in detail the Panel's investigative findings, conclusions, and recommendations. The Panel's findings and conclusions are presented in the following subject areas: well design; cementing; possible flow paths; temporary abandonment of the Macondo well; kick detection and rig response; ignition source and explosion; the failure of the *Deepwater Horizon* blowout preventer; regulatory findings and conclusions; and company practices.

This Report concludes with the Panel's recommendations, which seek to improve the safety of offshore drilling operations in a variety of different ways:

- *Well design.* Improved well design techniques for wells with high flow potential, including increasing the use of mechanical and cement barriers, will decrease the chances of a blowout.
- *Well integrity testing.* Better well integrity test practices (e.g., negative test practices) will allow rig crews to identify possible well control problems in a timely manner.
- *Kick detection and response.* The use of more accurate kick detection devices and other technological improvements will help to ensure that rig crews can detect kicks early and maintain well control. Better training also will allow rig crews to identify situations where hydrocarbons should be diverted overboard.
- *Rig engine configuration (air intake locations).* Assessment and testing of safety devices, particularly on rigs where air intake locations create possible ignition sources, may decrease the likelihood of explosions and fatalities in the event of a blowout.
- *Blowout preventers.* Improvements in BOP stack configuration, operation, and testing will allow rig crews to be better able to handle well control events.
- *Remotely-operated vehicles (ROVs).* Standardization of ROV intervention panels and intervention capabilities will allow for improved response during a blowout.

The Panel believes that the adoption of the proposed recommendations will improve the safety of offshore operations and will help to reduce the

likelihood of the occurrence of another tragic event similar to the Macondo blowout.

## I. Introduction

### A. *The Investigation*

On April 27, 2010, the Secretaries of the Department of Homeland Security and the Department of the Interior convened a joint investigation of “the explosion and sinking of the mobile offshore drilling unit *Deepwater Horizon*”<sup>2</sup> by the Bureau of Ocean Energy Management, Regulation and Enforcement (“BOEMRE”) and the United States Coast Guard (“USCG”). The Convening Order directed the Joint Investigation Team (“JIT”) to issue a joint report within nine months. This deadline was extended to allow the JIT to complete the investigation.

On April 29, 2010, an MMS Associate Director appointed the MMS (now BOEMRE) members of the JIT.<sup>3</sup> This Report is based on the investigative record developed by the JIT and contains the Panel’s findings and conclusions. BOEMRE’s Investigations and Review Unit (“IRU”), in close coordination with the Panel, had a substantial role in the drafting and preparation of the Report.<sup>4</sup>

The Convening Order provides that relevant statutes and regulations relating to both the USCG and BOEMRE govern the JIT and that the JIT’s public hearings be conducted in accordance with the USCG’s rules and procedures relating to Marine Boards of Investigation. Under these rules, the JIT was required to formally designate certain companies and individuals involved with the *Deepwater Horizon* operation at the time of the blowout as “parties in interest” (“PIIs”) and also retained the authority to designate other PIIs at its discretion. The JIT designated the following entities and individuals as PIIs: BP, Transocean, Halliburton, MI-SWACO, Weatherford, Anadarko Petroleum, MOEX USA Corp., Dril-Quip, Jimmy Harrell (Transocean), Curt Kuchta (Transocean), Douglas Harold Brown (Transocean), Steve Bertone (Transocean), Mike Williams

---

<sup>2</sup> Joint Department of the Interior and Department of Homeland Security Statement of Principles and Convening Order Regarding Investigation into the Marine Casualty, Explosion, Fire, Pollution, and Sinking of Mobile Offshore Drilling Unit *Deepwater Horizon*, with Loss of Life in the Gulf of Mexico, April 21-22, 2010 (the “Convening Order”). By order of the Secretary of the Interior, dated June 18, 2010, BOEMRE replaced the former Minerals Management Service (“MMS”) as the United States’ offshore resource manager and safety authority.

<sup>3</sup> Panel members included David Dykes (co-chair), Glynn Breaux, John McCarroll, Kirk Malstrom, and Jason Mathews.

<sup>4</sup> IRU members included Michael Farber, Lisa Scanlon, and Kishan Nair.

(Transocean), Patrick O'Bryan (BP), and Robert Kaluza (BP).<sup>5</sup> Under the Marine Board rules and other governing authorities, the PII's possessed certain rights relating to the investigation.<sup>6</sup>

Under the Convening Order, the JIT was given the full investigative authority of both the Department of the Interior and the Department of Homeland Security.<sup>7</sup> The JIT held seven public hearings and heard testimony from more than 80 witnesses.<sup>8</sup> Three witnesses whose testimony was sought by the JIT invoked their Fifth Amendment rights against self-incrimination and refused to testify during the JIT hearings, and two other witnesses claimed they were unable to testify for medical reasons.<sup>9</sup> In addition to the public hearings, BOEMRE investigators also conducted interviews of more than 25 individuals throughout the investigation.

The JIT collected and reviewed large volumes of electronic and written material, including data, emails and other records related to the PII's' equipment, management systems, supervision of employees and contractors, communications, performance and training of personnel, relevant company policies and practices, and work environment. The JIT issued more than 90 subpoenas for documents and other information and collected over 400,000 pages of evidence.

During the course of the investigation, the JIT commissioned several entities and qualified individuals to conduct expert analyses of evidence. Dr. John Smith, a petroleum engineer with Petroleum Consulting LLC, reviewed

---

<sup>5</sup> At the request of the Republic of the Marshall Islands, the JIT designated it as a "Substantially Interested State." The *Deepwater Horizon* was a foreign-flagged vessel that, at the time of the blowout, was flagged under the Republic of the Marshall Islands.

<sup>6</sup> See 46 U.S.C. § 6303; 46 CFR. §§ 4.03-10, 4.07-35, 4.09-15.

<sup>7</sup> Convening Order, at 1.

<sup>8</sup> Retired United States District Judge Wayne Andersen, who served without compensation, joined the JIT in August 2010 to preside over subsequent hearings. BOEMRE is grateful for Judge Andersen's assistance during the hearings and in meetings with counsel for the PII's.

<sup>9</sup> Brian Morel and Robert Kaluza each invoked his Fifth Amendment Rights and refused to testify during JIT hearings. After testifying at one hearing, Mark Hafle invoked his Fifth Amendment Rights and refused to testify a second time. Through his attorney, Donald Vidrine claimed that he could not testify due to medical reasons. Each of these four individuals was a BP employee at the time of the blowout and continues to be employed by BP. In addition, two Transocean witnesses declined to cooperate with the investigation, citing technical reasons for their decisions not to testify. Transocean declined to encourage these witnesses to cooperate with the investigation.



well condition data collected by Sperry-Sun during the temporary abandonment procedure and reports prepared by the International Association of Drilling Contractors (“IADC”) to help reconstruct and identify key issues during the 24 hours immediately prior to the blowout. Keystone Engineering conducted a casing buoyancy analysis.<sup>10</sup> Oilfield Testing and Consulting conducted a cement blend analysis on samples provided by Halliburton. Det Norske Veritas (“DNV”) conducted the forensic examination of the *Deepwater Horizon’s* BOP stack and sections of drill pipe and provided a forensic analysis report detailing the information and conclusions developed based on this examination.<sup>11</sup> These expert reports are attached as appendices to this Report.

The purpose of this investigation was to identify the causes of the Macondo blowout and issue recommendations in order to reduce the likelihood of a similar event in the future. Throughout this report, the Panel classifies the factors that contributed to the blowout in the following categories:

- **Causes** are those factors that most immediately and proximately caused the blowout; that most directly led to the circumstances underlying the blowout; or that allowed the blowout to happen. But for these factors, there would not have been a blowout. These factors may be specific events or conditions that existed in the well or on the rig at the time of the blowout.
- **Contributing Causes** are those factors that alone would not have led to the blowout, but that were significant in contributing to the events or conditions that gave rise to the blowout. For a factor to be classified as a contributing cause of an event, there must be compelling evidence supporting both the existence of the factor and that it materially contributed to the occurrence or severity of the event.
- **Possible Contributing Causes** are those factors that either were minor contributing causes of the blowout or for which the evidence suggests the factor’s contributing role in the blowout is weaker or less compelling.

---

<sup>10</sup> The casing buoyancy analysis evaluated whether the production casing floated up the wellbore a result of the blowout.

<sup>11</sup> As discussed in more detail later in this report, a BOP stack is a large device that sits on top of a well and is designed to assist rig crews in maintaining control of the well. Various BOP stack components can be manually or automatically operated to seal the well and protect against a blowout. The central issue investigated by the JIT regarding the *Deepwater Horizon* BOP was why the BOP failed to stop the flow of hydrocarbons from the Macondo well.

## ***B. Background Regarding Deepwater Drilling in the Gulf of Mexico***

The goal of deepwater drilling operations is to locate and extract oil and gas (collectively referred to as “hydrocarbons”) from reservoirs located beneath the sea floor. In some reservoirs, the hydrocarbons become trapped beneath impermeable rock; when this happens, the hydrocarbons seep into surrounding porous rock. Drilling operations seek to penetrate the impermeable rock to get to hydrocarbon-bearing reservoirs or “pay zones.”

The Gulf of Mexico is home to a large number of hydrocarbon reservoirs. Since 1947, more than 50,000 wells have been drilled in the U.S. Gulf of Mexico. Approximately 97% of the oil produced on the U.S. Outer Continental Shelf (“OCS”) is produced in the U.S. Gulf of Mexico. There are currently nearly 7,000 active leases in the U.S. Gulf of Mexico, 64% of which are in deepwater.<sup>12</sup>

Since 1995, deepwater drilling activity has increased significantly in the Gulf. In 2001, U.S. deepwater offshore oil production surpassed shallow water offshore oil production for the first time. As of May 2010, operators drilled approximately 700 wells in water depths equal to or greater than 5,000 feet, the approximate depth of the Macondo well.<sup>13</sup> Deepwater reservoirs can yield a high volume of oil and gas. Production rates for deepwater wells are typically much higher than in shallow water wells.

The initial well or wells drilled into a formation are referred to as “exploratory wells,” which an operator drills to determine whether a reservoir contains sufficient volumes of hydrocarbons to warrant investment in the

---

<sup>12</sup> See Department of Interior, Increased Safety Measures for Energy Development on the Outer Continental Shelf, (May 27, 2010). Although there is no single accepted definition of “deepwater,” a common use of the term is to refer to locations where the water depth is at least 1,000 feet.

<sup>13</sup> *Id.* “Operators” are the persons the lessee(s) designates as having control or management of operations on the leased area or a portion thereof. An operator may be a lessee, the MMS-approved designated agent of the lessee(s), or the holder of operating rights under an MMS-approved operating rights assignment. “Lessee” means a person who has entered into a lease with the United States to explore for, develop, and produce the leased minerals. The term lessee also includes the MMS-approved assignee of the lease, and the owner or the MMS-approved assignee of operating rights for the lease. 30 CFR § 250.105.

installation of equipment required for production. At this stage, the operator may have limited information about the geological characteristics of the reservoir and surrounding formations. Such information, including data about the surrounding formations, pore pressures,<sup>14</sup> reservoir configuration and reservoir volumes, is developed during the exploratory drilling operation and may lead to changes in the drilling plan and well design as the operation proceeds.

Once an operator finishes drilling an exploratory well and performing its initial evaluation of the well, it typically seals the well by pumping cement and installing mechanical plugs. This procedure is commonly referred to as “plugging and abandoning” the well. If the operator believes that it eventually will be able to produce hydrocarbons from the exploratory well, it may choose to perform “temporary abandonment” procedures, which are procedures that allow the drilling rig to move off of the well so that the operator can return at a later date to complete the well and prepare it for production.

A typical deepwater well is drilled using the following process:

- A drilling rig moves on the location of the well. Many rigs operating in deepwater are “dynamically-positioned,” which means that they are not moored to the seafloor but instead hold their position over the well through a combination of satellite technology and directional thruster activity. The *Deepwater Horizon* was a dynamically-positioned rig.
- The rig lowers drill pipe (also known as a drill string) with a drill bit attached to its end. The drill bit bores into the sea floor and the subsea formation to make a hole. That hole is referred to as the wellbore.
- The rig installs, or “sets,” a large-diameter pipe known as “casing” into the wellbore to establish a barrier between the wellbore and the surrounding formation and to ensure that continued drilling does not result in the collapse of the wellbore. The initial casing that is set in the wellbore is called “conductor” casing.
- The rig then uses the “marine riser” or “riser,” which is a large pipe that surrounds the drill pipe, to lower the subsea BOP stack onto the well. The subsea BOP is latched to the wellhead on the conductor casing.

---

<sup>14</sup> “Pore pressure” is the pressure of fluids within the pores of a reservoir.

- As drilling progresses, the rig sets additional casings (sections of pipe) that are slightly smaller in diameter than the hole created by the drill bit. The combination of casings is referred to as the “casing string.” The casings are bonded into place using cement. The casing string maintains the integrity of the wellbore by protecting the sides of the wellbore from: (1) pressure exerted from the drilling mud; (2) collapse of the hole already drilled; and (3) influx of fluids from the surrounding formation.
- The outermost casing near the top of the well can be up to four feet in diameter, and the innermost string of casing near the bottom of the well can be less than six inches in diameter. The size of the initial and final casing, the types of casing, and the type of cement used are determined by the profile of the well being drilled, including factors such as well depth, temperatures, and well pressures. Once the well is in production, hydrocarbons are extracted through a tubing string that is run down through the middle of the production casing string.

During drilling, the rig crew pumps a fluid, called “drilling mud” or “mud” down the drill pipe and through the drill bit nozzles. Although the fluid is referred to as “mud,” it is actually a complex system comprised of components that are designed in light of, and tailored to, a variety of well conditions. The mud’s primary function is to assist drill crews in maintaining well control. Drilling mud exerts hydrostatic pressure in the drill pipe and annulus (the space between the drill pipe and the walls of the casing strings or open hole) that is equal to or greater than the pressures encountered in the wellbore, thereby keeping the well balanced and under control. Drilling mud also cools the drill bit and lifts cuttings to the surface as the mud is circulated during drilling.<sup>15</sup> By closely monitoring well pressure, rig crews maintain the wellbore fluid pressure so that it is equal to or slightly greater than the pressures from the formation. This type of pressure balance is referred to as an “overbalanced” condition. By contrast, a well is in an “underbalanced” condition when the formation pressures exceed the wellbore drilling fluid pressures. Rig crews rely upon a number of indicators to track fluid pressures.<sup>16</sup>

---

<sup>15</sup> Operators routinely rely upon drilling mud suppliers to provide assistance with choosing an appropriate drilling mud. Drilling rig crews include “mudloggers” who monitor drilling mud, wellbore pressures, and other data.

<sup>16</sup> This process of monitoring well pressures is referred to as “measurement while drilling.” Operators also routinely rely upon drilling mud suppliers to provide assistance with choosing an appropriate drilling mud and to provide “mudloggers” on the rig to monitor drilling mud, wellbore pressures, and other data.

Cementing is an important factor in well design and the execution of a safe drilling program. After each casing string is set, cement is pumped down the drill string, out the bottom of the casing and back up into the annular space. The cement reinforces the casing string and seals off the annular space, preventing hydrocarbons from flowing through the space. A properly cemented annular space is said to have achieved “zonal isolation.” Operators often work with contractors that possess specific cementing expertise to develop the optimal type of cement for a particular drilling operation. Cementing companies also can help model different anticipated well conditions to help drilling engineers to design a successful cement job. There are a number of different tests that can be performed to assess the quality of a cement job.

During the drilling process, pockets of oil, natural gas, or water that are encountered in porous layers of the formation can exert pressure into the wellbore that may suddenly force mud back up the wellbore with considerable force – this is commonly referred to as a “kick.” To handle kicks and to maintain well control, drilling crews use various mechanisms, including, under extreme circumstances, activation of the BOP stack and diverters. If a kick overwhelms the control mechanisms, a blowout – the uncontrolled flow of hydrocarbons through the wellbore – can occur.

### *C. Companies Involved in the Macondo Well*

BP and Transocean were the primary companies involved in drilling the Macondo well. BP was the majority owner and designated operator of the lease. BP identified the prospect and designed and planned the well. Transocean was the drilling contractor engaged by BP to drill the Macondo well and provide the *Deepwater Horizon*, a dynamically-positioned, mobile offshore drilling unit (“DP MODU”), as well as the drilling personnel.

- **BP** is a global oil and gas company headquartered in London, England. BP operates in more than 80 countries and is involved in oil and gas exploration, production, and refining, as well as the operation of service stations worldwide. BP holds more than 500 active leases in the Gulf of Mexico, more than any other lessee. From 2005 through 2009, BP was the leading producer of oil and gas in the Gulf of Mexico, producing 559,336,436 barrels of oil and 846,352,047 MCF (thousand cubic feet) of gas during that period.

- **Transocean** is the world's largest offshore drilling contractor. Based in Switzerland, Transocean owns more than 140 drilling rigs and operates in the major offshore oil and gas fields in the world. Transocean has grown substantially through a series of corporate acquisitions, including the acquisition of Reading & Bates Falcon (R&B Falcon) in 2000 and Global Santa Fe in 2007. Transocean owned the *Deepwater Horizon* rig, which was under a long-term lease to BP at the time of the Macondo blowout. The lease agreement required Transocean to manage and operate the *Deepwater Horizon* on behalf of BP.

Offshore drilling operations are complex and normally involve the work of many different specialists. In addition to BP, the leaseholder and the designated operator of the Macondo well, and Transocean, the following companies also had significant roles in the operation:

- **Halliburton**, which provides products and services to the energy industry worldwide and is one of the world's largest cementing contractors to the oil and gas industry, provided cement planning, products, and services at Macondo.
- **Anadarko E&P Company LP, Anadarko Petroleum Corporation and MOEX** were BP's partners in the Macondo well. Anadarko E&P Company LP owned 22.5%, and Anadarko Petroleum Corporation owned 2.5%.<sup>17</sup> Both Anadarko companies are U.S. oil and gas exploration companies.<sup>18</sup> MOEX Offshore 2007, a Japanese oil exploration firm, owned a 10% share of the well.<sup>19</sup> The companies shared in BP's costs to drill the Macondo well and would have shared in any profits from the well.
- **Cameron**, which is a Texas-based manufacturer of oil and gas pressure control equipment, manufactured the *Deepwater Horizon's* BOP stack.
- **MI-SWACO**, which provides drilling supplies and services worldwide, developed the mud program and provided drilling mud and personnel to operate the *Deepwater Horizon* rig's mud system.

---

<sup>17</sup> BP-HZN-MBI-00192559.

<sup>18</sup> BP-HZN-MBI-00177777.

<sup>19</sup> *Id.*

- **Schlumberger**, which provides oil field services throughout the world, provided well logging services for the Macondo well.
- **Sperry Drilling (Sperry-Sun)**, a subsidiary of Halliburton that provides drilling data systems and personnel to the drilling industry, equipped the *Deepwater Horizon* with Sperry data sensors and Sperry mudloggers to monitor and evaluate well condition data. The *Deepwater Horizon* was also outfitted with Transocean paddle flow meters to monitor flow.
- **Weatherford**, which provides a variety of drilling services and components, provided the casing, casing centralizers, and float conversion equipment used on the *Deepwater Horizon*.

#### D. *The Deepwater Horizon*

The *Deepwater Horizon* was a deepwater, column-stabilized, semi-submersible DP MODU, designed to drill subsea wells for oil and gas exploration and development. The *Deepwater Horizon* was built for R&B Falcon (which later became part of Transocean) by Hyundai Heavy Industries in Ulsan, South Korea. Construction started in December 1998, and the rig was delivered on February 23, 2001, after Transocean acquired R&B Falcon. At the time of the blowout, the *Deepwater Horizon* was registered in Majuro, Marshall Islands, and leased to BP.

The *Deepwater Horizon's* day rate at the time of the blowout was \$533,495 and the rig's total estimated daily operating costs were approximately \$1 million.<sup>20</sup> As is common in the industry, under its contract with BP, Transocean was allowed a specific amount of time (in this case, up to twenty-four hours per calendar month) for mechanical downtime to perform maintenance and repairs with a maximum accumulation of 12 days of downtime per year.<sup>21</sup> Transocean was not paid its day rate if the rig was not operational due to equipment repairs for time periods beyond this allotment.<sup>22</sup>

---

<sup>20</sup> TRN-USCG\_MMS-00040941.

<sup>21</sup> TRN-USCG\_MMS-00040482.

<sup>22</sup> *Id.*

### E. *The Macondo Well*

BP acquired Lease OCS-G 32306 in an MMS Central Gulf of Mexico lease sale on March 19, 2008. This lease covers 5,760 acres and extends for 10 years, beginning on June 1, 2008. BP is the designated lease operator and shares ownership of the lease with Anadarko and MOEX.

The Macondo well is located approximately 48 miles from the nearest shoreline, 114 miles from the shipping supply point of Port Fourchon, Louisiana, and 154 miles from the Houma, Louisiana helicopter base. BP began drilling the Macondo well (referred to as “spudding” the well) on October 7, 2009, using Transocean’s *Marianas* rig. After the *Marianas* sustained damage during Hurricane Ida in November 2009, BP moved the *Deepwater Horizon* to the Macondo well. The *Deepwater Horizon* crew resumed drilling operations at Macondo in February 2010.

BP and Transocean experienced several challenges in drilling the Macondo well. In October 2009, the well experienced a kick during drilling operations.<sup>23</sup> The drilling crew experienced another kick on March 8, 2010. As a result of the March 8 kick, the drill pipe became stuck in the wellbore, and the rig crew could not pull the pipe free.<sup>24</sup> The crew, therefore, had to sever the drill pipe and drill a bypass around the portion of the well with the stuck pipe.<sup>25</sup> The well also experienced several “lost return” incidents during drilling, when drilling mud pumped down the wellbore did not return to the surface as expected because some volume of the mud flowed into and was lost in the formation.<sup>26</sup> Lost returns are not uncommon and can occur for a variety of reasons, such as a fracture in the formation or drilling in overbalanced conditions.<sup>27</sup> Because of these and other challenges, on April 20, 2010, the Macondo well was about 38 days behind schedule and approximately \$58 million over the original budget.<sup>28</sup>

---

<sup>23</sup> MC 252 Well Activity Report, 10/25/2009.

<sup>24</sup> IADC Reports, 3/8/10 - 3/12/10.

<sup>25</sup> A bypass is a secondary wellbore drilled away from the original hole. It is not uncommon for an operator to drill a bypass while experiencing problems during the drilling of a well.

<sup>26</sup> IADC Reports, 3/8/10 - 3/12/10.

<sup>27</sup> As discussed throughout the Report, the lost returns at the Macondo well were of note because of their frequency and because they occurred along with other anomalies.

<sup>28</sup> BP-HZN-MBI-00125958; BP-HZN-MBI-0019553; BP-MB-HZN-00192599.



Despite these problems, by April 14, the *Deepwater Horizon* crew successfully drilled to the M “56” sand, one of the hydrocarbon-bearing zones that BP geologists and engineers had targeted for the well.<sup>29</sup> Although the original well plan was to drill approximately 1,800 additional feet, the BP drilling team in Houston opted to stop drilling the well at a total depth of 18,360 feet because BP believed the well had reached the base of the target reservoir and that it had run out of drilling margin.<sup>30</sup> In other words, BP concluded that it could no longer safely drill into the formation without creating an underbalanced well (if the mud was too light) or risking fracturing the formation and threatening well integrity (if the mud was too heavy). BP planned to run production casing and temporarily abandon Macondo by sealing it with a surface cement plug so that another rig could return to the well later and take the steps necessary to complete the well for production.

On April 19, the *Deepwater Horizon* crew ran the production casing string into the well.<sup>31</sup> BP’s engineering team had engaged in significant debate over the appropriate design of the casing to run in the final well section. There was additional debate among BP personnel about the number of centralizers, which are pieces of equipment used to keep the casing centered in the well, to use on the final casing string. The crew pumped cement into the annulus and into the shoe track, the section of the casing between the bottom of the well and the float valve installed in the well (a large valve designed to allow fluids to flow down the well while preventing fluids from flowing back up the wellbore during cementing operations).

The purpose of the cement job was to establish an isolation barrier across the hydrocarbon zone at the bottom of the well so that hydrocarbons could not enter the well. In the late hours of April 19 and into the morning of April 20, the rig crew and BP’s cement contractor, Halliburton, pumped cement into the Macondo well to isolate the hydrocarbon zones.<sup>32</sup> Based on data provided by BP, Halliburton designed the cement slurry, which is a mixture of cement, water and

---

<sup>29</sup> BP-HZN-MBI-00126338.

<sup>30</sup> *Id.* As discussed in detail later in this Report, drilling margin is the difference between the weight of the mud used to drill relative to the pore pressures and the fracture gradient of the formation. Common industry practice is to use a drilling margin of 0.5 ppg mud weight under the fracture gradient.

<sup>31</sup> IADC Report 4/19/10.

<sup>32</sup> Halliburton Post Job Cement Report, BP-HZN-CEC011406.

assorted dry and liquid additives.<sup>33</sup> After BP approved the design, Halliburton began pumping the cement.

In addition to cementing, the process of preparing a well for temporary abandonment includes further procedures to secure the well so that the rig's BOP stack and riser can be removed as the rig prepares to move off the location. BP engineers in Houston developed temporary abandonment procedures (different from the MMS-approved procedure) for the Macondo well that included the following steps: performing a positive pressure test;<sup>34</sup> displacing mud in the well from 8,367 feet to the wellhead; performing a negative pressure test;<sup>35</sup> setting a 300-foot cement plug in the well approximately 3,300 feet below the sea floor and setting a lock-down sleeve to lock the final casing into place.<sup>36</sup> BP engineers changed the order of these steps several times in the days before the temporary abandonment.

During all well activities, including temporary abandonment, crew members monitor various sensors on the rig that show fluid volumes and well pressures.<sup>37</sup> These sensors provide real time data to the crew, which monitors and analyzes the data on electronic displays to identify potential kicks, among other things. Early kick detection is critical to maintaining well control.

On April 20, the crew conducted tests to evaluate the integrity of the production casing cement job. The tests were based on MMS-approved procedures that a BP drilling engineer had sent to the rig that morning.<sup>38</sup> The crew first conducted a positive pressure test to evaluate whether the well casing could sustain pressure exerted on it from the inside of the well and received favorable results.<sup>39</sup> On the same afternoon, the crew circulated mud up from the

---

<sup>33</sup> Additives are used to tailor the cement to the needs of a well. For example, a weighting material might be added to a cement slurry when a higher density cement is needed.

<sup>34</sup> A positive pressure test is conducted by pumping fluid into the well after sealing the blind shear rams. The rig crew monitors the well to determine whether pressures in the well remain static.

<sup>35</sup> A negative pressure test seeks to create conditions that simulate what will occur when the well is abandoned. The rig crew displaces drilling mud with other fluids, resulting in the wellbore being underbalanced against the formation pressures. The rig crew then monitors pressures and flow to determine the integrity of the barrier being tested.

<sup>36</sup> BP-HZN-MBI-00129108. Each of these steps is discussed in detail in Section I of the findings and conclusions in this Report.

<sup>37</sup> Fluid includes any fluid (mud, spacer, seawater) coming out of the well or across the rig.

<sup>38</sup> BP -HZN-MBI-00021237.

<sup>39</sup> BP-HZN-MBI-00136947.

well, and pumped the recovered mud onto the *Damon Bankston*, a vessel working alongside the *Deepwater Horizon* at Macondo. Because of the movement of the mud, it was difficult for the crew to track fluid volumes in the wellbore and in the mud pits on the rig.<sup>40</sup>

Next, crew members turned to conducting negative pressure tests on the well, which would give the crew information about whether the production casing cement job was capable of keeping hydrocarbons out of the wellbore. The crew ran two separate negative tests using different procedures for each test. Just prior to 8:00 p.m. on April 20, the BP well site leader on duty on the rig, Donald Vidrine, and Transocean crew members concluded that the second negative test showed that the final cement job was successful.<sup>41</sup> Vidrine also called Mark Hafle, a BP engineer in Houston, around 8:50 p.m. to discuss the surface plug. During this call, Vidrine described the results of the negative tests. Hafle questioned Vidrine about the results of the negative test, but he chose not to investigate further by accessing and reviewing the available real-time data. Instead, Hafle chose to rely upon Vidrine's assurance that the rig crew had successfully performed a negative test.<sup>42</sup>

During the evening of April 20, the *Deepwater Horizon* crew continued with the temporary abandonment procedure by opening the BOP and pumping seawater down the drill pipe to displace mud and a spacer from the riser.<sup>43</sup> During these well activities, the well experienced significant changes in pressure. Personnel responsible for monitoring the condition of the well, however, did not recognize these changes as signs of a kick. The crew members shut down the well around 9:15 p.m. to perform a sheen test on the spacer that they planned to send overboard as it was displaced from the well.<sup>44</sup> The decision to send the displaced spacer overboard rendered Sperry Sun personnel unable to measure returns on one of the rig's flow meters. Due to the placement of the flow meters,

---

<sup>40</sup> BP-HZN-MBI-00021238.

<sup>41</sup> Testimony of Jimmy Harrell, Joint Investigation Hearing, May 27, 2010, at 90-91; Testimony of Miles Ezell, Joint Investigation Hearing, May 28, 2010, at 279-282.

<sup>42</sup> BP-HZN-BLY00125470.

<sup>43</sup> "Spacer" refers to material that rig crews pump into a well to separate the drilling mud from seawater. Displacement of mud and spacer are part of the temporary abandonment procedures discussed in detail in Section IV of the findings and conclusions.

<sup>44</sup> Sperry-Sun rig data, April 20, 2010. The crew performed a sheen test to confirm that all of the oil-based mud had been displaced from the riser. A "sheen test" is intended to indicate the presence of free oil when drilling fluid, drilled cuttings, deck drainage, well treatment fluids, completion and workover fluids, produced water or sand or excess cement slurry are discharged into offshore waters.

the Sperry Sun crew could only measure returns sent to the mud pits and could not measure flow volumes sent overboard.<sup>45</sup>

### F. *The Blowout*

On April 20, 2010, at around 9:40 p.m., powerful pressures from the well caused mud to flow up from the well. Mud spilled on the rig floor as the well began to blowout. The crew responded to the situation by diverting the flow to the mud gas separator, part of the diverter system to which the crew could direct fluids coming up from the well.<sup>46</sup> At this time, crew members likely realized that they had lost control of the well and attempted to regain control of the well by activating the BOP stack's upper annular preventer and the upper variable bore ram.<sup>47</sup>

The mud-gas separator, to which the crew had diverted flow from the well, was quickly overwhelmed and failed, causing a gas plume to fill the rig floor. The gas quickly ignited, causing the first explosion on the rig at 9:49 p.m. Approximately ten seconds later, a second larger explosion occurred and the fire onboard the rig spread rapidly. Shortly after the second explosion, the rig lost power and experienced a total blackout.

At approximately 9:56 p.m., the rig's subsea engineer attempted to activate the BOP stack's emergency disconnect system from the BOP panel on the rig's bridge. The emergency disconnect system is designed to activate the BOP stack's blind shear ram and disconnect the rig's lower marine riser package ("LMRP") from the well. The BOP panel apparently indicated that the emergency disconnect system was activated, but the rig remained connected to the well and hydrocarbons continued to flow uncontrolled from the well.<sup>48</sup> About four minutes after the attempt to activate the emergency disconnect system, personnel on the *Deepwater Horizon's* bridge manually sounded the general alarm and made a muster call for personnel to gather at designated

---

<sup>45</sup> Testimony of Joseph Keith, Joint Investigation Hearing, December 7, 2010, at 135.

<sup>46</sup> The mud gas separator, and the rig crew's decision to use it to handle the influx of hydrocarbons from the well, is discussed in detail in Section V-D of the findings and conclusions.

<sup>47</sup> DNV, *Forensic Examination of Deepwater Horizon Blowout Preventer*, March 20, 2001, (DNV Report) at 4. As discussed in later in this Report, the upper annular preventer and the upper variable bore ram are two BOP stack components that are used by rig crews in well control events. Neither component, however, is designed to shear the drill pipe and completely seal the well – the blind shear ram on the BOP stack is designed to perform these functions.

<sup>48</sup> Testimony of Chris Pleasant, Joint Investigation Hearing, May 28, 2010, at 123.

lifeboat stations. Personnel, including crew members, contractors and visiting executives from BP and Transocean, evacuated the rig on two lifeboats and a life raft. At least six people jumped from the rig into the water.

At 10:00 p.m., the *Damon Bankston*, which prior to the explosions had been directed by the *Deepwater Horizon* to move 500 meters away from the rig, received distress calls from the *Deepwater Horizon* and prepared its fast recovery craft for launch and rescue of those who had abandoned the rig. The *Damon Bankston* retrieved six people from the water and recovered another 108 people from the two lifeboats and life raft. Uncontrollable fires continued to blaze on the *Deepwater Horizon*, and the rig sank on the morning of April 22.

Eleven men died as a result of the blowout and sixteen others were injured. Estimates are that the Macondo well spilled close to five million barrels of oil into the Gulf of Mexico during 87 days between the blowout and when the well was successfully capped on July 15, 2010. After months of additional intervention work, the well was permanently sealed on September 19, 2010.

## II. Well Design

Well design is a fundamental and important phase of offshore drilling operations. Operators must consider site-specific factors, including flows, pressurized formation flows, reservoir natural gas and oil type, reservoir lithology (formation characteristics), reservoir structure, and the anticipated volume of hydrocarbons to determine the best way to drill to the target reservoir and to configure casing to allow production from the well. During the design process, engineers use all available data to determine planned total depth (sometimes referred to as “TD”) of the well, casing point selections, required casing specifications, casing pressure ratings, cement slurry design, mud weight, and risk factors particular to the well.<sup>49</sup>

Development wells are typically designed and drilled based in part on data from nearby wells, referred to as offset well data. In the case of exploratory wells, such as Macondo, operators have limited offset well data available, making it more difficult to anticipate well conditions prior to the spud of the well. As a result, design processes in exploratory wells are subject to change. Operators typically deal with well design changes during drilling operations through documented “management of change” processes, which are intended to aid personnel in systematically identifying and mitigating the risks associated with the changes.

The BP well engineering team and the BP subsurface team were involved in developing the Macondo well design. The teams referred to various documents and manuals while designing the Macondo well, including BP’s internal casing design manual, drilling well operations policy (“DWOP”), advanced guidelines for deepwater drilling and other guidance.<sup>50</sup>

### A. *Cost of the Macondo Well*

BP exceeded its original cost estimates for drilling the Macondo well. To obtain additional funds and continued participation from its partners in the Macondo project, BP submitted to Anadarko E&P Company LP and Anadarko Petroleum Corporation (collectively “Anadarko”) and MOEX several

---

<sup>49</sup> Casing point is the depth at which drilling a particular wellbore diameter will end so that casing of a given size can be run and cemented.

<sup>50</sup> BP-HZN-MBI000010362.

Authorizations for Expenditures (“AFEs”), which included written descriptions of the project and cost estimates for proposed well activities and operations.<sup>51</sup>

Under their operating agreement with BP, Anadarko and MOEX could choose to participate in the activities and operations described in the AFE and thereby commit to the funding necessary to continue the operation; they could propose an alternative operating plan; or they could end their participation in the Macondo project.<sup>52</sup>

BP submitted to Anadarko and MOEX an initial AFE for the Macondo well in August 2009, estimating that the total costs of the well would be about \$96.1 million. Both Anadarko and MOEX approved the operation and expenditures.<sup>53</sup> BP sought its first supplemental AFE for approval of an additional \$27.9 million in January 2010, which the partners accepted in February 2010.<sup>54</sup> In March 2010, BP sought authorization for an additional \$27 million, explaining that it had exceeded the first supplemental AFE due to unexpected lost circulation and well control events.<sup>55</sup> Anadarko and MOEX approved the expenditure and offered no alternative operating plan.<sup>56</sup>

On April 14, after BP had drilled to the Macondo well’s revised target depth, it sought a final AFE for \$3.5 million to fund setting the production casing in connection with the temporary abandonment of the well. Anadarko and MOEX approved the AFE and did not propose any alternative operating plan.<sup>57</sup> In total, the companies allocated \$154.5 million to drilling the Macondo exploratory well, an amount well in excess of the original estimated cost of \$96.16 million and the not-to-exceed cost of \$139.5 million.

Under their operating agreement with BP, Anadarko and MOEX had access to, and in fact reviewed, data and files related to the Macondo well that BP made available to them through shared websites. The Panel found no evidence, other than reviewing this information and approving the AFEs, indicating that

---

<sup>51</sup> BP-HZN-MBI000173275.

<sup>52</sup> BP-HZN-MBI-00173275.

<sup>53</sup> BP-HZN-MBI00192546, BP-HZN-MBI00192549.

<sup>54</sup> BP-HZN-MBI00192552, BP-HZN-MBI00192553.

<sup>55</sup> BP-HZN-MBI00192557.

<sup>56</sup> BP-HZN-MBI00192558.

<sup>57</sup> BP-HZN-MBI00192559, BP-HZN-MBI00192561.

Anadarko or MOEX were directly involved in decisions related to the design or drilling of the Macondo well.<sup>58</sup>

### ***B. Drilling Margin***

Drilling engineers must design a well to manage pore pressure and fracture gradients at different well depths. Pore pressure is the pressure exerted by fluids in the pore space of the formation being drilled. Fracture pressure is the point at which pressure exerted by the drilling fluid in the well would cause the surrounding formation to fracture. The fracture gradient plot, expressed as a calculated equivalent mud weight, is a curve that shows the well's estimated fracture gradient by depth. During well design, engineers typically use a graphical representation of the estimated pore pressure, mud weight, and fracture gradient, which together define the appropriate drilling margins.

Drilling engineers conduct a "leak-off" test to determine the strength or fracture pressure of the open formation. This test is usually conducted immediately after drilling past the cemented casing shoe in the well.<sup>59</sup> During the test, the well is shut in and fluid is pumped into the wellbore to gradually increase the pressure that the formation experiences. At a certain pressure, fluid pumped into the well will enter the formation, or leak-off, by moving through permeable paths in the rock or by creating a space by fracturing the rock. If the pressure is increased beyond the formation fracture point, fracturing of the formation can occur. The results of the leak-off test dictate the maximum pressure or mud weight that may be applied to the well during drilling operations before the formation can be expected to take fluid.

BOEMRE regulations require that "[w]hile drilling, you must maintain the safe drilling margin identified in the approved APD [Application for Permit to Drill]. When you cannot maintain this safe drilling margin, you must suspend drilling operations and remedy the situation."<sup>60</sup> Safe drilling margin can be maintained by ensuring that the mud weight remains between the "kick tolerance" or "kick margin," which is typically 0.5 pounds per gallon ("ppg")

---

<sup>58</sup> Data obtained from Halliburton showed that representatives of Anadarko and MOEX periodically reviewed information related to the Macondo well during drilling.

<sup>59</sup> The "casing shoe" is a short steel collar that is typically attached to the bottom of the casing string. It helps to establish proper positioning of the casing string in the wellbore.

<sup>60</sup> 30 CFR § 250.427(b). BOEMRE regulations do not specify what a "safe drilling margin" is. There may be instances where a safe drilling margin can be maintained outside the "kick" or "swab" margins.



below the fracture gradient, and the “swab” margin, which is typically 0.2 ppg above the pore pressure. In short, the mud must be heavy enough to control the pore pressure and ensure that the formation fluids (including hydrocarbons) do not enter the wellbore, while not so heavy that it fractures the formation.<sup>61</sup>

BOEMRE regulations require operators to provide various data to the Agency demonstrating that the operator is maintaining a safe margin. For example, operators must show, in a single graphic plot, pore pressures, mud weights and fracture gradients for the full extent of the well.<sup>62</sup> The plotted data reflects forecasted data based on 3D seismic and offset well data.<sup>63</sup> When operators encounter unexpected pressures that differ from their forecasts, applicable regulations require the operator to revise its casing design and apply to the Agency for approval of the modification.<sup>64</sup>

The final estimated Macondo well pore pressure, mud weight, and fracture gradient plot submitted to MMS on March 26 is shown at Figure 1. The vertical axis of Figure 1 shows the depth of the well. The horizontal axis shows the mud weight. The red line depicts BP’s planned mud weight, which was designed to be between the kick margin and the swab margin identified in Figure 1.

---

<sup>61</sup> Maintaining mud weight in this range is an industry-accepted practice but is not specifically required by BOEMRE regulations.

<sup>62</sup> 30 CFR §§ 250.413 and 414.

<sup>63</sup> “Off-set well data” are data obtained from wells that are drilled in an area close to the target well.

<sup>64</sup> 30 CFR § 250.427(b).

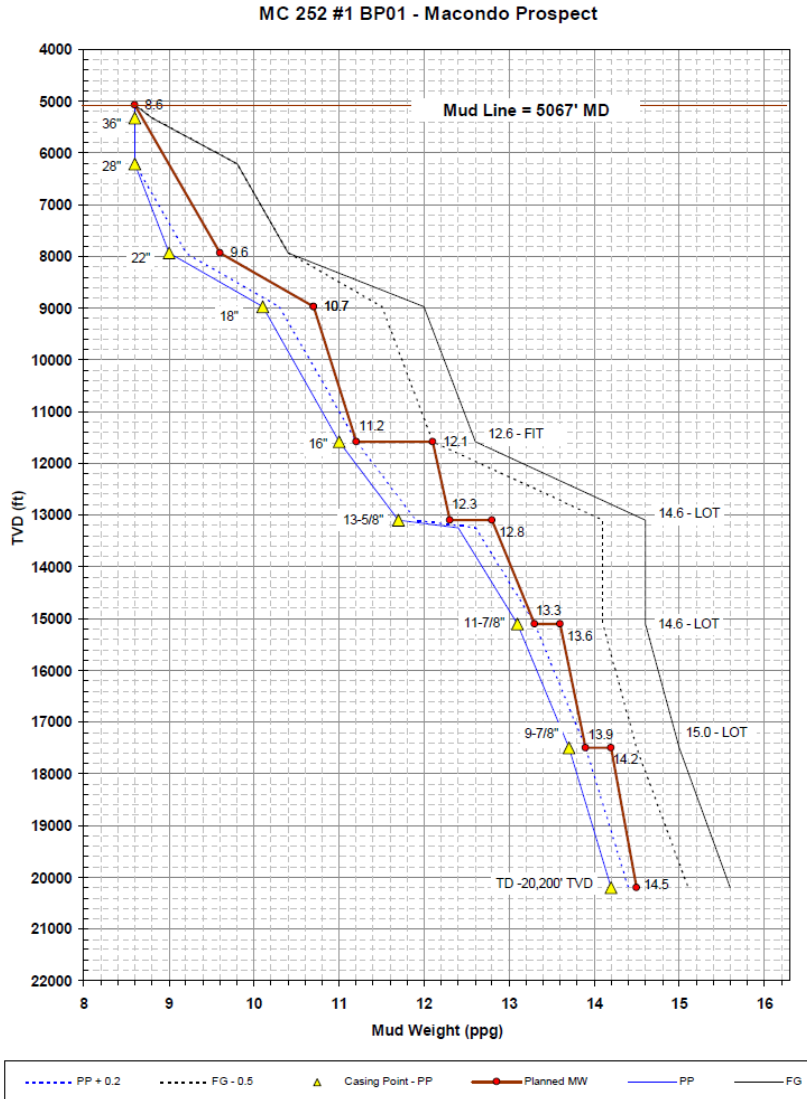

Figure 1 – Macondo Well Pore Pressure Fracture Gradient Plot<sup>65</sup>

As seen in Figure 2, the formation integrity test at the 9-7/8 inch liner shoe located at 17,168 feet yielded results of 15.98 ppg (as identified in the IADC daily reports, which are completed by the rig crew to document daily operations) and 16.22 ppg (identified in BP's Daily Operation Report). The Panel found that this integrity test may have created uncertainty because (1) it was 1.0 ppg higher than anticipated and (2) there was a possibility that the test results did not reflect a true test of the formation below the 9-7/8 inch liner shoe. Although this fracture gradient test was questionable, BP chose not to retest the fracture gradient at the shoe and decided to drill ahead. After drilling the M57C sand interval, BP

<sup>65</sup> API 608174116901, March 26 APD (Revised Bypass) for the Macondo Well.

conducted a Geotap survey to determine the sand pore pressure. The sand pore pressure was determined to be 14.15 ppg. BP also converted this pore pressure to an estimated fracture gradient of 15.0 ppg. The open-hole section drilled utilized a surface mud weight range of 14.1–14.5 ppg, which allowed for a safe drilling margin to be maintained between pore pressure and fracture gradient. Throughout this interval, however, BP encountered multiple problems associated with both lost returns and regressing pore pressures (1.9 ppg difference) between 17,001 and 18,066 feet. BP lost approximately 4,000 barrels (“bbls”) of mud in the production open-hole interval. BP utilized loss circulation material in this interval to attempt to control these losses.

| Open Hole Interval below 9 7/8-in Liner @ 17,168 - FIT 15.98 PP 13.9 |                 |      |              |                |                                |                                |
|--|-----------------|------|--------------|----------------|--------------------------------|--------------------------------|
| Date   | Depth           | MW   | Losses       | PP             | Remarks                        | Hydrocarbon Zones              |
| 2-Apr  | 17,007 - 17,321 | 14.3 |              |                | 17,168 FIT 16.22 PPG           | 17,684 - 17,693 M-57C 14.1 PPG |
| 3-Apr  | 17,321 - 17,835 | 14.5 | 233 bbls     |                | 17,723 - GeoTap 14.15 ppg (PP) | 17,786 - 17,791 M-56A 13.1 PPG |
| 3-Apr  | 17,835 - 17,909 | 14.3 |              |                |                                |                                |
| 4-Apr  | 17,909 - 18,195 | 14.3 |              | 12.58 @ 18,089 | Schematic - 12.6 ppg at 18,066 | 18,061 - 18,223 M-56E 12.6 PPG |
| 4-Apr  | 18,215 - 18,250 | 14.4 | 639 bbls     |                | Lost full returns              |                                |
| 5-Apr  | 18,260          | 14.0 | 1263 - Total |                |                                |                                |
| 6-Apr  |                 | 14.0 | 1586 - Total |                |                                |                                |
| 7-Apr  |                 | 14.0 |              |                |                                |                                |
| 8-Apr  |                 | 14.0 |              |                |                                |                                |
| 9-Apr  | 18,360          | 14.0 |              |                | called TD                      |                                |

Figure 2 - Drilling margin data from IADC reports and BP Daily Reports

BP continued drilling until it concluded it had run out of drilling margin between mud weight and formation pore pressure. Robert Bodek, BP Geological Operations Coordinator, emailed Michael Bierne, another BP employee, on April 13, 2010, and explained the reasons why BP concluded that it had run out of drilling margin at 18,360 feet. He said that the team decided to stop drilling because it had become “a well integrity and safety issue.”<sup>66</sup> The email also states:

We had one major problem however: the sand that we took the initial GeoTap pressure in was measured at 14.15 ppg. The absolute minimum surface mud weight we could use to cover the pore-pressure in this sand was 14.0 ppg. This would give us approximately a 14.2 ppg ESD over the aforementioned sand. If we were to drill ahead with a 14.0 surface mud weight/14.2 ESD, our equivalent circulating density (ECD) would be approximately 14.4-14.5 ppg. We had already experienced static losses with a 14.5 ppg ESD! It appeared as if we had minimal, if any, drilling margin . . . Drilling ahead any further would unnecessarily jeopardize the wellbore. Having a 14.15 ppg exposed sand, and taking losses in a 12.6

<sup>66</sup> BP-HZN-MBI00126338.

ppg reservoir in the same hole-section had forced our hand. We had simply run out of drilling margin.

### *C. Casing Program*

Casing programs describe the number and sizes of the casing strings to be set in the wellbore and are based upon pore pressure and fracture gradient plots. Casing programs are designed based on a number of factors, including burst and collapse pressures,<sup>67</sup> tensile strength,<sup>68</sup> drill bit size, anticipated hydrocarbon flow, and hydrocarbon type. BP originally designed the Macondo well to include seven casing strings to reach the target well depth. However, based on the actual conditions encountered during drilling, BP used nine casing strings to reach total depth.

Conditions encountered during drilling can drive changes in casing programs. For example, circulation loss events occurred in the open-hole section of the Macondo well. Lost circulation is the loss of drilling fluids (such as drilling mud and spacer) into the formation. This loss of drilling fluid is observed during the circulation of drilling fluids. When less fluid is returned up the well annulus than was pumped into the well through the drill string, this means a loss of drilling fluid – lost returns – has occurred. These lost returns were a factor in BP's decision to limit the well total depth to 18,360 feet (short of the 20,200 feet originally planned) and also led BP to revise the well's casing design program to account for mud weight and fracture gradient drilling margin issues. Specifically, BP modified its casing program several times because of: (1) a well control event in March 2010 that resulted in the drill pipe becoming stuck; (2) changes in pore pressure estimates; and (3) well ballooning.<sup>69</sup> After BP revised its casing program, it submitted a revised Application for Permit to Drill to MMS for approval.<sup>70</sup>

---

<sup>67</sup> Burst pressure is the theoretical internal pressure differential at which a joint of casing will fail. Collapse pressure is the pressure at which a tube or vessel will catastrophically deform as a result of differential pressure between the outside and the inside of the tube or vessel. Schlumberger Oilfield Glossary.

<sup>68</sup> Tensile strength is the force per unit cross-sectional area required to pull a substance apart. Schlumberger Oilfield Glossary.

<sup>69</sup> Ballooning, in which the formation absorbs drilling mud while the rig's pumps are activated and then releases the mud back into the well when the pumps are not active, can be misinterpreted as a kick.

<sup>70</sup> MMS approved: BP's Application for Permit to Bypass, which added an additional casing string, on March 15, 2010; BP's Revised Application for Permit to Bypass, which added a liner, on

#### *D. Mud Program and Type*

Drilling mud provides hydrostatic pressure - pressure exerted by a fluid at equilibrium due to the force of gravity - to prevent formation fluids from entering the wellbore. Drilling mud also keeps the drill bit cool and clean during drilling, carries drilled cuttings out of the well and suspends the drill cuttings whenever drilling is paused.

Operators have multiple options for the type of mud to use during the drilling of a well, including oil-based mud, synthetic oil-based mud and water-based mud. Depending on reservoir conditions, operators assess which mud type is most appropriate for the specific well being drilled.

For the Macondo well, BP chose a synthetic oil-based invert mud system, a system in which synthetic oil in the mud remains in a continuous fluid phase in the lower hole sections of the well. BP chose this system for several reasons: (1) to enhance the ability to maintain consistent fluid properties independent of the temperature and pressure conditions of the well; (2) to improve hole cleaning and minimize barite sag, control of pressure spikes, and gaining gel strengths;<sup>71</sup> and (3) to deal with other problems that result when balancing equivalent circulating density (“ECD”).<sup>72</sup> In selecting the synthetic oil-based mud, BP also sought to reduce fluid loss in order to minimize formation damage while maintaining a higher drilling efficiency.

Synthetic oil-based mud, such as the type BP used in the Macondo well, has many positive features as described above. However, this type of mud also presents risks relating to its effect on the crew’s ability to accurately detect natural gas influx (kicks) into the well. A recent study of drilling fluid mixtures and well control found that drillers might have a harder time detecting kicks

---

March 26, 2010; and BP’s Revised Application for Permit to Bypass, which included a production casing, on April 15, 2010.

<sup>71</sup> Society of Professional Engineers, SPE-116013-PA - *Study of the PVT Properties of Gas—Synthetic-Drilling-Fluid Mixtures Applied to Well Control* (2009). “Barite sag” is the settling of barite particles (or other weighting materials), which can result in fluctuations in drilling fluid density. When this occurs in drilling mud, the mud loses its integrity and can only be a temporary barrier in the well. Gaining, or progressive, gel strengths typically require higher pump pressures to break circulation.

<sup>72</sup> ECD is the total effective pressure that a column of drilling mud exerts on a formation as the mud is circulated through the drill string and back up the wellbore, accounting for frictional forces throughout the circulatory system.

when using synthetic oil-based mud. The study stated that “an important aspect that should be addressed when drilling with a synthetic fluid is the peculiarities concerned with well control. Because of the solubility of formation gas in oil-based fluids, it could be completely dissolved in the mud at bottom-hole temperature and pressure conditions, making kick detection very difficult.”<sup>73</sup>

The Panel found no evidence that BP and MI-SWACO discussed whether the use of synthetic oil-based mud would affect the rig crew’s ability to detect kicks during drilling operations at Macondo. Even so, the Panel found no evidence that the specific mud program used by BP and MI-SWACO was a cause of the blowout.

### *E. Mud Losses*

Throughout the drilling of the Macondo well, BP experienced multiple incidents where mud was lost into the formation. While the loss of mud during drilling operations is not uncommon, it is a key indicator to drilling engineers that they must monitor the well closely to ensure that well and formation integrity are being maintained properly. Abnormal pressure zones identified as a result of mud loss events often lead drilling engineers to change the well design and casing setting points.

BP drilled the Macondo well to a measured depth of 18,360 feet. The crew set a 9-7/8 inch liner in place at 17,168 feet measured depth prior to drilling the production section, which was the final section of the well. The last section was difficult to drill due to a decrease in the fracture gradient at the bottom of the wellbore. This condition required BP to carefully select the correct mud weight necessary to maintain overbalance relative to the formation while avoiding fluid losses to the well.

According to IADC daily reports, the well experienced mud losses of approximately 3,000 bbls across the hydrocarbon zones of interest during the drilling of the production casing open-hole section. The crew controlled these losses with the addition of lost circulation material (“LCM”) pills and a relatively small quantity (less than 200 bbls) of a special blend of drilling fluid, which help retard the loss of mud into fractures and highly permeable formations. From the time the *Deepwater Horizon* moved onto location at Macondo, a total of

---

<sup>73</sup> *Id.*

approximately 15,500 bbls of drilling fluids were lost during drilling, running casing and cementing operations.<sup>74</sup>

#### *F. Well Ballooning*

Well ballooning is a common phenomenon in which the formation absorbs drilling mud while the rig's pumps are activated and then releases the mud back into the well when the pumps are not active. Well ballooning is significant because it can mimic a kick. Rig crews can therefore miss critical kick indicators if they mistakenly believe that ballooning is occurring in the well.

Mud logging data for the Macondo well demonstrated that the production casing zone started ballooning between 17,530 feet and 17,761 feet. The daily IADC reports also show that the well flowed back during flow checks following mud loss at those depths.

#### *G. Planned and Actual Total Depth*

In designing a well, engineers calculate a planned total depth of the well. BP's February 2009 Exploration Plan estimated the well depth at approximately 20,200 feet true vertical depth. Due to a narrowed drilling margin, BP ultimately decided to stop drilling the well at 18,360 feet.

BP set a casing string at 17,168 feet measured depth (sometimes referred to as "MD") and then continued to drill the final production section of the well. In the section below the last two casing strings, the well lost returns, indicating possible fracturing or formation pressure regression. In response, the crew stopped drilling, pumped in lost circulation materials to seal the fracture, and restored mud circulation.<sup>75</sup> In this open-hole interval (where no casing string had been set yet) the pore pressure decreased from 14.5 ppg to 12.6 ppg between the sand interval at 17,233 feet measured depth and the M56 target formation at 18,083 feet through 18,206 feet. Because of the decreasing pore pressure at this depth of the well, there was no drilling margin in the open-hole section of the well, which meant that the mud weight necessary to prevent the formation from flowing at the upper portion of the open hole could result in the formation fracturing in the lower section.<sup>76</sup> BP explained to its partners, MOEX and

---

<sup>74</sup> BP-HZN-MBI00304121.

<sup>75</sup> BP-HZN-MBI00126338.

<sup>76</sup> *Id.*

Anadarko, that it chose to terminate the well at 18,360 feet MD, based on concerns about well integrity and safety related to this loss of drilling margin.<sup>77</sup>

By terminating the well where it did, BP set the total depth of the well in a laminated sand-shale interface.<sup>78</sup> BP internal guidelines for total well depth specify that drilling should not be stopped in a hydrocarbon interval, unless necessary due to operational, pressure and safety issues.<sup>79</sup> Typically, total depth is not called in a sand section because placing the casing shoe – the section of the casing between the bottom of the wellbore and the float valve – in a laminated sand-shale zone increases the likelihood of cement channeling or contamination due to washout, and creates difficulties in logging well data.<sup>80</sup> Figure 3 depicts the placement of the Macondo well shoe track.

---

<sup>77</sup> *Id.* BP's September 2009 Pre-Drilling Data Package also indicated that, if after drilling the primary M56 objective there was an onset of pressure requiring a new casing string, no further drilling would be feasible. See BP-HZN-MBI00013494.

<sup>78</sup> Sand is more permeable than shale. Therefore, when casing is set in sand, lost returns are more likely.

<sup>79</sup> BP-HZN-MBI00013494.

<sup>80</sup> Cement channeling occurs when the cement slurry in the annulus does not rise uniformly, leaving spaces and therefore preventing a strong bond.



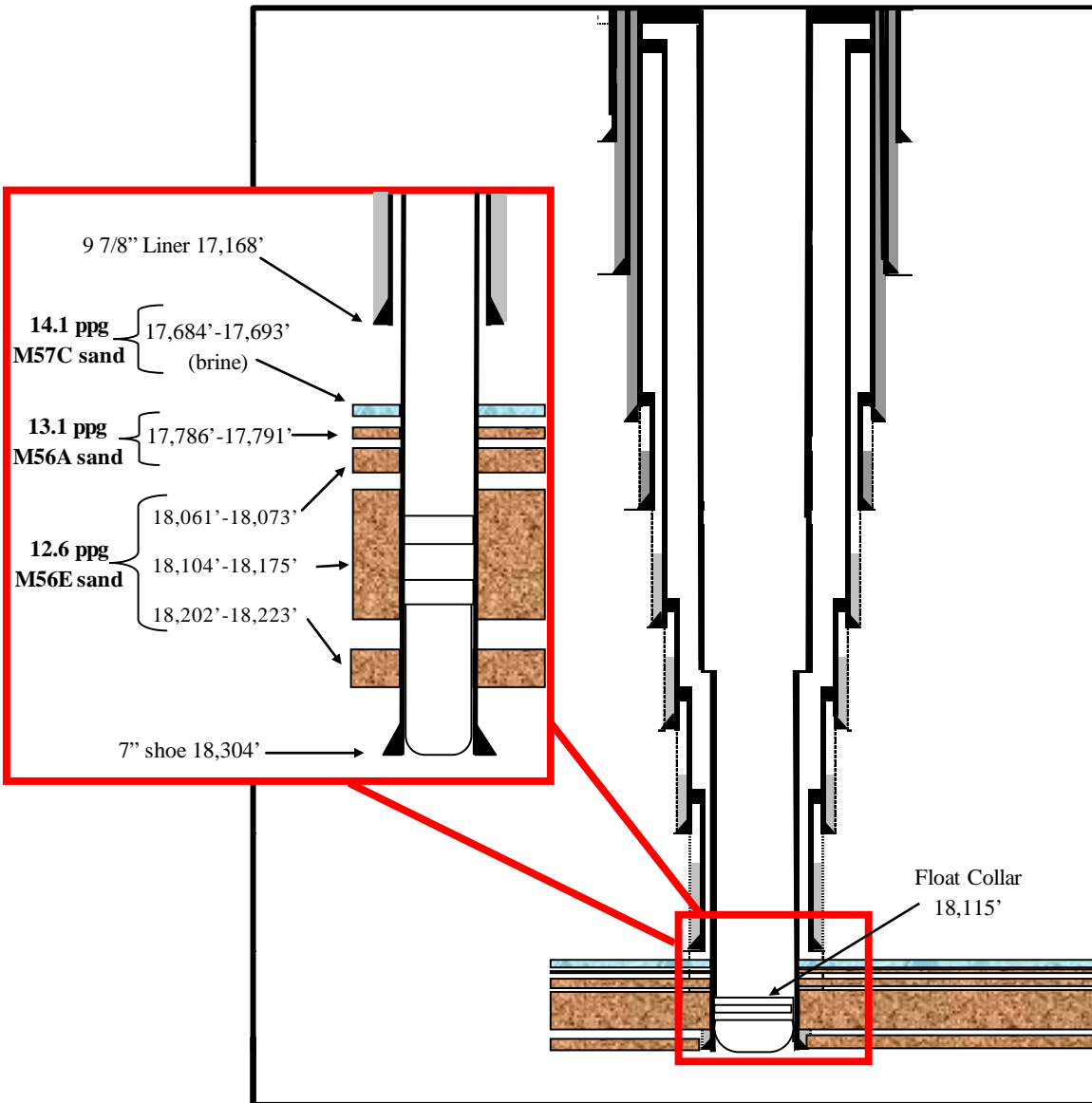

Figure 3 - Macondo Well Shoe Track and Hydrocarbon Intervals

#### H. Designing the Production Casing – Long String versus Liner

BP drilled the Macondo well to a hydrocarbon-bearing zone and planned to return to this zone at a later date to complete the Macondo well for production. Before moving the *Deepwater Horizon* rig off of the Macondo well, BP chose to set a production casing that would be used to extract hydrocarbons at a later date.

The production casing runs from the bottom of the well up to the wellhead. There are two general design options for production casings – a long string design or a liner design. A long string casing design consists of a production casing that extends from the bottom of the well to the top of the wellbore. A liner casing design consists of a casing that is anchored or suspended from inside the bottom of the previous casing string and does not extend to the top of the wellbore. The liner design has the option of being tied back to the top of the wellhead.

In general, both long string and liner production casings have two annulus barriers: cement across the hydrocarbon zones and the mechanical seal at the top of each string. The mechanical seal in a long string casing includes the wellhead casing hanger seal assembly. A liner design uses a liner top packer assembly. The liner tie-back provides two additional barriers: the liner tie-back cement and the tie-back seal assembly. However, the use of a liner tie-back design also involves risks associated with the possibility of mechanical integrity failure at the tie-back junction, as well as the potential for increased annular pressure build-up, which could occur as a result of annular fluid expansion caused by heat transfer during the well's production phase. Annular pressure build-up increases the risk that the production casing or tie-back string will collapse if annulus fluids or pressure become trapped by the assembly with no outlet for bleed-off.

BP's well engineering team prepared an undated "Forward Plan Review" addressing production casing and temporary abandonment options for the Macondo well and circulated it within BP in April 2010. The forward plan recommended against using the long string design because of the risks described above that are associated with that type of design. This document stated that, while the long string of 9-7/8 x 7 inch casing "*was* the primary option," the use of a 7 inch liner was "*now* the recommended option" for the following reasons: cement simulations suggested that cementing the long string was unlikely to be successful due to formation breakdown; using a long string would prevent BP from meeting regulatory requirements of 500 feet of cement above the top hydrocarbon zone; the long string would result in an open annulus to the wellhead, with hydrocarbon zones(s) open to 9-7/8 inch seal assembly as the only barrier; and the potential need to verify the cement job with a bond log and to perform one or more remedial cement jobs prior to the temporary abandonment of the well.<sup>81</sup>

---

<sup>81</sup> BP-HZN-MBI00020910.

BP also identified advantages of using a liner design, including that the liner hanger would act as second barrier for hydrocarbons in the annulus; the primary cement job on the liner had a slightly better chance for successful cement lift due to lower ECD;<sup>82</sup> and it would be easier to justify postponing any remedial cement job until after the temporary abandonment procedure was completed.<sup>83</sup>

BP employees evaluated these approaches to designing the production casing. For example, on April 14, BP Drilling Engineer Brian Morel emailed a colleague, Richard Miller, about the options. In his email, Morel referred to Macondo as a “nightmare well which has everyone all over the place.” Miller responded to Morel’s email, advising Morel that he had updated his calculations and model, which indicated that both proposals for the production casing design were “fine.”<sup>84</sup>

When early cement modeling results suggested that the long string could not be cemented reliably, BP’s design team switched to a liner design. However, on April 13, Morel asked Eric Cunningham, an in-house BP cementing expert, to review Halliburton’s cementing recommendations and modeling. Cunningham determined that certain cement modeling parameters used by Halliburton should be corrected. The results of the revised modeling caused BP to switch back to the use of a long string as the primary option for the production casing.

Ultimately, BP chose to install a long string production casing in the Macondo well instead of using a liner and tieback. A BP “Management of Change” document stated that this decision was based on the following factors: the long string provided the “best economic case and well integrity case for future completions operations;” the recent cement modeling showed that the long string could be cemented successfully and, while use of a liner “is also an acceptable option,” doing so would add \$7-10 million to the cost of completing the well.<sup>85</sup>

The Panel found no evidence that the long string production casing design was a cause of the blowout.

---

<sup>82</sup> Cement lift is increased pump pressure that results when cement that is pumped down the well begins to flow back upward against gravity.

<sup>83</sup> BP-HZN-MBI00020910.

<sup>84</sup> BP-HZN-CEC000021857.

<sup>85</sup> BP-HZN-MBI00143292. “Management of Change” is BP’s formal process for evaluating and approving operational decisions.

BP had a third option (other than installing a long strong production casing or a liner tie-back) – it could have temporarily abandoned the Macondo well without setting any production casing, which is an option for wells with zero drilling margin. For example, in January 2009, on a well BP drilled prior to Macondo, the Kodiak well at MC 727 Number 2, the *Deepwater Horizon* crew temporarily abandoned the well without running production casing. In August 2009, BP and the *Deepwater Horizon* crew also temporarily abandoned the Tiber well, KC 102 Number 1, which had similar drilling margin hazards to the Macondo well, without setting a production casing. BP acknowledged this third option in a later iteration of the temporary abandonment and production casing “Forward Plan” discussed above, which stated that the company could plug the open hole and temporarily abandon the well. BP noted that this was an option if “hole conditions go south.”<sup>86</sup> While all of the “primary well objectives” had been achieved, and although BP could have minimized any additional immediate spending on the well, the third option would have increased completion costs by \$10 to \$15 million because BP would at a future time have had to drill out the cement plugs, re-drill the production hole, and re-log the well data.<sup>87</sup> For these reasons, this was BP’s least preferred option.

If BP had temporarily abandoned the Macondo well without running the production casing, as it had done with prior wells with narrow drilling margins, BP would likely have had an opportunity to consider other options for setting the casing, such as sidetracking the well and setting the casing in a location with a lower potential for lost returns. In addition, as discussed below, if BP had temporarily abandoned the Macondo well without setting a production casing, it would not have taken steps to set a lock down sleeve and could have set the surface plug higher in the well.

---

<sup>86</sup> BP-HZN-MBI00143295.

<sup>87</sup> *Id.*

### III. Cementing

The main purpose of cement within a well is to achieve zonal isolation. Cement reinforces the casing and prevents the flow of hydrocarbons through the annular space. This section discusses the cementing of the final production casing in the Macondo well.

#### A. *Cementing Process*

Prior to cementing a well, the rig crew conditions the wellbore by circulating mud through it. This conditioning cleans out any cuttings or other debris in the casing, drill pipe and wellbore that could interfere with cement placement. When mud is circulated completely through the casing (so that the mud on the bottom of the well returns to the surface), operators have achieved a “complete bottoms-up.” By performing a complete bottoms-up, the crew not only cleans out the wellbore, but can also analyze the mud that had been on the bottom of the well to determine whether hydrocarbons are present before cementing.

After circulating mud, the crew pumps the volume of cement modeled for the job down the well, followed by the drilling mud that is pumped behind the cement to push the cement to its planned location. Darts and wiper plugs separate the cement from the mud to prevent the oil-based mud from mixing with, and possibly contaminating, the cement.<sup>88</sup> At Macondo, the crew first pumped base oil (synthetic oil with no additives) ahead of a water-based spacer (a spacer is a fluid mixture that keeps the mud and cement separated). The spacer was followed by a bottom dart, the cement, the top dart and more spacer. After the second spacer, the crew pumped drilling mud to push the materials in front of it down the drill pipe.

When the darts reach the end of the drill pipe, the darts launch bottom and top wiper plugs that separate the cement from the other materials traveling down the well. When the bottom plug reaches the top of the float collar, pressure causes the plug to rupture, and cement passes through the plug into the shoe track. After all of the cement has moved through the bottom plug and into the track, the top wiper plug lands on the float valves. The top plug is not

---

<sup>88</sup> A “dart” is a device pumped through a tubing string to activate downhole equipment and tools. A “wiper plug” is a plastic component that travels down the well to separate the spacer and the cement.

designed to rupture but instead remains intact to prevent mud or spacer from flowing down the well. If the cement job has gone as planned, the cement should be in the correct place in the annulus and should fill the shoe track when the top plug lands.

## ***B. Cement Design and Modeling***

BP worked with Halliburton to design the parameters of the Macondo cement job. Because of the lost returns BP had encountered throughout the drilling of the Macondo well, BP focused on reducing the chance of additional losses during the final cement job. BP sought to minimize these losses by reducing the volume of cement it pumped into the well, lowering the rate at which cement was pumped into the well and using a nitrified cement slurry for part of the cement job. As discussed further below, use of lower density nitrified foam cement offered advantages in terms of reducing the risk of formation breakdown, but also presented technical challenges in ensuring that the cement mixture is stable.<sup>89</sup>

### *1. Cement Volume*

BP chose to limit the height of the cement in the annulus because the higher the annular cement column, the more pressure the cement would exert on the formation below, increasing the likelihood of additional lost returns and potential for fracturing. BP engineers proposed to set the top of the cement in the annulus at about 17,300 feet total depth, which was approximately 500 feet above the uppermost hydrocarbon zone.<sup>90</sup> MMS regulations required the cemented annular space in a production casing job to be 500 feet above the uppermost hydrocarbon zone.<sup>91</sup>

---

<sup>89</sup> On August 1, 2011, Oilfield Testing and Consulting (“OTC”) completed a forensic analysis of the cement samples mixed to replicate the cement slurries that were pumped into the Macondo well. OTC’s analysis revealed a range of potential cement setting times for the foamed and unfoamed cement. Several of the samples tested revealed setting times greater than 18 hours (the time period between the completion of the cement job and the start of the negative tests). See OTC Report at page 30. The Panel, however, found that there was strong evidence that the cement had set prior to the time the rig crew performed the negative test. See <http://www.oilspillcommission.gov/sites/default/files/documents/Chevron%20letter%2010%2026%2010.pdf>.

<sup>90</sup> BP-HZN-MBI0023746. “Top of cement” is the depth in the well where the cement that has already been set in the well ends.

<sup>91</sup> 30 CFR § 250.421.

Halliburton pumped a total of 51 bbls of cement for the production casing cement job, consisting of 5.26 bbls of lead cement, 38.9 bbls (47.74 bbls when foamed) of foamed cement, and 6.93 bbls of tail cement.<sup>92</sup> BP did not plan to pump cement above the top wiper plug in order to preserve the ability to run a cement evaluation log (discussed below), if necessary. Cement above the wiper plug would have provided an additional barrier to hydrocarbon flow.

## 2. *Pump Time and Rate*

BP planned to pump the cement into the well at a relatively low rate of four barrels a minute in order to reduce pressure on the formation that could result in lost returns. This strategy carried risks since a higher pumping rate generally would have increased the likelihood that cement would displace mud from the annulus and thereby would have increased the likelihood of a successful cement job.

BP was aware that it was using a low pump rate, so it wanted to be able to maximize the amount of time it could run the pump without the cement setting up or fracturing the formation. Brian Morel, BP Drilling Engineer, expressed this in an email to John Guide, BP wells team leader, on April 17, which stated: “I would prefer the extra pump time with the added risk of having issues with the nitrogen. What are your thoughts? There isn’t a compressive strength development yet, so it’s hard to ensure we will get what we need until its [sic] done.”<sup>93</sup>

## 3. *Nitrified Cement*

Another way in which BP sought to reduce additional lost returns during the cement job was by using a nitrified or “foamed” cement slurry in the annular space (the “tail cement” for the shoe track was unfoamed cement). Cement specialists make nitrified or foamed cement by injecting cement with nitrogen bubbles while the cement is being prepared on the rig. Nitrified cement is less dense than unfoamed cement and therefore exerts less pressure on the formation. However, the use of foamed cement creates the risk of nitrogen breakout – if the nitrogen bubbles in the cement “break out” of suspension – which can result in inconsistent cement placement and densities. The use of nitrified cement in

---

<sup>92</sup> BP-HZN-CEC011406.

<sup>93</sup> BP-HZN-MBI00255923.

deepwater wells is typically a viable option; however, care should be taken when designing and executing the job to prevent nitrogen breakout.

Testing the stability of foam cement before it is used in an offshore cement job is common practice in the industry. Consistent with this practice, Halliburton shipped samples of the Macondo cement to its laboratory in advance of the date on which the cement components were to be used on the Macondo well and retained surplus samples from the testing program. Halliburton conducted pre-job testing of the mixture of ingredients to be used in the Macondo cement slurry to assess whether the cement could be pumped and would set up properly under conditions simulated to match those down the wellbore.

While Halliburton conducted several pre-job cement tests, it did not finish its final compressive strength analysis for the cement used on the production casing string. Compressive strength analyses determine the length of time for the cement slurry to develop sufficient strength to achieve zonal isolation and provide sufficient support to the casing. On April 19, Jesse Gagliano, the Halliburton in-house cementing engineer, told the BP well site leaders and Brian Morel that the compressive strength analysis for the cement job had not been completed.<sup>94</sup> Nevertheless, BP continued the cement job without this information. The Panel found no evidence that BP or Halliburton ever shared the cement stability results or the OptiCem reports (showing gas flow potential) with Transocean personnel on the *Deepwater Horizon* or in the Houston office.

Halliburton's post-blowout laboratory worksheets dated May 26, 2010, show that the foam-slurry cement did not meet American Petroleum Institute Recommended Practice ("API RP") 65.<sup>95</sup> Additionally, laboratory tests conducted by Chevron on behalf of the National Commission on the BP Deepwater Horizon Oil Spill and Deepwater Drilling ("Presidential Commission") showed that the foamed cement slurry used on the Macondo well was not stable.

#### 4. *Cementing a Long String*

As discussed above, BP debated internally whether to use a long string or liner with tieback as the final production casing. BP had difficulties with the cement in one of the two long strings it ran in the Macondo well prior to the

---

<sup>94</sup> BP-HZN-MBI00192892.

<sup>95</sup> HAL0050590.



production casing. When BP drilled out the cement job on the 16-inch intermediate long string, it discovered that the condition of the shoe track suggested that the cement had not set up properly, leading the cement to channel and result in lost returns.<sup>96</sup>

## 5. Cement Modeling

Offshore operators use cement models to calculate real-time equivalent circulating densities based on actual cement volumes, rates and fluid densities. By modeling various inputs, operators can assess, among other things, the likelihood that channeling in the cement will occur as it sets up. Channeling in cement is a problem because it can provide an opportunity for gas to flow through the cement, which is quantified as gas flow potential.

For the Macondo well, BP used Halliburton's OptiCem program to model pumping sequences of various fluid densities and volumes to determine whether the minimum formation fracture pressure would be exceeded. In all, Halliburton developed at least 30 to 40 models for the cement to be used with the Macondo production casing.<sup>97</sup> In developing these models, BP and Halliburton frequently changed assumptions about the casing string and number of centralizers to be used. For example, Halliburton generated an OptiCem model on April 15 at 3:30 p.m., which showed that channeling could result if only ten centralizers were installed in the well. The model called for ten centralizers to be installed between 18,300 feet and 17,811 feet measured depth, using approximately 45-foot spacing and an approximate 80% standoff.<sup>98</sup> The resulting gas flow potential ("GFP") was moderate at a reservoir zone of 18,200 feet measured depth.

Later on April 15, Halliburton ran a second model using 21 centralizers installed between 18,300 feet and 17,400 feet measured depth, using 45-foot spacing with a 70% top of centralized interval standoff. This model predicted that channeling would not occur; the resulting gas flow potential was minor. Based on this report, BP ordered 15 additional centralizers to supplement the six centralizers already on the *Deepwater Horizon*. BP's decision-making with respect

---

<sup>96</sup> BP-HZN-MB100036098. Cement channeling is a failure during the cementing of the casing to the formation in which the cement slurry leaves open spaces where hydrocarbons can potentially flow. The shoe track is the space between the float collar and a piece of equipment called a reamer shoe (located at the bottom of the casing).

<sup>97</sup> Testimony of Jesse Gagliano, Joint Investigation Hearing, August 24, 2010, at 245.

<sup>98</sup> Standoff is the smallest distance between the casing and the wellbore wall. The standoff ratio is the ratio of the standoff to the annular clearance for a perfectly centered casing.

to the installation of centralizers during the temporary abandonment procedure is discussed in more detail below.

On April 18, 2010, Halliburton modeled the well with seven centralizers installed between 18,305 feet and 18,035 feet measured depth, with 45-foot spacing. The resulting gas flow potential was severe at a reservoir zone of 18,200 feet measured depth.

At approximately 8:58 p.m. on April 18, Jesse Gagliano, a Halliburton cementing engineer, sent an email to several BP and Halliburton personnel attaching this version of the OptiCem model, along with partial lab results on compressive strength and Halliburton's recommended cementing procedure for the Macondo well cement job.<sup>99</sup>

BP used the April 18 OptiCem report as the basis for the actual cement job it performed on April 19.

#### 6. *Weaknesses in the Cement Modeling*

The Panel identified the following incorrect assumptions in the April 18 OptiCem model:

- The model assumed a pore pressure of 13.97 ppg for the hydrocarbon zone at 18,200 feet based on a linear profile between 17,700 feet and 18,305 feet. This was inconsistent with the measured pore pressure value of this zone, which was 12.5 to 12.6 ppg.
- Halliburton's report used incorrect centralizer data. The model used a nominal diameter of 8.622 inches, but the installed centralizers had an actual diameter of 10.5 inches. The model also spaced the centralizers 45 feet apart instead of using the actual, variable centralizer spacing BP specified to Halliburton.<sup>100</sup> The model also assumed seven centralizers rather than the six that actually were used in the Macondo production casing cement job.

---

<sup>99</sup> BP-HZN-MBI00128708.

<sup>100</sup> BP specified that centralizers would be spaced at varying intervals. See BP-HZN-MBI00127389.

- While Halliburton modeled the mud as an oil-based mud with a constant density of 14.17 ppg, the synthetic oil-based mud actually used in the well was compressible and had a variable density.
- Halliburton's cement job design included using base oil with a density of 6.7 ppg. BP actually used the 6.7 ppg density base oil in the final cement job, but Halliburton's April 18 model assumed that the base oil would have a 6.5 ppg density.
- In the April 18 model, Halliburton assumed 135° F as the bottom hole circulating temperature, but BP modeling showed that circulating temperature during cementing would be 140° F.

The Panel found no evidence that, despite the inconsistencies described above, BP questioned the data in the April 18 model before the blowout. Nor did the Panel find any evidence that BP shared the OptiCem model information with the Transocean crew or personnel onshore. Given the importance of the production casing cement job to the integrity of the well, access to OptiCem data was critical to allowing the rig crew to fully understand the risks.

### *C. Gas Flow Potential*

BP witnesses testified that they were not aware of, nor did they review, the gas flow potential calculations included in the OptiCem model report. Brett Cocales, a BP operations engineer, testified that he was "not familiar with gas flow as it relates to cementing."<sup>101</sup> Testimony from BP personnel demonstrated that they did not fully understand the gas flow potential outputs reflected in the OptiCem models and instead only considered the ECD charts in evaluating the cement model results.<sup>102</sup>

In the OptiCem models, gas flow potential higher than seven is typically considered severe. Despite the severe gas flow potential indicated by its April 18 OptiCem model, Halliburton employees provided the following testimony demonstrating that they believed the OptiCem models did not raise immediate safety concerns:

---

<sup>101</sup> Testimony of Brett Cocales, Joint Investigation Hearing, August 27, 2010 at 155.

<sup>102</sup> Cocales Testimony at 22; Testimony of David Sims, Joint Investigation Hearing, August 26, 2010 at 223.

- Nathaniel Chaisson, a cementing engineer, stated that “poor centralization does not equate to complete blowout;”<sup>103</sup>
- Jesse Gagliano, a cementing engineer, stated that “channeling does not equal a blowout;”<sup>104</sup> and
- Vincent Tabler, a cementer, stated that, in a meeting on April 19, no one raised concerns about the risk associated with the production casing cement job.<sup>105</sup>

It is not common for operators in the Gulf of Mexico to complete cement jobs that present a severe gas flow potential, although cement jobs with these conditions have been completed successfully in the past. Halliburton provided the Panel with information about the number of cement jobs it conducted between January 1, 2005 and April 20, 2010 where the gas flow potential was calculated to be severe. The Panel reviewed records for jobs performed in the Gulf of Mexico, and offshore in Brazil, Norway and the United Kingdom, which showed that 53 of these jobs had severe gas flow potential. Eleven of these 53 cement jobs were performed in the deepwater of the Gulf of Mexico. BP was the operator on two of Halliburton’s severe gas flow potential cement jobs conducted in the deepwater Gulf of Mexico.

#### **D. Centralizers**

A centralizer is a device that fits around a casing string or liner to ensure centering of the casing in an open hole. Centralization of casing strings and liners facilitates the efficient placement of cement around the casing string. Even though the Macondo well was a straight hole, BP used centralizers because the diameter of the production casing does not always align exactly with the center of the wellbore and, therefore, without centralizers the production casing could rest along the sides of the wellbore. Casing string contact with the side of the wellbore can lead to void spaces in the cement job (referred to as “channeling”).

On April 14, four days before the production casing was scheduled to be run, BP had only six centralizers available on the *Deepwater Horizon* for the production casing cement job. The six centralizers already on the rig had built-in stop collars. Stop collars prevent a centralizer from moving up and down the casing and built-in stop collars are integrated into the centralizer. Other

---

<sup>103</sup> Testimony of Nathaniel Chaisson, Joint Investigation Hearing, August 24, 2010, at 419.

<sup>104</sup> Gagliano, testimony at 264.

<sup>105</sup> Testimony of Vincent Tabler, Joint Investigation Hearing, August 25, 2010, at 12-13.

centralizers use stop collars that are separate components and slip onto the centralizers. Because the April 15 OptiCem report predicted less channeling with a total of 21 centralizers, the BP Macondo well team located 15 additional centralizers from Weatherford, an oil-field service company, and arranged for them to be sent to the BP shore base in Houma, Louisiana, from which the centralizers would be flown to the rig.<sup>106</sup>

A Weatherford representative, Daniel Oldfather, however, testified he could not locate all the centralizer materials at the BP shore base.<sup>107</sup> While the 15 centralizers were at Houma, additional centralizer components, including stop-collars and epoxy were not available.<sup>108</sup> Oldfather further testified that a BP representative told him that the additional components would be shipped to the rig by boat.<sup>109</sup> On April 16, Oldfather flew to the *Deepwater Horizon* with the 15 centralizers and waited for the other centralizer components to arrive.<sup>110</sup> When the 15 centralizers arrived on the rig, Brian Morel examined them and told John Guide, the BP wells team leader, that the 15 centralizers did not have stop collars on them but that they would have “plenty of time” for the stop collars to be delivered to the rig.<sup>111</sup> BP had planned to send the additional centralizer components by boat, which was to arrive the afternoon of April 16. By 10:00 p.m. on that date, the boat had not arrived.<sup>112</sup> On the morning of April 17, Morel told Oldfather that BP would run only the six centralizers with built-in stop collars that BP already had available on the rig. Oldfather testified that he never determined whether the shipment with the additional centralizer components arrived on the *Deepwater Horizon*.<sup>113</sup>

Guide explained in an email and in his testimony before the JIT the rationale for BP’s decision to use only 6 centralizers rather than the 21 centralizers that been planned. According to Guide, BP believed based on its previous experience that the 15 centralizers delivered to the rig, which had separate stop collars that needed to be slipped onto the centralizers, might come apart and clog the wellbore.<sup>114</sup> Finally, Guide noted that it would have taken an

---

<sup>106</sup> Testimony of Daniel Oldfather, Joint Investigation Hearing, October 7, 2010, at 7.

<sup>107</sup> *Id.*

<sup>108</sup> *Id.* at 8-9.

<sup>109</sup> *Id.*

<sup>110</sup> *Id.* at 9-12.

<sup>111</sup> BP-HZN-MBI000255668.

<sup>112</sup> Oldfather testimony at 11-12.

<sup>113</sup> *Id.* at 12-13.

<sup>114</sup> Guide testimony, July 22, 2010 at 67-68.

additional 10 hours to install 21 rather than 6 centralizers, and he stated that the earlier decision to use 21 centralizers was made by Gregg Walz, BP drilling engineer team leader, and others in his absence.<sup>115</sup>

The Panel found no evidence that BP's decision to use 6 centralizers rather than the 21 recommended by Halliburton was a cause of the blowout.

## *E. Float Collar*

### *1. Float Collar Function*

Float collars are one-way valves installed at or near the bottom of the casing string. When a float collar has been successfully "converted" it will allow fluids to flow in only one direction. A converted float collar allows cement and other fluids to be pumped down the well without reversing direction and coming back up the casing. BP used a Weatherford Model M45AP mid-bore auto-fill float collar in the Macondo well, which is depicted in Figure 4 below.

The float collar uses a double-check valve – a mechanical valve that permits fluid to flow in one direction – that is held open by an auto-fill tube. When running the casing into the well, the auto-fill tube allows mud to flow into the casing, thereby reducing the force exerted by the mud on the formation and helping to prevent loss of fluids into the formation. To convert the float collar, a ball (in this case an "Allamon ball" because the float collar was manufactured by Allamon) rests in the auto-fill tube when running the casing into the well and when mud pumping starts it restricts the flow of mud by diverting the mud through two small ports in the auto-fill tube. Circulation through these ports creates a differential pressure in the float collar, forcing the auto-fill tube out of the float collar and allowing the check valves to close. In doing so, a float collar, which is set near the bottom of the casing string, acts as a check valve and prevents cement that is pumped down through the casing from flowing back into the shoe track (which is the distance between the float collar and end of the casing) once the cement is in place. If the float collar fails to convert, it is possible for "reverse flow" or "u-tubing" flow to occur from the bottom of the casing up the wellbore toward the rig.

---

<sup>115</sup> BP-HZN-CEC022433.

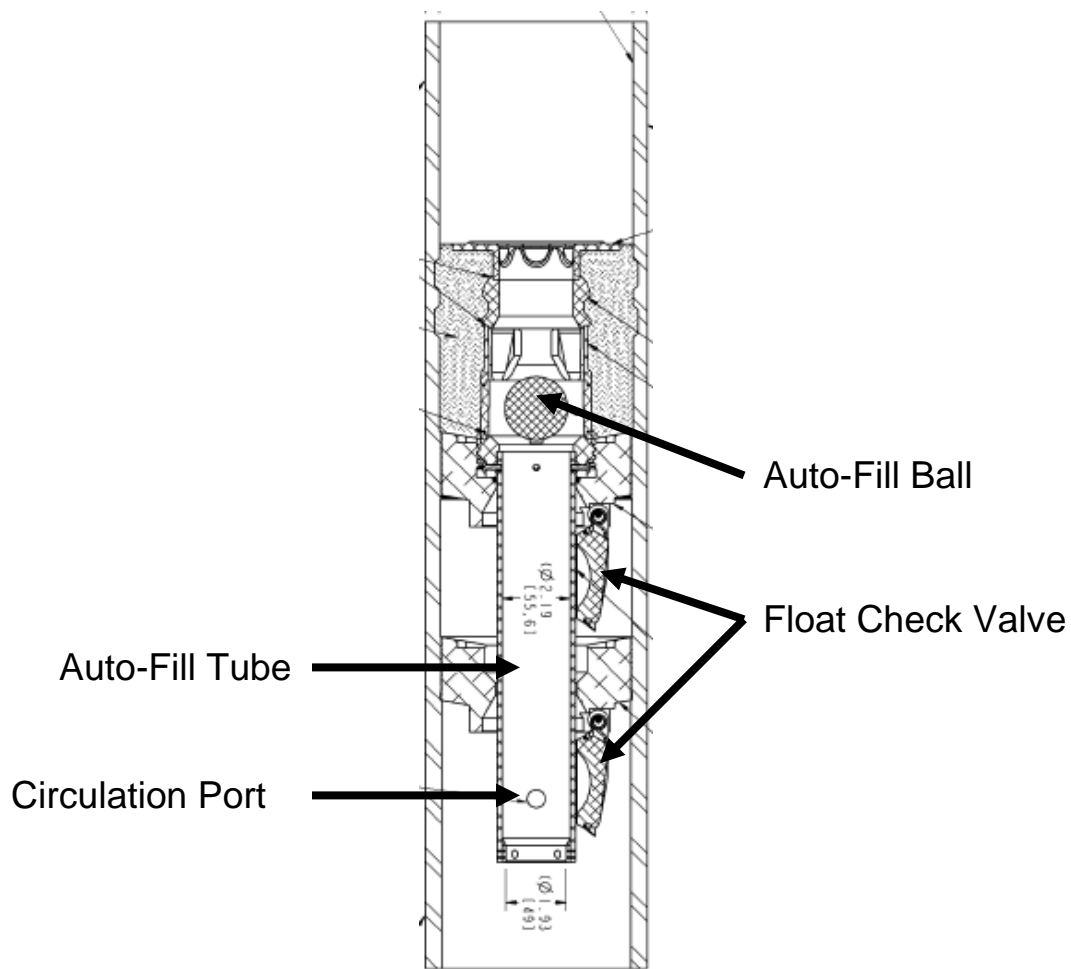

Figure 4 – Float Collar Utilized in the Macondo Well

As discussed above, the float collar was set at 18,115 feet measured depth, within the primary hydrocarbon reservoir sands (see Figure 2, above). Typically, an operator sets the float collar below the primary hydrocarbon sands to allow for perforation of the pay zone without the need to drill out the float equipment to get below the pay zone during the completion of the well. In addition, the lower primary sand was less than 100 feet from the bottom of the production casing shoe.<sup>116</sup> Normally, an operator would set the production casing shoe 200 to 300 feet below the primary sand to improve the chances of proper isolation of the pay sand.

---

<sup>116</sup> BP-HZN-MBI00018459.

## 2. *Float Collar Conversion Attempts*

On April 18, at approximately 3:30 a.m., the *Deepwater Horizon* crew started running the 9-7/8 x 7 inch long string production casing and finished the procedure at 1:30 p.m. on April 19.<sup>117</sup> After the casing string landed, the crew attempted to convert the float collars in preparation for pumping production casing cement into the well. Based on information that Weatherford supplied, the float collar conversion should have occurred with a differential pressure of between 400 and 700 pounds per square inch (psi), which required a calculated pump rate of five to seven barrels per minute (bpm). A successful conversion of the float collar would result in the float collar's two check valves moving into a closed position, which should prevent flow of cement (or other fluids) up the casing.

The crew made nine attempts to establish circulation through the float collar in an effort to convert the float collar, increasing pressure on each attempt. The crew finally established circulation on the ninth try, at pressure of 3,142 psi. After circulation was established, the circulation pressure was only 340 psi, which was lower than the pressure of 570 psi predicted by Halliburton's computer model. The pump rate required to move mud into the well and through the shoe track (circulating pressure) never exceeded approximately 4 bpm, which was less than the five to seven bpm that Weatherford determined was necessary for float collar conversion.

Because Bob Kaluza, the BP well site leader, was concerned about the low circulating pressure, he directed the rig crew to switch circulating pumps to determine whether doing so would improve circulating pressure. They eventually concluded that the pressure gauge they had been relying on was inaccurate.<sup>118</sup>

Nathaniel Chaisson, an onsite Halliburton engineer, testified that, after circulation was established, Kaluza said "I'm afraid that we've blown something higher up in the casing joint." Chaisson understood Kaluza to mean that he believed they had not been circulating mud from the bottom of the well up, but

---

<sup>117</sup> BP Daily Drilling reports 4/19, 4/10 (BP-HZN-MBI-000136936; BP-HZN-MBI-000136946).

<sup>118</sup> Cocalles testimony at 71-75.



rather were circulating it from some point higher in the well casing.<sup>119</sup> According to notes of Kaluza's interview with BP internal investigators, Kaluza discussed with Guide and Keith Daigle, a BP well operations advisor, what Kaluza considered to be the anomaly of the low circulation pressure after circulation was established. In that conversation, Guide directed Kaluza to pump cement and did not instruct him to redo tests or to take any other precautions (for example, setting another cement barrier on top of the wiper plug or more closely monitoring well flows and pressures after completion of the cement job).<sup>120</sup>

Despite Kaluza's misgivings about low circulating pressure, the BP team on the *Deepwater Horizon* concluded that the float valves had in fact converted and therefore continued to the cement pumping phase of the temporary abandonment operation.

### 3. *Problems with Float Collar Conversion*

The cementing crew believed that the float valves converted and, therefore, proceeded to pump cement into the well, even though there was evidence that the conversion never occurred. Without proper conversion of the float collar, cement and other fluids would have a path to flow back up the casing to the rig floor. Following the blowout, BP contracted Stress Engineering to conduct a post-incident analysis on float collars similar to that used on the Macondo well.<sup>121</sup> Stress Engineering's report concluded that the well "experienced a blockage that prevented the float collar from converting during steady state flow."<sup>122</sup> Data analyzed by Stress Engineering supported the likelihood that a blockage was present from as early as when the diverter was closed using the Allamon ball, up through BP's final attempt to convert the float collar.<sup>123</sup> Stress Engineering could not determine whether the blockage occurred at the float collar or at the reamer shoe.<sup>124</sup>

---

<sup>119</sup> Nathaniel Chaisson testimony at 432-433.

<sup>120</sup> BP-HZN-MBI00021271.

<sup>121</sup> *Horizon Incident Float Collar Study-Analysis*, Stress Engineering Services, November 22, 2010 (BP-HZN-MBI00262898).

<sup>122</sup> *Id.*

<sup>123</sup> *Id.*

<sup>124</sup> The float collar and the reamer shoe were the two likely locations for blockage because they each have flow-directed ports that can become blocked with lost circulation material or other debris. The reamer shoe ports can also become plugged as they are lowered into the hole. When lowered, the shoe ports can scrape against the open hole section, which can force debris into the shoe ports and clog them. BP's Brian Morel told BP investigators that he believed at the time of the attempted float collar conversion that the reamer shoe was plugged. BP-HZN-MBI00021304.

The Panel found additional evidence that a blockage may have been present at the beginning of the production casing cement job.<sup>125</sup> Earlier in the procedure, the crew landed a bottom wiper plug on the float collar in order to establish a separation between fluids (spacer and mud) already present in the well and in order to prevent contamination of the cement. After the wiper plug landed on the float collar, pressure was applied to rupture a burst disk in the wiper plug, which would allow circulation of the cement job to continue. The burst disk was designed to rupture at between 900 psi and 1,100 psi, but the disk did not actually rupture until the pressure reached 2,900 psi.

BP might have been able to reduce the likelihood of float collar blockage by installing a float collar that was more debris-tolerant than the float collar used on the Macondo well. Because of the numerous lost circulation events in the well, BP had to use lost circulation material several times. When there is such material in the well, drillers sometimes use debris-tolerant float collars to reduce the chances that the material might lead to a blockage. Indeed, during the attempted float collar conversion, one of BP's contractors suggested to Mark Hafle, a BP drilling engineer, that BP use a more debris-tolerant float collar in the future.<sup>126</sup> Hafle's response was that the float collar "shifted at 3140 psi. Or we hope so."<sup>127</sup> This response suggests that Hafle could not verify that the float collar had converted, nor could he explain why it took so many tries to convert the float collar.

The Panel did not find sufficient evidence to determine what caused the blockage that affected the float collar.

#### *F. Cementing the Macondo Production Casing*

The April 19 cement job was performed according to the procedures detailed in the April 18 OptiCem report.<sup>128</sup> However, BP used only six centralizers in the well, rather than the seven centralizers recommended and assumed in the April 18 model. Prior to cementing, BP did only a partial

---

A reamer shoe is a piece of equipment that guides casing towards the center of the hole as it is lowered down the wellbore.

<sup>125</sup> IADC report 4/19/10; Sperry Sun rig data.

<sup>126</sup> BP-HZN-MBI00257031.

<sup>127</sup> *Id.*

<sup>128</sup> BP-HZN-CEC000011406.

wellbore circulation because it was concerned about additional lost returns that could result from a complete bottoms-up circulation.<sup>129</sup>

On April 19, Halliburton pumped the following fluids down the wellbore: base oil, spacer fluid, unfoamed lead cement, foamed (or nitrified) cement that would go in the annulus, tail cement and additional spacer.<sup>130</sup> After pumping these fluids, Halliburton pumped mud down the well to move the cement into place.<sup>131</sup> After about three and a half hours, the cement crew completed displacement, and both plugs landed, or were “bumped,” with an estimated 100 psi of lift pressure (350 psi circulating to 450 psi) before bumping the top cement plug.<sup>132</sup> The crew conducting the cement job believed they had received full returns throughout the job, meaning that the crew believed that little or no mud had been lost into the formation during the cement job.<sup>133</sup> Brian Morel, who was usually based in Houston, had been on the rig during the cement job and sent an email before he left the rig, saying that “... the cement job went well. Pressures stayed low, but we had full returns the entire job, saw 80 psi lift pressure and landed out right on the calculated volume.”<sup>134</sup>

### 1. *Float Check*

After finishing the cement job, the cementing crew conducted a float check intended to confirm that the float valves had properly closed and, therefore, would prevent any flow back up the well. Vincent Tabler, the Halliburton crew cementer and Lee Lambert, a BP well site leader trainee, stood at the cement unit (a vessel on the rig that injects cement into the well) to verify that the checks were holding. They allowed mud to “flow back until it was probably what we call a pencil stream, and then it quit for a little while, and then when the rig would heave, it would give another little pencil stream,” Tabler said, “I know it was a good 15, 20 minutes that we watched it.”<sup>135</sup> At the conclusion of the float check, the crew concluded that the float valves were holding. The cementing crew completed this job approximately two hours after the cement placement.

---

<sup>129</sup> Guide testimony, July 22, 2010, at 150-151.

<sup>130</sup> See Halliburton post-job nitrified cementing report and job log (Appendix F).

<sup>131</sup> BP-HZN-MBI-00137365.

<sup>132</sup> “Bumping the cement plugs,” refers to the process by which the rig crew tests whether the cement plugs are in the proper place. The crew pumps fluid and looks for a pressure spike that indicates that the cement plug has “landed” in place.

<sup>133</sup> Nathaniel Chaisson email to Jesse Gagliano, April 20, 2010.

<sup>134</sup> BP-HZN-MBI00129052.

<sup>135</sup> Tabler testimony at 22.

## 2. *Cement Job Returns*

During the cementing operation for the production casing, rig personnel continuously monitored fluids being pumped into and flowing out of the well. The rig crew calculated the quantity of fluids pumped into the well using the pump's piston volume output and efficiency. Piston volume is calculated using the pump's liner inside diameter and stroke length efficiency. Sensors on the pump measure how fast the pump is moving instead of directly measuring the volume of fluid being pumped. Flow out of the Macondo well could be measured several ways, including by monitoring pit volumes,<sup>136</sup> monitoring Transocean's flow paddles,<sup>137</sup> or monitoring the sonic and radar sensors (flow-out meters) located in the return flow line.<sup>138</sup> Monitoring the return flow line would provide the most accurate measure of fluid volumes out of the well. The flow-out meter has a 10 percent margin of error and must be based on properly calibrated devices. Recalibration of the flow-out meter is frequently necessary due to rig movement, ballasting, crane operations, sea movement, and other factors.

The rig crew observed that cement displacement occurred at a rate of approximately 4 bpm, and they believed that full returns were achieved while circulating.<sup>139</sup> Dr. John Smith, an expert retained by the Panel, calculated that both the main pit volume record and the calculated cumulative flow-out versus flow-in indicated that about 2.3 bbls of mud was lost during the cement job. John Gisclair of Sperry-Sun performed a post-job review of the flow-in and flow-out data and agreed with Dr. Smith's report that if the sensors and paddles had been properly calibrated, the accuracy of the flow-out volumes should have been within 5 to 10 percent of the recorded data.<sup>140</sup> In testimony, however, Gisclair cautioned that "flow-out is never intended to be an actual measurement of volume. If you want to see the volume, the actual amounts of a gain or a loss,

---

<sup>136</sup> Pit volume refers to the amount of mud in any of the rig's mud pits at a given time.

<sup>137</sup> Transocean's "Hitec" monitoring system on the rig had paddle-type sensors. As fluid rushed past, the fluid pushed and lifted the paddle. The system calculated flow rate based on how much the paddle moved.

<sup>138</sup> The return flow line was the conduit within the pit system.

<sup>139</sup> BP-HZN-MBI137370.

<sup>140</sup> Testimony of John Gisclair, Joint Investigation Hearing, October 8, 2010, at 100.

you would always use the pit volumes, you would never use the flow-out over a given time.”<sup>141</sup>

The Panel independently assessed the difference between the flow-in and flow-out data and calculated that a maximum of approximately 80 bbls of fluids (+/- 10 percent based on the flow-in and flow-out data) could have been lost during the cementing job. Using Sperry-Sun data of flow-in and flow-out, measured in gallons per minute and recorded every five seconds, the Panel generated a flow-out vs. flow-in chart (Figure 5). The Panel converted the Sperry-Sun data from gallons per minute to barrels per minute. The chart's x-axis shows the time (hours/minutes/seconds) during which the cement job occurred at the Macondo well. On the y-axis, the flow-in value was plotted against the flow-out value in barrels per minute. The difference between the flow-in and flow-out values throughout the duration of the cement job was approximately 80 barrels. Assuming a 10% margin of error in the flow-out meter, the Panel calculated that an estimated 72 to 88 bbls of fluids could have been lost during the production casing cement job.

This possible range of loss exceeded the entire volume of cement pumped during the production casing cement job. This could indicate that over-displacement of cement occurred in the shoe track. In other words, the cement could have been pumped into the well, past the shoe track, which would have left spacer and no cement in the shoe track to isolate the center of the production casing. If over-displacement occurred, it would have resulted in insufficient cement coverage in the shoe track.

---

<sup>141</sup> *Id.* at 100-101.

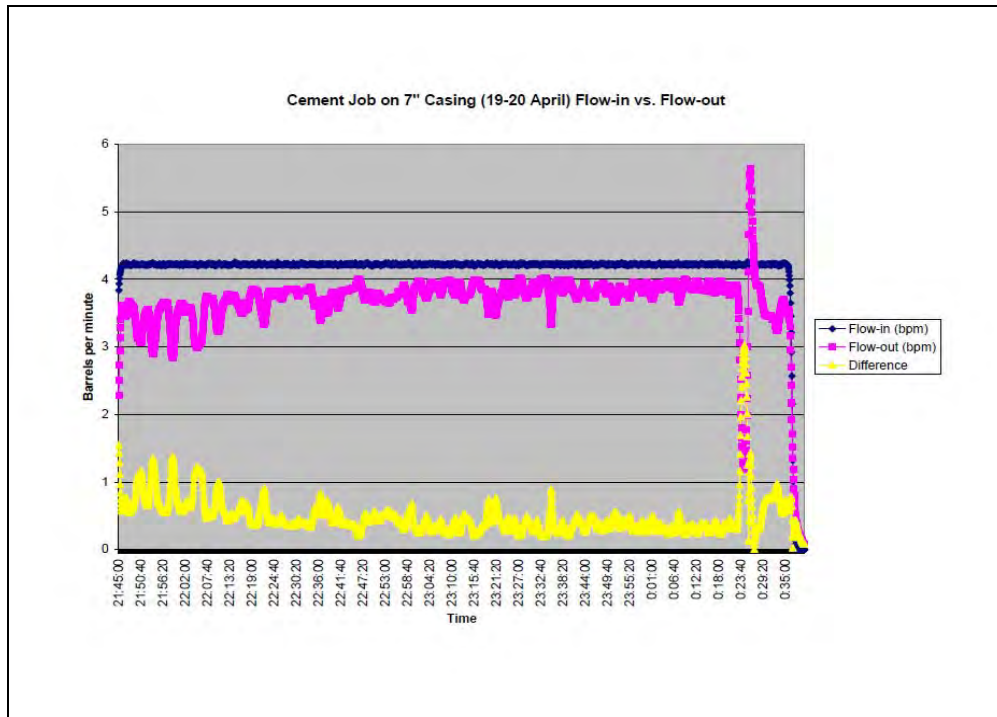

Figure 5 - Flow-out vs. Flow-in on the Production Casing Cement Job (Calculated by Panel)

### G. Industry Standards for Cementing

API RP 65 contains recommended practices focused on the drilling and cementing of casings in the shallow sediments of deepwater wells in which highly permeable and over-pressured sands are found.<sup>142</sup> In connection with the production casing cement job on the Macondo well, BP diverged from a number of API RP 65 recommended practices.

API RP 65 Section 7.5 provides the following guidance on preventing cement from being displaced by drilling mud:

If casing is not to be run to bottom, the “rat hole” should be filled with a higher weight mud to prevent cement from falling into the rat hole and displacing rat hole fluid into the cement column, thus compromising the cement’s properties. The fluid should be of adequate density and properties that there will not be a tendency for the fluid to swap with the cement as it is being placed.

<sup>142</sup> API RP 65 (2002).

Notwithstanding the specific guidance provided by API RP 65, the rig crew filled the rat hole in the Macondo well with 14.0 ppg synthetic oil based mud (SOBM) that was lighter than the cement slurry design.<sup>143</sup> The tail cement was 16.74 ppg.<sup>144</sup> Therefore, the density of the mud the rig crew pumped into the well was not adequate to prevent the type of “fluid inversion” (swapping of fluid and cement) that could compromise the integrity of the cement job.

API RP 65 Section 8.2 addresses well preparation using conditioning fluids. It states that:

Well preparation, particularly circulating and conditioning fluids in the wellbore, is essential for successful cementing ... Common cementing best practice is to circulate the hole a minimum volume of one bottoms-up once casing is on bottom.

As discussed in detail above, BP only partially circulated the Macondo well prior to cementing.<sup>145</sup>

#### 1. *Halliburton’s Primary Cementing Best Practices*

Consistent with API RP 65, Halliburton’s internal cementing best practices document also advises that full well circulation be performed prior to cementing, that lighter weight fluid be used in the rat hole, and that adequate centralization be installed in the well. Halliburton also recommends that, to improve the probability of success in the primary cementing job, “[t]he best mud displacement under optimum rates is achieved when annular tolerances are approximately 1.5 to 2.0 inches.” As discussed above, the annular tolerance on the Macondo well was only ¾ inches for the production casing.

Halliburton’s best practices document also addresses gas flow potential. It states:

Although gas flow may not be apparent at surface, it may occur between zones, which can damage the cement job and eventually lead to casing

---

<sup>143</sup> A rat hole is the extra space drilled beyond the last hydrocarbon zone of interest so that logging tools (used to evaluate the zone of interest) can be run.

<sup>144</sup> BP-HZN-CEC0011406.

<sup>145</sup> BP-HZN-MB1-00021304.

pressure at the surface. The OptiCem program can be used as a tool to determine the gas flow potential of any primary cement job.

While BP used Halliburton's OptiCem model, it did not focus on the gas flow potential issues raised by the model. In addition, Halliburton's best practices document recommends that a cement evaluation log be run to evaluate the quality of the cement job.<sup>146</sup> As discussed below, BP did not run a cement evaluation log for the Macondo well.

## 2. BP Cement Evaluation Log Requirement

In anticipation of potential fluid losses during the production casing cement job, the BP Macondo well team positioned a logging crew and evaluation tools on the rig to run a cement evaluation log. A cement evaluation log is used to enable a crew to evaluate the quality of a cement job and whether the cement in the annular space set up successfully. If the log indicates problems with the cement, the crew can pump additional cement to remediate the primary cement job.

BP's Mark Hafle prepared a decision tree to determine whether BP would run the cement evaluation log.<sup>147</sup> According to the decision tree, rig personnel were to determine whether the cement placement went as planned by checking for lift pressure of approximately 100 psi (60 psi more than expected) and evaluating whether there had been any apparent fluid losses. Rig personnel observed these indicators and concluded that the cement job had gone as planned. On the morning of April 20, the BP Macondo well team decided not to run a cement evaluation log.<sup>148</sup>

BP's engineering technical practices require that personnel determine the top of cement by a "proven cement evaluation technique" if the cement is not 1,000 feet above any distinct permeable zones.<sup>149</sup> The acceptable proven techniques identified in BP's internal guidelines are cement evaluation logs, cement column back pressure, and temperature logs. BP's guidelines do not

---

<sup>146</sup> Halliburton Deepwater Primary Cementing: *Beyond the Shallow Water Flows*, Chapter 7: Post Job Procedures and Analysis (1997).

<sup>147</sup> BP Production Casing and TA Forward Planning Decision Tree, April 14, 2010. (BP-HZN-MBI00010575) (Appendix L).

<sup>148</sup> Guide testimony, July 22, 2010, at 43-44.

<sup>149</sup> BP ETP GP 10-60 Zonal Isolation Requirements During Drilling Operations and Well Abandonment and Suspension (BP-HZN-MBI00193549).



identify lift pressure or lost returns to be proven techniques for evaluating a cement job.<sup>150</sup> Thus, Hafle's decision tree on whether to direct the Schlumberger crew to run the cement evaluation log was inconsistent with BP's own guidelines.

Schlumberger told the Panel that it is uncommon but not unheard of for operators to cancel ordered services, such as cement evaluation logs, after the crew arrives at the facility. Schlumberger reviewed deepwater statistics for a 30-month period and found that Schlumberger actually performed 71 of the 74 cement evaluations originally ordered by operators during that period.

Since the Panel concluded that the cement in annulus did not fail, it found that BP's decision to not perform a cement evaluation log was not a cause in the well failure.

---

<sup>150</sup> *Id.*

#### IV. Possible Flow Paths

The Panel identified three possible paths by which hydrocarbons could have flowed up the well to the rig during the initial stage of the blowout: (1) up the production casing annulus cement barrier and upward through the annulus and the wellhead seal assembly;<sup>151</sup> (2) up the production casing and related components from above the top wiper plug located on the float collar at 18,115 feet; or (3) up the last 189 feet of the production casing (the “shoe track”).

##### *Scenario 1: Production Casing Annulus Cement Barrier and the Wellhead Seal Assembly*

Under this scenario, hydrocarbons would have flowed from the reservoir up the backside of the tapered casing string, and through the seal assembly into the riser. If this had occurred, the nitrified annular cement intended to isolate the hydrocarbon zone(s) at the production interval would have failed, the casing would have lifted or floated, and the seal assembly would have failed in conjunction with the casing lifting. This potential flow path is illustrated in Figure 6, below.

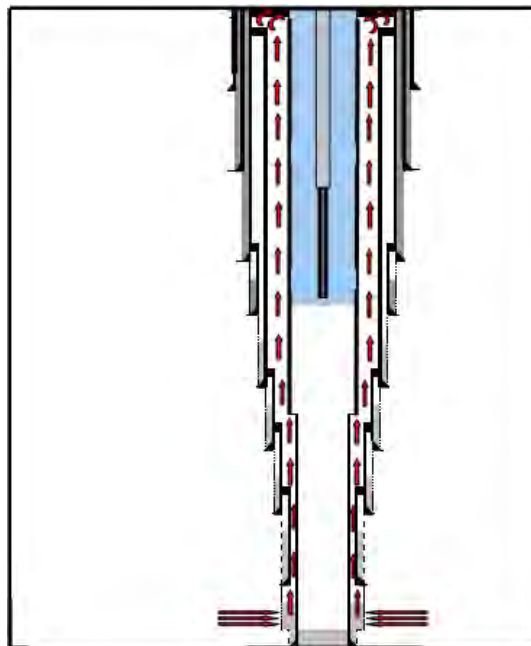

Figure 6 – Flow Up the Annulus and Through the Seal Assembly

---

<sup>151</sup> The seal assembly is a metal element that is the interface between the casing hanger and the wellhead.

On April 19, the day before the blowout, BP pumped cement down the production casing and up into the wellbore annulus above the uppermost hydrocarbon reservoir to prevent hydrocarbons from entering the wellbore. As discussed above, the annulus cement that was placed across the main hydrocarbon zone was a lower density, nitrified (foam) cement slurry. At the time of the blowout, the seal assembly had not yet been mechanically locked to the wellhead housing.

To analyze the probability of this scenario the Panel commissioned Keystone Engineering Inc. (“Keystone”) to conduct a buoyancy casing analysis. Keystone analyzed eight production casing static force conditions that could have acted upon the production casing and wellhead hanger, and possibly resulted in movement of the casing. Keystone’s analysis found that six of these eight scenarios were unlikely to have occurred. Keystone presented two remaining possible scenarios under which seal movement could have resulted from well pressure and forces. However, the Panel later ruled out both of these scenarios because well intervention operations following the blowout showed that the wellhead seal assembly had, in fact, remained intact during the blowout.<sup>152</sup>

When the Macondo well was secured after the blowout, intervention work began under the direction and supervision of the Unified Area Command with input from BOEMRE, including the Panel and other federal agencies.<sup>153</sup> This intervention work required the participation of companies involved in the drilling of the original Macondo well.

During the well intervention operations, observations using remotely operated vehicles (ROVs) found that the Macondo wellhead seal assembly was intact. On September 9, 2010, technicians from Dril-Quip Inc., a contractor involved in the intervention operations, used a lead impression tool to take an impression of the hanger and seal assembly. A lead impression tool is a high tolerance measurement tool that is able to detect changes in equipment to within fractions of an inch. Based on this lead impression, the technicians on the Development Driller II (DDII) relief well operation concluded that the 9-7/8 inch

---

<sup>152</sup> Keystone Report, September 2010.

<sup>153</sup> The Unified Area Command refers to the unified, interagency response to the *Deepwater Horizon* oil spill.

hanger and seal assembly remained properly seated in the 18-3/4 inch high pressure housing, where it had been placed on April 19 prior to the blowout.<sup>154</sup>

Additional evidence from the intervention operations also tends to eliminate this first well flow scenario. On September 10, during the well intervention operation, BP conducted a positive pressure test of the 9-7/8 inch production casing in the Macondo well by pumping 6 bbls of 13.2 ppg drilling mud down the BOP kill line and reached an instantaneous shut-in casing pressure (ISICP) of 4,270 psi. The kill line was then shut in and, after 30 minutes, the shut-in pressure remained at 4,158 psi, therefore revealing no flow through the annulus.

On September 11, following installation of the lock-down sleeve, BP successfully pressure tested the lock-down sleeve seal to 5,200 psi, which indicated that the well hanger was properly seated because otherwise, annular flow would have lifted the hanger.<sup>155</sup>

On September 22, Schlumberger used an isolation scanner tool to log the characteristics of fluid in the annulus between the mud line and 9,318 feet measured depth.<sup>156</sup> This log evaluated, among other things, whether the fluid in the annulus included “free gas.” Based on the logging data, Schlumberger determined that free gas was not present in the annulus below the BOP. The absence of free gas in the annulus provides strong evidence that hydrocarbons were not present in the annulus during the blowout.

On October 7, the intervention team perforated the 9-7/8 inch production casing between 9,176 feet and 9,186 feet to monitor pressure and returns.<sup>157</sup> The drilling mud in the interior of the casing at the time was approximately 14.3 ppg synthetic-based mud (“SBM”). Hydrocarbons, if present in the annulus, would have exhibited a much lower density. When fluids of different densities meet at an opening, gravity and the “u-tube” effect typically cause the more dense fluid

---

<sup>154</sup> DDII IADC Report, 9/11/10 (TRN-USCG\_MMS-00043342).

<sup>155</sup> DDII IADC Report, 9/11/10 (TRN-USCG\_MMS-00043342). A “well hanger” is a long string of production casing that hangs from a casing hanger inside the wellhead.

<sup>156</sup> DDII IADC Report 9/22/10 - TRN-USCG\_MMS-00043388. An isolation scanner tool is used to evaluate a cement job by taking measurements to help distinguish solids from liquids in the wellbore. The tool can identify potential channeling and can evaluate whether a cement job has achieved zonal isolation.

<sup>157</sup> DDII IADC Report 10/7/10 (TRN-USCG\_MMS-00043449). This was done using a perforating gun and well testing equipment.

to flow into the space occupied by the lower density fluid. No “u-tube” flow of the 14.3 ppg mud from the casing to the annulus occurred on October 7, indicating that hydrocarbons were not present in the annulus.<sup>158</sup>

After the BOP stack was recovered from the seabed, pictures taken from the DDII relief well rig of the hanger and seal assembly showed no erosion. Had hydrocarbons flowed up the annulus, the outside of the hanger and seal assembly likely would have shown effects of erosion due to hydrocarbon flow.

Because the evidence does not support the theory that hydrocarbons flowed up the annulus, the Panel concluded that the nitrified cement slurry used in the annulus likely did not fail.

***Scenario 2: Production Casing and Related Components from above the Top Wiper Plug at 18,115 feet***

Under this scenario, hydrocarbons would have flowed from the reservoir through the crossover joint of the tapered casing string, into the well and up the riser to the rig. The Panel considered the crossover point to be a possible source of flow because it was manufactured separately from the other tubular elements in the well. If hydrocarbons had flowed in this path, it would mean that the annular cement isolating the hydrocarbon zones at the production interval had failed and the casing had failed at the crossover joint. These failures would have resulted in hydrocarbon flow out of the well and up the riser. This scenario is depicted in Figure 7 below:

---

<sup>158</sup> “U-tubing,” or reverse flow, occurs when fluids flow in the reverse direction and back up the inside of the casing. The “u-tube effect” is the practice of putting a dense slugging pill (mud that is more dense than the mud in the drill pipe and the wellbore annulus) into the drill pipe in order to pull a dry string. The pill is pumped to the top of the drill string to push mud downward, out of the pipe, thus keeping the upper strands of the pipe empty.

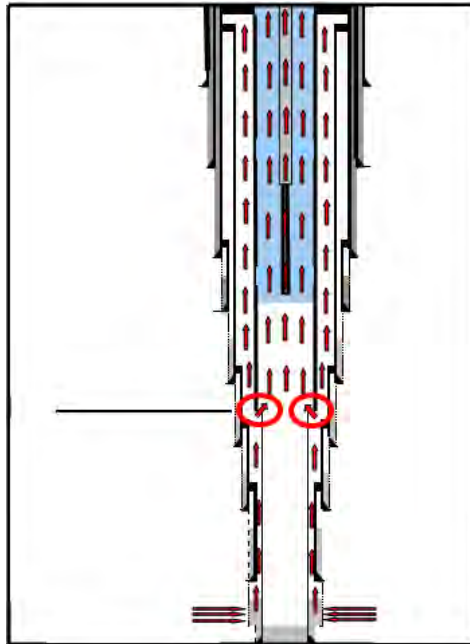

Figure 7 – Flow Up the Annulus and Through Production Casing Crossover Joint

After cementing the production casing, the *Deepwater Horizon* crew conducted a successful 2,500 psi positive casing test against the top wiper plug.<sup>159</sup> Although this pressure test (250 psi low/2,500 psi high) did not confirm a seal below the top wiper plug at the top of the float collar, it did provide evidence that the 9-7/8 x 7 inch production casing and related components that comprise this string above the top wiper plug were most likely leak-free.

Like Scenario 1, Scenario 2 posits that hydrocarbons flowed through the annulus. Forensic evidence gathered during well intervention efforts casts substantial doubt on this theory. As discussed above, the Panel found no evidence of erosion of the hanger and seat assembly. Had hydrocarbons flowed along this path, erosion effects likely would have been visible. In addition, as mentioned above, logging data show that free gas was not present in the annulus below the BOP.

For all of these reasons, the Panel does not believe that Scenario 2 represents a likely explanation for the flow path of hydrocarbons during the blowout.

---

<sup>159</sup> Smith Report at 8.

### *Scenario 3: Production Casing Shoe Track*

Under this scenario, hydrocarbons would have flowed from the reservoir through the casing shoe, into the well and up the riser to the rig. For this flow path to have occurred, the shoe track cement would have failed. A number of factors could have caused the shoe track cement to fail. First, mud in the wellbore could have contaminated the shoe track cement and caused the cement not to set properly. Second, the shoe track cement might have swapped out with the lighter drilling fluid in the rat hole. Third, some of the shoe track cement could have been lost into the formation. Finally, the failure of the shoe track could have resulted from a combination of these factors. This scenario is represented in Figure 8 below.

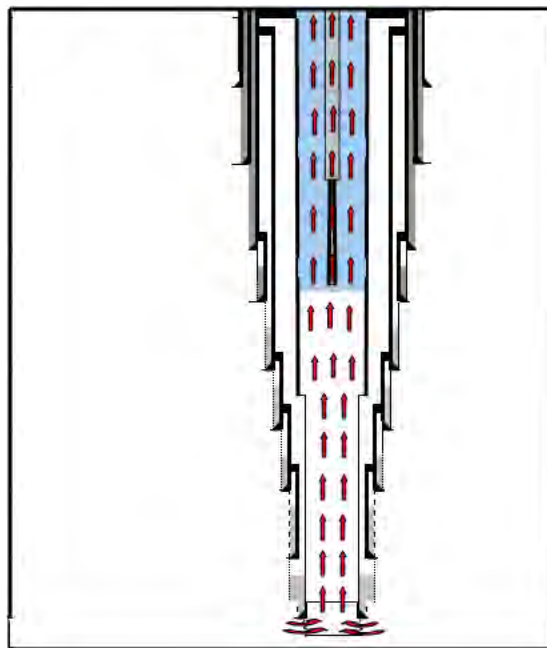

Figure 8 – Flow up the Production Casing Shoe Track

The approximately 189 foot bottom section of the casing in the well, called the shoe track, consisted of sections of casing with a reamer-guide shoe at the bottom and a dual flapper float collar on top. These sections of casing that make up the shoe track are meant to contain the top, or tail cement, which in the Macondo well was unfoamed cement.

The shoe track was designed to prevent u-tubing in two ways: (1) the presence of 189 feet of cement as a barrier and (2) the float collar's flow dual flapper valves were designed to allow only one-way flow after conversion.

The float collar dual flapper arrangement is designed to close after the cement is in place (and starts setting up) to prevent any flow-back into the casing (and up the well) caused by hydrostatic pressure differences between the dense cement and drilling mud on the outside of the casing and the less dense displacement fluid on the inside. The float collar also acts as the landing point for the cementing plugs used during the job. The float collar employed a differential fill tube that allowed mud to flow into the casing as it was run into the well. The fill tube in this case was designed to be pumped out of the float collar if the pump rate was higher than five barrels per minute. The position of the top of the float collar located at 18,115 feet placed the float collar across the productive reservoir between 18,083 feet and 18,206 feet measured depth.

As described above, the crew had difficulty converting the float collar and may not have achieved conversion despite making nine attempts. There are three possible reasons for the failure of the float collar: (1) the high load conditions required to establish circulation damaged the float collar; (2) the float collar failed to convert due to insufficient flow rate; and (3) the check valves on the float collar failed to seat due to damage, contamination, or the presence of debris. None of these float collar failure scenarios excludes the possibility that the cement could have failed due to defective cement design, contamination of the cement by mud in the wellbore, commingling of cement with nitrogen due to nitrogen breakout from the nitrified foam cement slurry, swapping of the shoe track tail cement with the heavier mud in the rathole, a clogged reamer shoe that possibly altered cement flow-out of the reamer shoe, or some combination of these factors.

The forensic examination of the BOP stack found interior erosion of the blind shear rams, which supports this flow path as the most likely scenario. This erosion detected on the blind shear rams likely resulted from the high pressure flow of hydrocarbons past the rams as a result of the blowout and indicates that hydrocarbons flowed up the well after entering through the shoe track.



## V. Conclusions on Well Design, Cementing, and Flow Path

### A. *Cause of the Failure of the Cement Barrier*

Contamination or displacement of the shoe track cement, or nitrogen breakout or migration, could have caused the shoe track cement barrier to fail. The Panel found evidence that the most likely reason the shoe track cement slurry failed is due to contamination in the rat hole portion of the wellbore and inversion of fluids due to different densities (the mud in the shoe track was lighter than the unfoamed cement slurry). However, the Panel could not definitely rule out nitrogen breakout, migration, or over-displacement in the shoe track. **The Panel concluded that a combination of contamination, over-displacement, and/or possibly nitrogen breakout of the shoe cement were causes of the blowout.**

Contamination of the foamed cement in the annulus by the mud, base oil or cement spacer could have resulted in nitrogen breakout, leading to a failure to achieve zonal isolation of hydrocarbons in the annulus. **The Panel concluded, based upon its review of forensic evidence that established the absence of free gas in the annulus, that contamination or nitrogen breakout did not affect zonal isolation in the annulus.**

### B. *Contributing Causes of the Cement Barrier Failure*

Macondo was an exploratory well with limited offset data, and the differences between calculated and actual pore pressures caused BP to make revisions to the drilling program and casing setting depths, including the depth at which BP set the production casing. BP's internal guidelines stated that drilling would not be stopped in a hydrocarbon interval, unless doing so was necessary because of operational/pressure/safety issues. BP's decision to set the casing was based on well integrity concerns and a potential safety issue associated with a zero drilling margin based on 14.1 ppg pressured formation sand combined with a 12.6 ppg formation pressured zone in the same open-hole section taking losses. Additionally, the production casing string shoe was set in a laminated sand-shale interface at 18,304 feet measured depth, instead of at a consolidated shale strata. Placement of the shoe in a laminated sand-shale zone increased the likelihood of channeling or cement contamination. **The decision to set the production casing in a laminated sand-shale zone in the vicinity of a hydrocarbon interval was a contributing cause of the blowout.**

The mud losses of approximately 15,500 bbls during drilling at Macondo indicated that BP should have taken additional precautions during the production casing cementing operation. **With the known losses experienced in the well, BP's failure to take additional precautions, such as establishing additional barriers during cementing, was a contributing cause of the blowout.**

As discussed above, API RP 65 contains recommended practices regarding cementing operations that, at the time of the Macondo blowout, were used by many operators drilling wells in deepwater in the Gulf of Mexico. Some of the steps that BP took during the cementing of the Macondo production casing were not consistent with API RP 65 recommended practices, including the following:

- BP did not circulate a minimum volume of one bottoms-up (the volume needed to be pumped to push the mud at the bottom of the wellbore to the surface) once the casing was on bottom, and the mud conditioning volume was less than one annular volume;
- With the casing shoe not run to the bottom, BP did not fill the "rat hole" with a higher weight mud capable of preventing cement from falling into the rat hole and thereby displacing rat hole fluid into the cement column and compromising the cement's properties; and
- The hole diameter was less than three inches greater than the casing outside diameter.

With respect to the production casing cement job, BP and Halliburton did not employ the industry-accepted recommended practices described above. **BP and Halliburton's failure to perform the production casing cement job in accordance with industry-accepted recommendations as defined in API RP 65 was a contributing cause of the blowout.**

BP chose to land the float collar across a hydrocarbon-bearing zone of interest in the Macondo well, instead of at the bottom of the shoe. If the float collar had been at the bottom of the shoe, the cement job would likely have been more overbalanced (i.e., greater pressure from the cement relative to the pressures from the well). This increased overbalance would likely have allowed the rig crew more time to recognize that hydrocarbons were flowing in the well and more opportunities to take measures to control the well. **BP's decision to set**

**the float collar across the hydrocarbon-bearing zones of interest, instead of at the bottom of the shoe, was a contributing cause of the blowout.**

The Panel found no evidence suggesting that BP shared with the *Deepwater Horizon* rig crew or Transocean shore-based personnel any of the information available to BP regarding specific risks associated with the Macondo production casing cement job – including the decisions noted above that the Panel determined were causes or contributing causes to the blowout. **BP’s failure to inform the parties operating on its behalf of all known risks associated with Macondo well operations was a contributing cause of the blowout.**

BP made a series of decisions during the days leading up to the blowout without having appropriately analyzed all available information or having first developed certain critical information, including: (1) going forward with the production casing cement job without analyzing compressive strength results from Halliburton; (2) proceeding with the cement job despite failing to fully analyze and evaluate the gas flow potential values in Halliburton’s OptiCem reports; and (3) directing the rig crew to pump cement into the well without referring to data available to engineers onshore that blockage in the collar may have been present during float collar conversion. **BP’s failure to appropriately analyze and evaluate risks associated with the Macondo well in connection with its decision making during the days leading up to the blowout was a contributing cause of the blowout.**

BP did not place any cement on top of the wiper plug. This additional cement would have created another barrier to prevent flow up the production casing that could have been pressure and weight tested. **BP’s failure to place cement on top of the wiper plug was a contributing cause of the blowout.**

### *C. Possible Contributing Causes of the Cement Barrier Failure*

The float collar model used in the Macondo well was not as debris-tolerant (and therefore was more susceptible to blockages) as other models that were available and would have been more suitable in light of the known challenges with the Macondo well. **BP’s decision to use a float collar that was not sufficiently debris-tolerant was a possible contributing cause of the blowout.**

On the Macondo well, BP had the option to temporarily abandon the well without setting a production casing, as it had done previously with the Kodiak, MC 727, Number 2 and Tiber, KC 102, Number 1 wells when faced with similar narrow drilling margins and lost returns at total depth. **BP's decision to set casing in the production interval with known drilling margin limits at total depth was a possible contributing cause of the blowout.**

During the production casing cementing operation, rig personnel continuously monitored the fluids that they pumped into – and that flowed out of – the well. But rather than measuring flow-in directly, rig personnel calculated flow-in based on the pump's piston volume output and efficiency. The crew measured flow-out based on the Transocean flow meter paddles and the Sperry-Sun flow line sonic/radar sensors. The crew also monitored flow-out by pit gain volumes. As discussed above, even with properly calibrated flow measurement devices, there would have been a 10 percent margin of error in the flow-out calculations. Dr. Smith, the expert retained by the JIT, used both the main pit volume data and the calculated cumulative flow-out versus flow-in data to estimate that approximately 2.3 bbls of mud were lost during the production casing cementing operation. The Panel used actual flow values to calculate that the losses amounted to approximately 80 bbls (+/- 10% based on flow-in /flow-out data). **The fact that the *Deepwater Horizon* crew did not have available to them accurate and reliable flow-line sensors during cementing operations in order to determine whether they were obtaining full returns was a possible contributing cause of the blowout.**

There were a number of limitations in the cementing plan that could have contributed to the compromise of the cement job, including the following:

- Reducing the bottoms up circulation from 2,760 bbls to approximately 350 bbls could have increased the likelihood of channeling because: a) there was less cleaning of the wellbore, and b) the reduced bottoms up prevented rig personnel from examining, prior to cementing, the mud for potential contamination by hydrocarbons;
- Pumping cement at the relatively low flow rate of 4 bpm could have decreased the efficiency with which cement displaced the mud from the annular space, thereby increasing the potential for channeling; and

- Limiting the volume of cement to approximately 51 bbls meant that any contamination of the cement by mud could reduce the effective coverage of annular and/or shoe track cement.

**These decisions by BP and Halliburton with respect to planning and conducting the Macondo production casing cement job were possible contributing causes of the blowout.**

BP's well site leaders and the *Deepwater Horizon* rig crew failed to recognize the accumulating risk associated with several possible anomalies that could have contributed to the shoe track cement's failure to prevent hydrocarbon ingress into the well. These problems include:

- The higher pressure needed to convert the float collar from "fill" to "check" (3,142 psi instead of a maximum of 700 psi) could have damaged components of the float collar (including the auto-fill tube and shear pins);
- The float collar may not have converted because the crew used an insufficient flow rate and pressure. The float collar was designed to convert at a range between 5 bpm and 7 bpm, while the actual flow rate never exceeded 4.3 bpm;
- The bottom cement wiper plug that landed on the float collar required 900 psi to 1,100 psi to burst the disk. However, the burst disk did not rupture until 2,900 psi was applied, which indicated that there may have been a blockage in the float collar;
- The check valves on the float collar may not have properly sealed as a result of damage to the flapper valve pins, or related components, or may have only partially sealed as a result of debris across the seal areas;
- Lost circulation material or other debris in the mud system could have led to the need to use increased pressure to convert the float collar. If debris was present, there would be no assurance that conversion could be achieved even with the use of higher pressures;
- The shoe track cement may have been contaminated by mud in the rat hole swapping out with the cement, due to a density differences between the cement and the mud; and
- Except for a couple of surges or spikes, the flow rate used by the crew was too low to convert the float collar.

**The failure of BP's well site leaders and the Transocean *Deepwater Horizon* rig crew to recognize the risks associated with these multiple problems that**

**occurred between April 19 and April 20 was a possible contributing cause of the blowout.**

*D. Flow Path Cause*

*1. Production Casing Annulus Cement Barrier and the 9-7/8 Inch Wellhead Seal Assembly*

As discussed above, the following evidence weighs against the possibility that hydrocarbons flowed through the production casing annulus cement barrier and the 9-7/8 inch wellhead seal assembly:

- 1) On September 9, 2010, Dril-Quip technicians confirmed with a lead impression tool that the 9-7/8 inch wellhead seal assembly remained properly seated in the 18-3/4 inch high pressure housing, where it had been placed on April 19, 2010 prior to the flow of hydrocarbons.
- 2) On September 10, BP conducted a 30-minute pressure test of the 9-7/8 inch production casing annulus that confirmed the lack of annular communication.
- 3) On September 11, the lock-down sleeve seal was successfully pressure tested to 5,200 psi, which tended to prove that the hanger was properly seated.
- 4) On September 22, Schlumberger's logging data determined that "free" gas was not present below the BOP to 9,318 feet measured depth.
- 5) On October 7, BP's perforation of the 9-7/8 inch casing between 9,176 feet and 9,186 feet found that no u-tube flow occurred from the casing to annulus.
- 6) During well intervention operations, ROV observation determined the wellhead seal assembly was intact. In addition, subsequent to removing a portion of the 9-7/8 inch production casing, original 13.8-14.0 ppg mud was discovered between the 16 inch intermediate casing and 9-7/8 inch production casing.
- 7) Pictures taken from the DDII relief well rig at the time the hanger and seal assembly were extracted from outside hanger and seal assembly showed no signs of erosion from annular flow.

**Based on this evidence, the Panel concluded that hydrocarbons did not flow from the production casing annulus cement barrier and the 9-7/8 inch wellhead seal assembly during the blowout.**

2. *Production Casing and Related Components from above the Top Wiper Plug at 18,115 Feet*

The 9-7/8 x 7 inch production casing and related components (including the 9-7/8 x 7 inch cross-over sub and centralizer subs) were successfully pressure tested (250 psi low/2,500 psi high) from above the top wiper plug at 18,115 feet. On September 10, BP conducted a 30-minute pressure test of the 9-7/8 inch production casing annulus that confirmed the lack of flow from the annulus. On October 7, 2010, BP perforated the 9-7/8 inch casing between 9,176 feet and 9,186 feet and determined no u-tube flow occurred from the casing to annulus. **Based on this evidence, the Panel concluded that the well flow did not occur from inside the 9-7/8 x 7 inch production casing or its related components (including the 9-7/8 x 7 inch cross-over sub and centralizer subs) from above the top wiper plug at 18,115 feet.**

3. *9-7/8 Inch Production Casing Shoe Track*

Based on the elimination of the potential flow paths from the previous scenarios, the examination of the blind shear rams that showed interior erosion, presumably from the high-pressure flow of hydrocarbons past the rams in the period after the well event, and the findings contained in the Keystone Engineering Report, the Panel concluded that the most likely path of hydrocarbons during the blowout was through the shoe track. **The Panel concluded that hydrocarbon flow during the blowout occurred through the 9-7/8 x 7 inch production casing from the shoe track as a result of float collar and shoe track failure.**

## VI. Challenges at the Macondo Well

BP and Transocean encountered a number of problems during drilling and temporary abandonment operations at the Macondo well – including kicks, stuck pipe, lost returns, equipment leaks, cost overruns, well scheduling and logistical issues, personnel changes and conflicts, and last minute procedure changes. These problems led rig personnel and others to refer to Macondo as the “well from hell.”<sup>160</sup>

### A. Kicks and Stuck Drill Pipe

BP company records and testimony from rig personnel establish that at least three well control events and multiple kicks occurred during drilling and temporary abandonment operations at the Macondo well. The first well control event occurred on October 26, 2009, when the well was being drilled by Transocean’s *Marianas* rig. The second well control event occurred on March 8, 2010, after the *Deepwater Horizon* had replaced the *Marianas* and resulted in a stuck drill pipe.

It took the crew at least 30 minutes to detect the March 8 kick.<sup>161</sup> This delay raised significant concerns among BP personnel overseeing the operation about the ability of personnel on the *Deepwater Horizon* to promptly detect kicks and take appropriate well control actions.

In a post-blowout interview, John Guide, a BP wells team leader, stated that, at the time (March 2010) he was concerned that the *Deepwater Horizon* team had become “too comfortable” with itself because of its good track record for successfully drilling difficult wells, and that its members missed potential indications of problems during the March 8 event that they should have caught.<sup>162</sup>

Other individuals responsible for operations at Macondo expressed concern about the events of March 8:

---

<sup>160</sup> Testimony of Mike Williams, Joint Investigation Hearing, July 23, 2010, at 35 (stating that the *Deepwater Horizon* crew had used the name “well from hell” on a prior well and also used the term on the Macondo well because on both wells the crew encountered similar lost circulation, stuck pipe, and kick problems).

<sup>161</sup> BP-HZN-MBI00221686.

<sup>162</sup> BP-HZN-BLY00125447.



- David Sims, BP drilling and completions operations manager, expressed concern about the BP well site leaders' well control abilities in an email written following the March 8 kick. He stated that the well site leaders "are not well control experts. They are fantastic drillers – the best in the SPU [BP drilling unit], if not the industry. However, they do not circulate out kicks for a living, especially 1200 feet off bottom with many unknowns."<sup>163</sup>
- Mark Hafle told BP investigators in a post-blowout interview that he believed some of the Sperry-Sun mudloggers did not understand how to monitor the well properly, and that the Sperry-Sun personnel were stretched too thin and did not have enough qualified mudloggers.<sup>164</sup>

Notwithstanding the high level of concern about the March 8 kick and the rig crew's response to the kick, BP did not conduct the type of investigation of the incident required by BP's own policies. BP's drilling and well operations procedures require a well control incident report to be completed and documented in BP's internal reporting system<sup>165</sup> and provide that such incidents should be investigated to determine root causes and to identify ways to prevent reoccurrence.<sup>166</sup> The Panel found no evidence that BP documented the March well control event in its internal tracking system or that it conducted a post-incident investigation to determine the root cause of the delayed kick detection.

Instead of conducting a formal investigation, Guide had discussions with the BP well site leaders and the Transocean rig leaders about the event and the drilling crew's response. Guide told BP investigators in a post-blowout interview that he believed members of the rig crew understood their responsibilities and admitted to him that they "had screwed up" by not catching the kick. Guide also talked to the Sperry-Sun mudloggers about the detection of flow.<sup>167</sup>

BP's in-house group of geological experts, the "Totally Integrated Geological and Engineering Response team" (the "TIGER team"), conducted an

---

<sup>163</sup> BP-HZN-MBI00222540.

<sup>164</sup> BP-HZN-BLY00125470. As discussed previously in this Report, mudloggers have a responsibility to monitor the conditions in the well during drilling operations. Monitoring for potential kicks is among the mudloggers' most important responsibilities.

<sup>165</sup> BP DWOP Manual, Section 15.2.12, BP-HZN-MBI00130846.

<sup>166</sup> BP DWOP Manual, Sections 3.1.5, BP-HZN-MBI00130817.

<sup>167</sup> BP-HZN-BLY00125447.

analysis of the March 8 kick. This was not the type of incident investigation required by the DWOP, but rather a study of the pore pressure and other geological conditions encountered in the well. In an email “re-evaluating how we manage real time pore pressure detection for Macondo type wells,” a BP geologist stated that “we need to have PP [pore pressure] conversations as soon as ANY indicator shows a change in PP” and we “need to be prepared to have some false alarms and not be afraid of it.”<sup>168</sup> He also noted:

Better lines of communication, both amongst the rig subsurface and drilling personnel, and with Houston office need to be reestablished. Preceding each well control event, subtle indicators of pore pressure increase were either not recognized, or not discussed amongst the greater group. It is the responsibility of the mudloggers and well-site PP/FG personnel to openly communicate with the well-site geologist.<sup>169</sup>

This analysis by the TIGER team, which was focused on geological conditions in the Macondo well, was not intended to address the specific ways in which the rig crew should monitor the well. Morel, Hafle and Cocalles presented a document to the TIGER team on March 18 that addressed some of the events of March 8, but this document did not include a discussion of any measures to be implemented to ensure that the rig crew could detect kicks more quickly and effectively.<sup>170</sup> The Panel found no evidence that Morel, Hafle, and Cocalles presented information related to the March 8 kick detection problems to anyone else involved in operations at Macondo.

After the March 8 incident, BP had to abandon the wellbore (leaving behind a number of costly drilling tools) and perform a bypass to continue drilling the well.<sup>171</sup> Responding to the kick and conducting the bypass operation resulted in additional cost and timing delay for the Macondo well.

Except for one person, the rig personnel involved in kick detection and response on March 8, including a mudlogger, drillers, assistant drillers, a senior toolpusher, and toolpushers, were the same individuals on duty on April 20 when the blowout occurred.<sup>172</sup>

---

<sup>168</sup> BP-HZN-MBI00113015.

<sup>169</sup> BP-HZN-MBI00113017.

<sup>170</sup> BP-HZN-BLY00036098.

<sup>171</sup> A bypass or sidetrack operation is performed by drilling a directional hole to bypass an obstruction in the well.

<sup>172</sup> One of the mudloggers on duty on April 20 was not involved in the March 8 kick.

## B. *Scheduling Conflicts and Cost Overruns*

As the *Deepwater Horizon* crew prepared to complete operations at the Macondo well, they were significantly behind schedule. BP stated, in a submission to MMS, that the *Deepwater Horizon* would arrive at BP's Nile well (the next well after Macondo that the *Deepwater Horizon* was scheduled to work on) by March 8, 2010.<sup>173</sup> By early 2010, it became clear to BP that this schedule for the *Deepwater Horizon* rig would not hold.

In addition, as discussed previously in this Report, by the time of the blowout, BP had exceeded its original budget for the Macondo well by \$58.34 million. The Panel collected and reviewed evidence showing that BP personnel were aware of the cost overruns and were concerned about incurring additional costs that they deemed unnecessary. John Guide's testimony suggests that his effectiveness at reducing costs was part of the evaluation of his performance as wells team leader.<sup>174</sup> Correspondence between Guide and others suggested his awareness of others' evaluation of his effectiveness in containing costs. For example, on April 20, Guide responded to an email request from Ross Skidmore, a BP contractor, to conduct a standard procedure that would increase the likelihood of a successful lock-down sleeve installation – a “wash run” that would “avoid a bad LIT [lead impression tool] impression” – by saying “[w]e will never know if your million dollar flush run was needed. How does this get us to sector leadership.”<sup>175</sup>

The Panel found evidence that BP's decision to have the *Deepwater Horizon* crew install the lock-down sleeve, discussed in more detail below, was motivated by cost-savings. A lock-down sleeve is a piece of equipment necessary for the production of a well. It connects and holds the production casing to the wellhead during production, thereby protecting the connection from the pressures generated by a flowing well. Lock-down sleeves are often installed by lower cost rigs that are used mainly for completion work instead of by a drilling rig like the *Deepwater Horizon*. Email correspondence reveals that BP did not initially intend to have the *Deepwater Horizon* install the lock-down sleeve, but then changed course when it was shown that doing so would likely save 5.5 days

---

<sup>173</sup> APM submitted by BP to the MMS (Agency Tracking ID: EWL-APM-123805).

<sup>174</sup> Guide Testimony, October 7, 2010, at 142-43.

<sup>175</sup> BP-HZN-MBI00258507.

of rig time and approximately \$2.2 million.<sup>176</sup> As discussed below, this cost-saving decision may have led to further complications encountered during the temporary abandonment procedures that were underway when the blowout occurred.

### C. *Personnel Changes and Conflicts*

During the drilling of the Macondo well, BP experienced a number of personnel issues related both to a recent reorganization of operational functions and personnel and to personal conflicts among employees with significant responsibilities for drilling operations at Macondo.

In April 2010, BP began to implement a reorganization that involved multiple personnel changes among those with responsibilities for operations at Macondo. The reorganization, among other things: (1) eliminated the wells director position; (2) changed the reporting responsibilities of the wells team leader; and (3) moved an operations engineer under the direct supervision of the drilling engineer team lead. At the time of the blowout, nine BP employees with responsibilities for drilling operations at the Macondo well had been in their current positions for less than six months.<sup>177</sup>

BP witnesses testified that the reorganization did not affect their roles or responsibilities. Information from contemporaneous documents and witness interviews, however, tell a different story. From February through April 2010, a number of different individuals with responsibility for the Macondo drilling operations expressed concerns about the reorganization in general and, in particular, about John Guide's role in light of the reorganization. Guide had previously been at the same level as David Sims, BP drilling and completions operations manager, but after the reorganization he reported to Sims.

Two of Guide's colleagues expressed concerns about his reaction to the reorganization. According to interview notes from BP's investigation, Gregg Walz, a BP drilling engineer team leader, stated that Guide "put Ops first and was concerned about distractions associated with the functional reorganization."<sup>178</sup> Jon Sprague, BP drilling engineering manager for the Gulf of

---

<sup>176</sup> BP-HZN-MBI00097490.

<sup>177</sup> The vice president of drilling and completions; wells manager; drilling engineering manager; drilling and completions operations manager; drilling engineer team lead; drilling engineer; two well site leaders at the *Deepwater Horizon*; and the future well site leader at the *Deepwater Horizon*.

<sup>178</sup> BP-HZN-BLY00061325.

Mexico, testified that he “was concerned that John [Guide] may not be comfortable with the new organization.”<sup>179</sup>

In March 2010, around the time of the second loss of well control at Macondo, there was tension between Sims and Guide. In an email dated March 13, Guide complained to Sims and accused him of making up his mind on corrective actions without listening to input from the well site leaders. In response, Sims said that “we cannot fight about every decision” and that “I will hand this well over to you in the morning and then you will be able to do whatever you want. I would strongly suggest, for everyone’s sake, that you make logical decisions, based on facts, after weighing all the opinions.”<sup>180</sup>

Sims also drafted an email that was addressed to Guide but was never sent. In the email, Sims stated the following about Guide:

- You seem to love being the victim. Everything is someone else’s fault. You criticize nearly everything we do on the rig but don’t seem to realize that you are responsible for everything we do on the rig.
- You will not call the rig in the ops room. You have to sneak out of the room and call them on your cell phone or go back to your office while everyone is in the ops room.
- You can’t sit in a meeting and listen to others’ opinions without arguing with them. You think when somebody has an opinion that they are demanding action. You complain that a bunch of young engineers are throwing out all kinds of wild ideas and that it is driving you crazy. You don’t listen. You key on a random word or phrase and then you fixate on that and don’t hear anything else. You are always defensive and the victim. You seem to not want to make a decision so that you can criticize it later.<sup>181</sup>

During the weeks leading up to the blowout, Guide appeared to have problems handling his responsibilities for operations at Macondo. Notwithstanding the fact that, at the time, he was “very upset” about the March

---

<sup>179</sup> Testimony of Jon Sprague, Joint Investigation Hearing, December 8, 2010, at 246.

<sup>180</sup> BP-HZN-MBI00222521.

<sup>181</sup> BP-HZN-MBI00222540.

8 kick event,<sup>182</sup> Guide did not take steps to ensure that it was fully investigated. According to Sims, Guide was not appropriately engaged in the efforts to deal with the stuck drill pipe after the kick.<sup>183</sup>

The Panel found no evidence that Sims took affirmative or specific steps to address the problems he identified with Guide's performance. Instead, Sims simply made a general plea to Guide, asking him to "make logical decisions, based on facts, after weighing all the opinions."<sup>184</sup>

In addition to the tension between Sims and Guide, there were other organizational challenges that frustrated personnel with responsibilities for Macondo operations. For example, just days before the blowout, Guide said, "[w]ith the separation of engineering and operations I do not know what I can and can't do. The operation is not going to succeed if we continue in this manner."<sup>185</sup> Additionally, Brett Cocales testified about concerns related to his transfer to the engineering department.<sup>186</sup> Cocales testified that his upcoming transfer would move resources from the operations group to the engineering group.

Recognizing the organizational challenges present with the Macondo team, on March 21, 2010, Pat O'Bryan, BP's Vice President of drilling and completions, emailed BP drilling and completions personnel and asked them to be prepared to discuss operations issues, including "the challenges that we've had over the last few weeks." In the email, O'Bryan listed several items he wanted to discuss, and one of the items was "just in time delivery of well plans." Sims' draft email response stated "Nothing is going to change! All leadership, Ops DEs, etc. Lots of stress in the system."<sup>187</sup>

In the weeks leading up to April 20, BP made further changes to the Macondo well team. In early March, BP wells manager Ian Little was out of the office, as was Sims. Little delegated his duties to Guide. Guide's duties at the time included the responsibility for ensuring an investigation into the causes of the March 8 kick was conducted.<sup>188</sup> Cocales assumed Guide's responsibilities

---

<sup>182</sup> BP-HZN-MBI00125458 (post-incident interview notes).

<sup>183</sup> BP-HZN-MBI00222540.

<sup>184</sup> BP-HZN-MBI0022252.

<sup>185</sup> BP-HZN-MBI00255906.

<sup>186</sup> Cocales testimony at 271-72.

<sup>187</sup> BP-HZN-MBI00265306.

<sup>188</sup> Testimony of Ian Little, Joint Investigation Hearing, April 7, 2011, at 38.

when Guide took time off after his father's death.<sup>189</sup> Those responsibilities included investigation of the March 8 kick incident.

On April 6, Keith Daigle, BP well operations advisor, notified Guide that Bob Kaluza would replace Ronnie Sepulvado as one of the two BP well team leaders on the *Deepwater Horizon* so that Sepulvado could attend well control training.<sup>190</sup> Kaluza had four years of deepwater drilling experience but minimal experience with the *Deepwater Horizon* rig.

Meanwhile, the problem of "just in time delivery of well plans," which O'Bryan expressed concerns about, continued. In a post-blowout interview, Gregg Walz stated that, at the time, he "was concerned about last minute changes and he wanted to get work done earlier."<sup>191</sup> On April 12, Sepulvado emailed Brian Morel to ask for temporary abandonment procedures.<sup>192</sup> Morel's subsequent emails revealed that he still had not completed the temporary abandonment procedures and was still not sure whether the Macondo drilling team would set the lock-down sleeve during temporary abandonment.<sup>193</sup>

There was evidence that members of the Macondo team were concerned about operations at Macondo. Morel emailed his wife on April 14 that he had to go offshore to the *Deepwater Horizon* rig because "our normal WSL [well site leader] is heading in and the new guy is good, but not in tune with the well so I need to go out and make sure they follow every step as any deviations could lead to us not getting a good cement job and having to do a lot of remedial operations."<sup>194</sup>

In the days immediately prior to the blowout, the contentious emails between Guide and Sims continued. On April 15, Sims emailed Guide to see if he could meet with him the following morning, and Guide responded by asking Sims if he was going to be fired. In the same email, Sims asked whether he needed to "delegate" Guide's work since Guide had been out of the office and Sims did not know where he was.<sup>195</sup> At this time, the Macondo team was working on critical cementing procedures and needed input from Guide.

---

<sup>189</sup> BP-HZN-MBI00214540.

<sup>190</sup> BP-HZN-MBI00241455.

<sup>191</sup> BP-HZN-BLY00061325.

<sup>192</sup> BP-HZN-MBI00199122.

<sup>193</sup> BP-HZN-MBI00126145; BP-HZN-MBI00126333.

<sup>194</sup> BP-HZN-MBI00329028.

<sup>195</sup> BP-HZN-MBI002543828; BP-HZN-MBI00254858.

On April 17, Guide wrote to Sims:

David, over the past four days there have been so many last minute changes to the operation that the WSL's have finally come to their wits end. The quote is 'flying by the seat of our pants.' More over, we have made a special boat or helicopter run everyday. Everybody wants to do the right thing, but this huge level of paranoia from engineering leadership is driving chaos. This operation is not Thunderhorse. Brian has called me numerous times trying to make sense of all the insanity. Last night's emergency revolved around the 30 bbls of cement spacer behind the top plug and how it would affect any bond logging (I do not agree with putting the spacer above the plug to begin with). This morning Brian called me and asked my advice about exploring opportunities both inside and outside of the company.

What is my authority? With the separation of engineering and operations I do not know what I can and can't do. The operation is not going to succeed if we continue in this manner.<sup>196</sup>

The Panel found no evidence that any of the issues raised by Sims and Guide regarding Guide's performance, the lack of clear authority and reporting lines, and management of changes to the operation were resolved or even meaningfully addressed prior to April 20.

#### ***D. Safety Stand-down***

Events around a proposed so-called safety stand-down on the *Deepwater Horizon* reinforced the fact that there were significant problems with oversight of rig operations and communications. Ronnie Sepulvado, one of the BP well site leaders on the rig at the time, notified Guide on April 10 of a first aid incident aboard the *Deepwater Horizon*, which involved a roustabout sustaining an injury to his left leg from a load being lifted by a crane. Guide and Sims discussed the incident, and Guide suggested a "safety stand down tomorrow so we can get our act together." Sims agreed with the idea of a stand-down, and he added

---

<sup>196</sup> BP-HZN-MBI00255906. The allocation of responsibilities between operations and engineering were outlined in a document that BP referred to as a "RACI" chart. See Appendix K.



“[h]appy to take as much time as you think. 2 first aids and 2 drops in 2 weeks is worth a timeout.”<sup>197</sup>

Following the discussion about the stand-down, Guide sent an email to Paul Johnson, a Transocean rig manager with responsibility for the *Deepwater Horizon*, informing Johnson that it was “probably time to step back for an hour or two. Let’s make sure the crew is engaged.” Johnson agreed and told Guide they would have a safety stand-down with both crews to discuss planning.<sup>198</sup> The Panel found no evidence that indicated a safety stand-down actually occurred outside of the crew’s daily safety meeting, which generally lasted only a few minutes.

---

<sup>197</sup> BP-HZN-MBI00249509.

<sup>198</sup> BP-HZN-MBI00249524.

## VII. Temporary Abandonment of the Macondo Well

At the end of drilling operations, the rig crew needs to secure the well prior to leaving the site. “Temporary abandonment” refers to the process by which the rig crew installs cement plugs in the well and pulls the riser and blowout preventer to the surface to move to another location. Pressure testing (called positive and negative tests) is a key component of temporary abandonment procedures because it seeks to ensure well integrity and that hydrocarbons are not leaking into the well.

### A. *Installing the Lock-Down Sleeve*

BP’s planned temporary abandonment procedures for the Macondo well were not completed until April 12, and subsequently changed a number of times before April 20. The initial plan included the setting of a lock-down sleeve prior to displacing drilling mud from the riser.

Temporary abandonment procedures do not always include installation of a lock-down sleeve. Correspondence from late 2009 and early 2010 shows that BP decided to install the lock-down sleeve as part of its temporary abandonment procedures on the Macondo well to save costs. In January 2010, Merrick Kelley, BP subsea wells team leader, exchanged a number of emails with BP drilling engineer Mark Hafle about the installation of a lock-down sleeve by the *Deepwater Horizon* crew. Kelley calculated that this would save \$2.2 million in incremental costs:<sup>199</sup>

Mark

The 5.5 days assumes that you would have to install the LDS with a rig when the rig is mobilized for the completion. Since we are using HXT now, you would be required to latch BOPs, test and run LDS, then unlatch BOPs, install and test tree, and then latch BOPs back to tree before re-entry for completion can begin. This sequence of activity is typically 7 days whereas if you ran the LDS after production casing you are looking at 1.5 days (39.5 hours is our best run so far). So basically I assumed the actual LDS portion is still the same amount of time, i.e. 1.5 days but you have now used 7 days total (7 days - 1.5 days = 5.5 days extra time and cost) to perform the same operation.

- Incremental cost = 5.5 rig days at \$400,000 = \$2,200,000 - So if you didn't install the LDS after production casing run and did it when the rig came back to start the completion, this is the additional expense associated with this decision.

---

<sup>199</sup> BP-HZN-MBI-00097490.

Hafle discussed this further with David Sims, and they agreed that the *Deepwater Horizon* crew should move forward with the installation of the lock-down sleeve as part of its temporary abandonment procedures.<sup>200</sup> BP chose to do this even though the *Deepwater Horizon* was a rig that conducted exploratory drilling operations – operations that did not typically include the setting of a lock-down sleeve, which was typically done by a rig that specializes in completion operations. Indeed, the Panel concluded that none of the BP personnel on the rig on April 20 had experience setting a lock-down sleeve.<sup>201</sup> Common industry practice is, due to safety concerns, to set the lock-down sleeve in mud prior to displacement and setting of the cement plug. Although the crew displaced the mud, the crew never got to the point of setting the lock-down sleeve.

The Panel found no evidence that BP assessed the risks associated with its decision to set the lock-down sleeve. This decision increased the risk associated with subsequent procedures, including the setting of the surface plug, the displacement, and the negative test sequence. In all likelihood, had the lock-down sleeve been set at a later time, the surface plug would not have been set as deep; the surface plug would have been set sooner; and displacement would not have resulted in a lower pressure differential in the well.

Notwithstanding the fact that the crew was unfamiliar with setting the lock-down sleeve and that this procedure would increase operational risk, there is evidence that members of the crew might have become complacent after drilling was completed. BP contractor Ross Skidmore, when asked about his concerns on the timing of setting the lock-down sleeve, testified that “when you get to that point, everybody goes to the mind set that we're through, this job is done.”<sup>202</sup>

### ***B. Setting the Cement Plug***

On April 16, BP submitted to MMS, and MMS approved, a revised temporary abandonment plan stating that the lock-down sleeve was to be set

---

<sup>200</sup> BP-HZN-MBI100446. One reason to set the lock-down sleeve during temporary abandonment is to enhance safety by protecting the production casing against uplift forces that might occur during production as a result of hydrocarbons flowing up the wellbore. The panel, however, found no evidence that BP decided to set the lock-down sleeve when it did out of safety concerns.

<sup>201</sup> Testimony of Merrick Kelley, Joint Investigation Hearing, August 27, 2010, at 289-90.

<sup>202</sup> Testimony of Ross Skidmore, Joint Investigation Hearing, July 20, 2010, at 263-64.

after the displacement of the mud from the wellbore. The plan also increased the depth of the cement plug to be set in the well as a barrier to flow. BP chose to hang 3,000 feet of drill pipe below the lock-down sleeve to weigh it down.<sup>203</sup> Having chosen to do this, BP believed that it needed to set the cement plug deeper than normal to increase the amount of weight on the lock-down sleeve. The approved plan also called for two negative tests. The first negative test was to be to the wellhead with a seawater gradient on the kill line. The second negative test was to be conducted after displacing with seawater down to 8,367 feet. Further, the approved plan called for the cement plug to be set in seawater after displacement of mud from the wellbore.

BP's temporary abandonment plan also called for the cement plug to be set in seawater after displacement of mud to 3,300 feet below the mud line. This created a risky situation – after displacement of the mud, the well would be in an underbalanced condition and at risk of a well control event. In addition, BP had already eliminated the second cement barrier that would normally be set above the top cement wiper plug. This further increased the well control risks.

### *C. The Use of Lost Circulation Material as Spacer*

BP's plans for displacement of the mud from the riser at the Macondo well called for the use of spacer fluid, which is used to separate the drilling mud from the seawater during displacement. The plans included the use of two different "pills" of spacer. The pills to be used were a blend of leftover lost circulation material that had been mixed on the rig. The lost circulation material (material provided by MI-SWACO with the trade names Form-A-Set and Form-A-Squeeze) had been primarily used to prevent additional lost returns at the well. BP had never used this type of spacer before, and it did not know whether the spacer would be compatible with the synthetic based mud that it was displacing. BP also did not have any information about the long-term stability of the interface between the spacer and the seawater.<sup>204</sup> The Panel found no evidence that BP had provided the rig crew with design specifications for the spacer.

The Panel reviewed evidence, including BP internal emails, that indicated that BP chose to use the lost circulation materials as a spacer to avoid having to dispose of the materials onshore.<sup>205</sup> If the materials were circulated through the

---

<sup>203</sup> Testimony of Ronald Sepulvado, Joint Investigation Hearing, July 20, 2010, at 145.

<sup>204</sup> Testimony of Steve Robinson, Joint Investigation Hearing, December 8, 2010, at 114.

<sup>205</sup> BP-HZN-MBI00262887.

well, the requirement to dispose of the materials onshore could be avoided because the applicable regulations provide an exemption provided for water-based drilling fluids and allow such fluids to be disposed overboard.<sup>206</sup>

BP personnel and MI-SWACO personnel agreed on the use of the lost circulation material “pills” as spacer.<sup>207</sup> On April 20, the rig crew blended the spacer from the lost circulation materials to a 16.0 ppg density. The rig crew pumped 454 barrels of spacer into the well, more than twice as much material as is typically used. The Panel found no evidence that BP considered the possibility that pumping a large amount of 16.0 ppg lost circulation material into the well might risk clogging the choke line or the kill line. Nor did the Panel find evidence that BP discussed this possibility with the rig crew. A clogged choke line or kill line would lead to pressure differentials with the drill pipe and would complicate any negative test procedures using either line.

In its post-blowout investigation, BP concluded that the presence of this spacer allowed for viscous material to be present across the choke and kill lines during the negative test and that this possibly plugged the kill line.<sup>208</sup> This is a possible explanation for the pressure differential between the drill pipe and kill line.

#### ***D. Well Integrity Testing***

##### *1. Negative Pressure Test – Planned Procedures*

A negative pressure test is critical because it tests the integrity of the bottom hole cement job, the wellhead assembly, the casing, and all of the seals in the well. The negative test seeks to create conditions that simulate what will occur after the well is temporarily abandoned. Heavy drilling mud is displaced with spacer fluid and seawater. The displacement invites the well to flow as a way of testing well integrity.<sup>209</sup> The wellbore fluids are replaced such that the wellbore is underbalanced against the formation pressures for the purpose of testing the barriers that are in place. There are a number of alternative ways a rig

---

<sup>206</sup> See 42 U.S.C. 6921-6939f (the Resource Conservation and Recovery Act) and 40 CFR § 261.4(b)(5) (exemption for drilling fluids).

<sup>207</sup> Lindner testimony at 296-298.

<sup>208</sup> Robinson testimony at 96.

<sup>209</sup> Review of Operation Data Preceding Explosion on *Deepwater Horizon* in MC 252, Dr. John Smith, 7/1/10 (Smith Report).

crew can conduct an accurate negative test. In the case of the Macondo well, the barrier being tested was the cement in the shoe track of the wellbore.

BP considered multiple negative test procedures in the days leading up to April 20. Neither BP nor Transocean had pre-existing negative test standards and procedures. As of April 2010, MMS did not require that operators conduct negative tests, and, consequently, did not specify how such tests should be performed.

In an April 18, 2010 email entitled “Negative Test” from Brian Morel to John Guide, Morel briefly explained the negative test to be conducted, stating that the “[p]lan is to do a negative test with base oil on the bottom plug. Then we will displace (a second negative test to greater value will happen) and following that set the cement plug.”<sup>210</sup> Morel then asked Guide:

Are you ok with this, or do you think we should remove the first base oil test and just use the displacement as a negative test (shut down at the end and do a flow test)?... I have got different opinions from everyone on the team. The way we currently have it set up is the standard we have been using, but this one is slightly different because the plug is so deep and base oil doesn’t achieve the full negative load the wellbore will see. Don [Vidrine] and Bob [Kaluza] don’t seem to have strong opinions either way.<sup>211</sup>

Guide responded by saying, “I would use the seawater displacement as the negative test, as you stated, shut down at the end and do a flow test.” Twenty minutes later, Morel replied, without elaboration or any evidence of deliberation, “[d]one.”<sup>212</sup> Neither Guide nor Morel informed the rig crew that these changes greatly increased the risks of a well control event.

Transocean personnel were aware of the importance of conducting a successful negative test. Jimmy Harrell, Transocean offshore installation manager, testified that “[t]he first plan I seen [sic] didn’t have a negative test in it. So I told him [Vidrine] it was my policy to do a negative test before displacing with seawater.”<sup>213</sup>

---

<sup>210</sup> BP considered a number of different negative test procedures in the days leading up to April 20. The different negative test variations that BP considered are detailed in Appendix G.

<sup>211</sup> BP-HZN-MBI-00256247.

<sup>212</sup> *Id.*

<sup>213</sup> Harrell testimony at 26.

When asked how he would typically line up the piping and valve arrangements for conducting a negative test, Harrell described another method for performing a negative test. He explained that “[y]ou do it by leading [bleeding] off back to Halliburton and up your drill pipe. You pump seawater to the end of your tail pipe and all the way back up to above your annular with your spacer...You hold the mud in the riser with the annular closed...You have seawater in the drill pipe and you have seawater in the kill line and either one would be seeing the same pressure...”<sup>214</sup>

Leo Lindner, an employee of MI-SWACO, testified that on the morning of April 20, 2010, he had two separate conversations regarding the negative pressure test, one with Kaluza and one with Morel. Lindner stated:

He [Kaluza] wanted to go over the method by which the rig had been doing its negative test and displacing. I explained – I explained it to him. He seemed satisfied with it. Shortly after that, I was called by Mr. Brian Morel. We had basically the same conversation. He seemed satisfied with it. He informed me they were going to be displacing further down the hole than usual. Usually it's 300 feet below the mud line, but this was going to be at 8,367 feet [3,367 below the mud line]. I left the office and I make my calculations. I type up a displacement procedure.<sup>215</sup>

Lindner’s procedure specifically instructed, as step two, to “[d]isplace choke, kill, and boost lines and close lower valves after each.”<sup>216</sup> The procedure did not instruct the personnel to re-open the choke and kill lines, which would be necessary to perform a negative test on either line. In any event, Lindner presciently noted at the end of the procedure that “[g]ood communication will be necessary to accomplish a successful displacement. If you are not sure, stop and ask.”<sup>217</sup>

The only instruction given to the rig personnel in evaluating the negative test was to monitor the well for no flow. No instructions were given to re-open the choke and kill lines, to monitor drill pipe pressure, or to evaluate and investigate any pressure differentials. Testimony and interview notes from BP

---

<sup>214</sup> Harrell testimony at 33.

<sup>215</sup> Lindner testimony at 272.

<sup>216</sup> BP-HZN-MBI00133083.

<sup>217</sup> *Id.*

personnel revealed that they had an oversimplified view of what constituted a successful negative test – they each believed that they only had to check for flow to evaluate whether a negative test had been successful. Specifically, when asked what a successful negative test was for the Macondo well, Guide said “[a] successful test needs to be run for 30 minutes with no flow from the well.”<sup>218</sup> In response to the same question, Morel said “[n]o flow for 30 minutes,”<sup>219</sup> and Donald Vidrine, a BP well site leader, responded that a successful negative test required “[c]heck[ing] for flow or no-flow.”<sup>220</sup>

Guide and Morel appeared to have agreed upon a simplified approach to the negative test that converted it from the previously-approved multi-step process. When asked in a post-blowout interview why BP made the change from the April 16 approved procedure to the approach reflected in Morel’s April 20 Ops Note, Kaluza responded, “maybe [Guide and Morel were] trying to save time.”<sup>221</sup>

Morel had previously articulated concerns about Kaluza’s ability to execute procedures. Prior to arriving at the *Deepwater Horizon*, Morel stated that Kaluza was “not in tune with the well.” Morel said that he had to “go out [to the *Deepwater Horizon*] and make sure they [the crew under Kaluza] follow every step.”<sup>222</sup> Morel traveled to the *Deepwater Horizon* and was on board on April 20. However, notwithstanding his stated concerns about the cement job, about Kaluza’s level of experience as the well site leader, and about the multiple changes to procedures that increased the risks of a well control event, Morel departed the *Deepwater Horizon* prior to the performance of the critical negative tests.

## 2. Positive Pressure Test Conducted on April 20

Another method of testing well integrity is a positive pressure test, which is a test that is conducted by pumping additional fluid into the well after sealing the blind shear rams. The rig crew then monitors the well to determine whether the pressures in the well remain static. As described previously, the *Deepwater Horizon* crew performed a 2,500 psi positive pressure test between 10:30 a.m. and

---

<sup>218</sup> BP-HZN-BLY00124455.

<sup>219</sup> BP-HZN-MBI00021336.

<sup>220</sup> BP-HZN-MBI00021424.

<sup>221</sup> BP-HZN-MBI000021237.

<sup>222</sup> BP-HZN-MBI00329028.



noon on April 20. The pressures in the well remained constant during testing.<sup>223</sup> Dr. Smith, an expert retained by the JIT to review test data and other information, found the positive pressure test to be acceptable.<sup>224</sup>

### 3. *Negative Tests Conducted on April 20*

Without much time to consider changes in the temporary abandonment procedures, on April 20 the *Deepwater Horizon* crew began work toward conducting the critical negative test to evaluate well integrity. Before starting the test, the crew displaced mud from the wellbore with seawater, which would simulate well conditions after the well had been temporarily abandoned.

The first step of the negative test was to displace the riser boost line, the choke line, and the kill line with seawater.<sup>225</sup> These efforts began at approximately 4:00 p.m. on April 20. Over the next 30 minutes, the crew pumped the 454 bbls of spacer (consisting, as discussed above, of mixed lost circulation materials). Around 4:30 p.m., the crew then pumped approximately 352 barrels of seawater into the wellbore, which took approximately 25 minutes. After pumping the spacer and seawater, seawater should have been located down the workstring and in the wellbore from 8,367 feet to 5,117 feet total depth and the spacer should have been located just above the seawater - from 5,117 feet to 3,707 feet.<sup>226</sup>

After the displacement, the rig crew should have seen a drill pipe pressure of 1,610 psi, based on hydrostatic fluid calculations. However, the electronic data indicates that the drill pipe pressure was 2,339 psi. This reading was more than 700 psi higher than it should have been. If the crew saw this information, they should have taken measure to resolve this anomaly because it may have indicated that the spacer remained below the BOP stack (and could have clogged the choke or kill lines).<sup>227</sup> This problem could have been resolved by continuing the displacement (through the choke line) to ensure that all mud and spacer had been removed from the wellbore below the BOP stack. This method of “cleaning up the well” would not have compromised the function of the spacer because most of the spacer was already in the riser above the BOP stack.<sup>228</sup>

---

<sup>223</sup> Smith Report at 7; *Deepwater Horizon* IADC Daily Drilling Report, April 20, 2010.

<sup>224</sup> Smith Report at 8.

<sup>225</sup> This first step was different from the first step in the MMS-approved APM.

<sup>226</sup> *Id.* at 9.

<sup>227</sup> *Id.*

<sup>228</sup> *Id.* at 18-19.

There is no evidence that the rig crew detected or attempted to address this anomaly. Instead, the crew proceeded to attempt to conduct the first negative test. Well data and testimony establish that the rig crew closed the annular around 5:00 p.m. and attempted to conduct a negative test by first bleeding off the drill pipe pressure from 2,324 psi to 1,427 psi.

The rig crew then opened the kill line valve, presumably to try to balance the kill line and drill pipe pressure. As the kill line pressure fell to 0 psi, the drill pipe pressure remained at 458 psi, thus indicating that the crew may not have fully displaced the spacer from below the BOP stack. At approximately 5:05 p.m., the crew shut in the drill pipe, and concurrently the drill pipe pressure increased. The increase in drill pipe pressure is evidence of an unsuccessful negative test and showed that the well was possibly flowing. In addition, the fact that the choke pressure remained less than 0 psi shows that the negative test was likely either unsuccessful or, at the very least, inconclusive.<sup>229</sup> At 5:25 p.m. the negative test concluded.

Some time between 5:17 p.m. and 5:27 p.m., Jimmy Harrell (Transocean), Robert Kaluza (BP), Donald Vidrine (BP) and other members of the drill crew discussed the first negative test. According to Kaluza, this discussion about the pressure on the drill pipe was “long.”<sup>230</sup> Kaluza stated that Jason Anderson, Transocean assistant toolpusher, explained that the pressure was due to a “bladder effect,” and that “this happens every time.” Brian Morel, a BP drilling engineer who had previously raised concerns about Kaluza’s abilities to execute procedures, was not on the rig at the time (he had departed hours earlier) to be consulted on the drill pipe pressure and other anomalies.<sup>231</sup>

In addition, no one involved in this “long” discussion about the negative test consulted any of the executives visiting the rig at the time, even though these BP officials had more than 50 years of drilling experience. At that time, the executives, including David Sims and Pat O’Bryan, were onboard conducting a rig tour and were presumably available for consultation.<sup>232</sup> There is evidence

---

<sup>229</sup> A reading of less than zero PSI suggests instrument error and/or an inaccurate test.

<sup>230</sup> BP-HZN-MBI00021237.

<sup>231</sup> *Id.*

<sup>232</sup> The group included Pat O’Bryan and David Sims from BP and Daun Winslow and Buddy Trahan from Transocean. They planned to discuss a number of items with the rig crew, including (in the eyes of BP and Transocean) the rig’s record of excellent communication and low

that Sims and O'Bryan met with Kaluza at some point to discuss the positive pressure test and how the crew would be lining up for the negative test.<sup>233</sup> But the crew did not consult O'Bryan or Sims about the actual negative test results.<sup>234</sup>

Around 5:30 p.m., after the first unsuccessful negative test, the rig crew began to set up for another negative test, which began by bleeding off the drill pipe and closing an internal valve in the drill pipe for 20 minutes. Once this valve was closed, the crew was no longer capable of monitoring the drill pipe pressure.

Around 6:00 p.m., the crew bled the pressure from the drill pipe to the cementing unit. At that time, the drill pipe was shut in at the cementing unit, and the pressure on the drill pipe increased to 1,400 psi after 30 minutes. As the pressure on the drill pipe increased, the kill line pressure also steadily increased but only to 140 psi. This pressure differential between the drill pipe and the kill line was another indicator that the negative test was not successful.

Around 6:45 p.m., the crew pumped a small amount of fluid into the kill line to make sure it was full for another negative test. At approximately 7:15 p.m., the crew opened the kill line to monitor for pressure/flow consistent with the APM approved by MMS. After approximately 40 minutes of no flow or pressure observed on the kill line, the crew and the BP well site leaders deemed the negative test successful and began operations to complete the displacement of drilling mud with seawater. Notwithstanding multiple anomalies that the crew encountered during the several failed negative test attempts, the drill crew and the BP well site leaders decided not to flush the system and conduct a new negative test.

Testimony from rig personnel involved with the negative test reflects that they believed that they had successfully tested the integrity of the well by checking for flow on the kill line. Kaluza stated that "[i]t was not flowing...Absolutely no flow."<sup>235</sup> Miles Ezell, Transocean senior toolpusher, testified that Jason Anderson told him that "[i]t went good . . . We bled it off. We

---

rate of "days away from work." They also planned to discuss the rig's financial performance (costs compared to AFEs) and ongoing risk and hazard recognition. See BP-HZN-MBI129014.

<sup>233</sup> Testimony of Patrick O'Bryan, Joint Investigation Hearing, August 26, 2010, at 360, 374; Sims testimony, May 29 2010, at 178.

<sup>234</sup> O'Bryan testimony at 443; Sims testimony, May 29, 2010, at 179.

<sup>235</sup> BP-HZN-MBI00021264.



Around 8:52 p.m. on April 20, about an hour after the second negative test, Donald Vidrine (who was on the rig) called Mark Hafle (who was at BP's Houston offices) to talk about whether to test the surface plug using a pressure test or a weight test. During the conversation, Vidrine also talked to Hafle about the negative tests that the rig crew had just conducted. Vidrine told Hafle that the crew observed zero pressure on the kill line, but there was pressure on the drill pipe. Hafle responded that a successful negative test could not result in pressure on the drill pipe and zero pressure on the kill line. He told Vidrine to consider whether pressure was trapped in the line or perhaps a valve was not properly lined up. Vidrine reported to Hafle that he was fully satisfied that the rig crew had performed a successful negative test.<sup>240</sup>

At the time of the conversation with Vidrine, Hafle was in his office, where he could access real-time data at any time through a system called Insite Anywhere. Indeed, Hafle logged on to the Insite Anywhere database at 1:25:39 p.m. on April 20 and accessed Macondo well information via at 4:13:58 p.m.<sup>241</sup> The file he accessed was "Cementing XY Time Log", and he remained logged into the system (Insite Anywhere) until 5:27:35 p.m.<sup>242</sup> (Refer to Figure 9 – Insite Anywhere Access Log for April 20, 2010). However, Hafle chose not to access available real-time data to help interpret the negative test results. Instead, Hafle apparently accepted Vidrine's explanation without reviewing data from the well on the anomalous negative tests. The Panel found evidence that Hafle remained at the office on April 20 until about 10:00 p.m. CST, which was just after the discussion with Vidrine. After the blowout, he sent an email to himself detailing his activities that day.<sup>243</sup>

---

<sup>240</sup> BP-HZN-BLY00125475.

<sup>241</sup> Insite Anywhere is a database owned by Halliburton, accessible by BP personnel.

<sup>242</sup> HAL 50546.

<sup>243</sup> BP-HZN-MBI00327757.

Supplemental Insite Anywhere Access Log for Deepwater Horizon/MC 252 Macondo  
In Response to CG Subpoena of 10.21.2010

| Time Log   | User Name          | System | Action |
|--|--------------------|--------|--------|
| 04-20-2010 07:51:45 AM Central Daylight Time [GMT-06:00] | David Phillips     | System | Logout |
| 04-20-2010 08:12:19 AM Central Daylight Time [GMT-06:00] | Clare Liwag        | System | Login  |
| 04-20-2010 08:30:26 AM Central Daylight Time [GMT-06:00] | Mark Hafle         | System | Login  |
| 04-20-2010 08:37:52 AM Central Daylight Time [GMT-06:00] | Greg Navarette     | System | Login  |
| 04-20-2010 09:08:03 AM Central Daylight Time [GMT-06:00] | Brandon Miller     | System | Logout |
| 04-20-2010 09:08:41 AM Central Daylight Time [GMT-06:00] | Brandon Miller     | System | Login  |
| 04-20-2010 09:30:40 AM Central Daylight Time [GMT-06:00] | Brandon Miller     | System | Login  |
| 04-20-2010 09:42:33 AM Central Daylight Time [GMT-06:00] | David Phillips     | System | Login  |
| 04-20-2010 09:43:47 AM Central Daylight Time [GMT-06:00] | Christopher Ramsay | System | Login  |
| 04-20-2010 09:52:50 AM Central Daylight Time [GMT-06:00] | David Phillips     | System | Logout |
| 04-20-2010 10:01:27 AM Central Daylight Time [GMT-06:00] | Mark Hafle         | System | Logout |
| 04-20-2010 10:15:50 AM Central Daylight Time [GMT-06:00] | Preeti Paikattu    | System | Logout |
| 04-20-2010 10:37:45 AM Central Daylight Time [GMT-06:00] | David Phillips     | System | Login  |
| 04-20-2010 10:40:19 AM Central Daylight Time [GMT-06:00] | John Guide         | System | Logout |
| 04-20-2010 10:57:54 AM Central Daylight Time [GMT-06:00] | David Phillips     | System | Logout |
| 04-20-2010 11:15:11 AM Central Daylight Time [GMT-06:00] | David Phillips     | System | Login  |
| 04-20-2010 12:47:26 PM Central Daylight Time [GMT-06:00] | Preeti Paikattu    | System | Login  |
| 04-20-2010 13:25:39 PM Central Daylight Time [GMT-06:00] | Mark Hafle         | System | Login  |
| 04-20-2010 13:57:15 PM Central Daylight Time [GMT-06:00] | Greg Navarette     | System | Logout |
| 04-20-2010 15:01:49 PM Central Daylight Time [GMT-06:00] | Brandon Miller     | System | Logout |
| 04-20-2010 15:01:49 PM Central Daylight Time [GMT-06:00] | Brandon Miller     | System | Logout |
| 04-20-2010 15:11:01 PM Central Daylight Time [GMT-06:00] | Derek Boody        | System | Login  |
| 04-20-2010 15:37:36 PM Central Daylight Time [GMT-06:00] | David Phillips     | System | Logout |
| 04-20-2010 16:01:43 PM Central Daylight Time [GMT-06:00] | Parker Hooks       | System | Login  |
| 04-20-2010 16:50:25 PM Central Daylight Time [GMT-06:00] | Clare Liwag        | System | Logout |
| 04-20-2010 16:59:44 PM Central Daylight Time [GMT-06:00] | Christopher Ramsay | System | Logout |
| 04-20-2010 16:59:44 PM Central Daylight Time [GMT-06:00] | Christopher Ramsay | System | Logout |
| 04-20-2010 17:19:50 PM Central Daylight Time [GMT-06:00] | Parker Hooks       | System | Logout |
| 04-20-2010 17:27:35 PM Central Daylight Time [GMT-06:00] | Mark Hafle         | System | Logout |
| 04-20-2010 18:17:10 PM Central Daylight Time [GMT-06:00] | Jaime Diaz         | System | Login  |
| 04-20-2010 18:56:21 PM Central Daylight Time [GMT-06:00] | Derek Boody        | System | Logout |
| 04-20-2010 22:46:16 PM Central Daylight Time [GMT-06:00] | Phoeun Pha         | System | Login  |

Figure 9 - Insite Anywhere Access Log for April 20, 2010

## VIII. Kick Detection and Rig Response

A kick during drilling operations is the unwanted influx of formation fluids, such as hydrocarbons, into the wellbore. An undetected kick can lead to a loss of well control. As stated by Steve Robinson, BP vice president of wells in Alaska, “[t]he key to well control is early detection. It’s getting it shut in quickly.”<sup>244</sup> Monitoring a well for kicks involves observation of a number of indicators and a constant awareness of well conditions.

### A. Kick Detection Methods and Responsibilities

Certain rig personnel, including the driller, assistant driller and mudloggers have specific responsibilities for monitoring the well to detect kicks, among other things.<sup>245</sup> BP’s well control manual provides that the well site leader is responsible for developing, monitoring, and supervising well control procedures. The company drilling engineer is responsible for providing technical support to the wellsite leader. The senior contractor representative has overall responsibility for actions taken on the rig. The contractor toolpusher has overall responsibility for implementing the well control operation and for ensuring that the driller and the drill crew are correctly deployed during the well control operation.<sup>246</sup>

Personnel responsible for well monitoring use a number of methods to determine whether the well is stable. One method is monitoring pit gain, which involves tracking fluid gains in the pits that might indicate flow from the well. Another method is the analysis of flow-out versus flow-in data – which should be equal if the well is stable. As discussed by Dr. John Smith in his report, these two methods – pit gain and comparison of flow-in to flow-out – are critical to effective well monitoring.<sup>247</sup> In addition, other data (including drill pipe pressure changes and gas content information) can also indicate if a well is flowing. A warning from any of these indicators should prompt personnel to stop circulating fluid and to perform a flow check. If flow continues, the well should be shut in using the BOP.<sup>248</sup>

---

<sup>244</sup> Robinson testimony at 44.

<sup>245</sup> Transocean Well Control Manual, TRN-USCG\_MMS00043810.

<sup>246</sup> BP-HZN-MBI00000001.

<sup>247</sup> Smith Report at 21.

<sup>248</sup> *Id.* at 22; See API RP 59; IADC Deepwater Well Control Guidelines.

Because of the importance of kick detection, the members of the rig crew should be in constant communication with one another about possible kick indications, or any other critical observations based on well-monitoring. On the *Deepwater Horizon*, the well site leader was responsible for overseeing all well operations, including well monitoring. The Transocean toolpusher and senior toolpusher oversaw the drilling personnel and should be aware of rig operations that might affect the crew's ability to monitor for kicks. The Transocean offshore installation manager (sometimes referred to as the "OIM") had responsibility for the entire Transocean crew.<sup>249</sup>

Much of well monitoring is done through review of real-time data that rig personnel access on computer consoles. Sperry-Sun sent mudloggers to the *Deepwater Horizon* and also provided real-time data that was accessible to the rig crew. Rig personnel also had access to certain real-time data from Transocean. In addition, video cameras on the rig allowed the crew to monitor certain activities, such as flow being returned to the pits. BP and its operating partners had access to the real-time data through Insite Anywhere, BP's electronic data system that provides real-time flow-in and flow-out data, gas analysis data, stand pipe pump pressures, and other data.

MMS regulations required operators to use the best available and safest technology to monitor and evaluate well conditions and to minimize the potential for a well to flow or kick.<sup>250</sup> The regulations also required the operator to ensure that the toolpusher, operator's representative, or a member of the drilling crew maintains continuous surveillance on the rig floor from the beginning of drilling operations until the well is completed or abandoned, unless they have secured the well with a BOP, bridge plug, cement plug or a packer.

***B. Multiple Simultaneous Operations That Hampered the Crew's Ability to Detect Kicks***

On April 20, after performing the negative pressure tests that were incorrectly interpreted as successful, the rig crew turned to completing the temporary abandonment procedures. The rig crew decided to perform multiple operations over a short period of time, which likely limited their ability to effectively monitor the well. At this time, Bob Kaluza and Donald Vidrine were the BP well site leaders. Brian Morel was the BP drilling engineer, but he had

---

<sup>249</sup> Transocean Well Control Manual, TRN-USCG\_MMS00043810.

<sup>250</sup> 30 CFR § 250.401.



departed the *Deepwater Horizon* prior to the negative tests. Jimmy Harrell was the offshore installation manager and was the senior Transocean representative on duty at the time of the blowout. Miles Ezell, the senior toolpusher, was attending a meeting with visiting executives and assigned Jason Anderson, an assistant toolpusher, to oversee the temporary abandonment work. The Panel found no evidence that Harrell, Ezell or Kaluza were on the rig floor during temporary abandonment operations on the evening of April 20.

The rig crew complicated its well monitoring efforts by displacing mud to two active pits (pits 9 and 10) instead of one. This decision left the rig crew unable to accurately monitor well outflow because when fluid is moved throughout the surface system (to other equipment tanks, filling/draining surface lines, general semi-submersible rig movement, etc.), subtle gains or losses in the trip tanks or pits are more difficult to accurately monitor.

Cathleenia Willis, a Sperry-Sun mudlogger, described the rig activity as follows:

They [the rig crew] were getting prepared to displace and discussed the program. At the safety meeting they said they would displace back to the boat. AD [Assistant Driller] said they would call her because she said she could not monitor displacement back to the boat. When Joe [Keith] came on tower he said he needed to talk to them about displacing to the boat and he was not happy with this.

[Willis] told Joe Keith in handover what was happening and he was not happy about displacement to the boat.<sup>251</sup>

They [rig crew] were filling and dumping the trip tanks between 4:00 p.m. and 6:00 p.m. At 628 strokes AD told her to zero out the strokes, this was during the trip tank transfers. She got the strokes from the choke and kill line and AD said it was okay to zero out the stroke counter.<sup>252</sup>

Transocean's policy, as stated in its Well Control Manual, Section 1.2.2.1, requires "whenever possible, [to] limit circulation to a single active pit. Strictly

---

<sup>251</sup> "Handover" in this context typically refers to the transfer of responsibilities from one person to another.

<sup>252</sup> BP-HZN-MBI00129630.

enforce pit management, and carefully monitor for any discrepancies during trips.”<sup>253</sup>

Joseph Keith, a Sperry-Sun mudlogger, testified that the rig crew was “moving a lot of mud around from different pits, reserve pits, active pits, trip tanks [and] sand traps. They were moving a lot of mud around.”<sup>254</sup> Keith testified that he was concerned about this because he “couldn’t really monitor the volumes in the pits correctly.”<sup>255</sup> Keith also testified that the activities occurring onboard the *Deepwater Horizon* were not consistent with Transocean’s kick prevention procedures.<sup>256</sup> Nevertheless, at no point prior to the blowout, did Keith issue a stop-work order because, according to his testimony, he “just didn’t think of it at the time.”<sup>257</sup> Keith testified, however, that the high level of mud-moving activities should have resulted in a stop-work order from someone on the rig.<sup>258</sup>

Dr. Smith analyzed available data and, in his report, detailed what Keith and the rest of the crew would have observed had they properly monitored the well. Just after 8:00 p.m., an increase of main pit volume by 500 barrels, likely the result of the transfer of seawater into the main pit, precluded the crew from using pit gain as a monitoring tool. According to Dr. Smith, not having this tool available complicated kick detection efforts and was not consistent with proper pit management and monitoring.<sup>259</sup>

Dr. Smith concluded that the crew could not properly monitor the well and detect kicks from 8:38 p.m. to 8:56 p.m. on April 20. During this time, the flow-out was significantly less than the flow-in, in a situation where lost returns were unlikely. At the same time, the trip tank volume was increasing rapidly, and the data showed that there was some volume increase in the main pits. Given the complications created by conducting multiple operations simultaneously, it is unlikely that the crew was able to evaluate these signals that a kick was in progress.<sup>260</sup>

---

<sup>253</sup> TRN-USCG-MMS00043810.

<sup>254</sup> Keith testimony at 39.

<sup>255</sup> *Id.* at 98.

<sup>256</sup> *Id.* at 39.

<sup>257</sup> *Id.* at 81.

<sup>258</sup> *Id.* at 82.

<sup>259</sup> Smith Report at 22.

<sup>260</sup> *Id.*

At 8:58 p.m., flow-out increased significantly and the pit level rose by approximately 100 barrels in 15 minutes. According to Dr. Smith, at this point the crew should have recognized this as a warning sign, stopped circulation and performed a flow check. Dr. Smith stated that “[t]hese failures to respond to kick warning signs are in direct violation of standard industry practice and MMS requirements.” Dr. Smith concluded that the well continued to flow after the pumps were turned off at 9:09 p.m. This continued flow was “a conclusive indicator that a kick [was] in progress, i.e., that formation fluids [were] flowing into the well.”<sup>261</sup>

Keith, a mudlogger with 18 years of experience who had responsibilities for monitoring the well, testified that he went on a five-to-eight-minute break to the coffee shop and the smoking room area at approximately 9:00 p.m. According to Keith’s testimony, after the crew shut down the pumps at 9:09 p.m., he looked at the video feed and did not see any flow.<sup>262</sup> Keith testified that, at this time, he was not aware of increased pressure on the drill pipe, which was another indicator that a kick was in progress.<sup>263</sup>

At 9:10 p.m., having observed none of the several indications that a kick was in progress, the crew rerouted returns from the well overboard, which caused the returns to bypass the Sperry-Sun flow-out meter. This meant that Sperry Sun mudloggers no longer had conventional kick detection methods at its disposal. Dr. Smith observed that “[i]nitiating this action without insuring that the well was under control violates all industry practices and regulatory requirements.”<sup>264</sup>

Keith testified that he did not know the well was flowing until “it sounded like it was raining outside” and he “started smelling gas coming though [his] purge system.”<sup>265</sup>

It is not clear what well control information, if any, the drill crew was monitoring on the evening of April 20. At 9:18 p.m., the driller, Dewey Revette, sent rig crew members to repair a pressure relief valve on one of the pumps. This is significant because it is unlikely that Revette would have sent any crew members to the pump room if he believed that the well was flowing. At

---

<sup>261</sup> *Id.*

<sup>262</sup> Keith testimony at 50, 118-120.

<sup>263</sup> *Id.* at 184.

<sup>264</sup> Smith Report at 23.

<sup>265</sup> Keith testimony at 32.

approximately 9:20 p.m., Jason Anderson, the toolpusher, told Miles Ezell, the senior toolpusher, that the displacement was “going fine...I’ve got this.”<sup>266</sup> Ezell testified that Anderson “had more experience as far as shutting in for kicks than any individual on the *Deepwater Horizon*.”<sup>267</sup> The Panel found evidence that a significant volume of hydrocarbons had already entered the wellbore, but the Panel found no evidence that the Transocean rig crew had any awareness that the well was flowing or experiencing a kick at this time.

### C. *Rig Floor Response*

At approximately 9:30 p.m., Revette identified a pressure difference between the drill pipe and the kill line and shut down the pumps to investigate. The Sperry-Sun data indicated that the drill pipe pressure initially decreased when the pumps shut down. However, the drill pipe pressure then increased by approximately 550 psi during the next five minutes while the kill line pressure remained lower. One crew member testified that the driller and the toolpusher had concerns about this pressure differential.<sup>268</sup>

The rig crew then attempted to bleed off the drill pipe (i.e., open the well) to eliminate the pressure differential, which briefly caused the drill pipe pressure to decrease.<sup>269</sup> Given that the rig crew at this time decided to bleed off the drill pipe pressure, they likely still did not understand that the well had begun to flow. Bleeding off drill pipe pressure during a kick is not an industry-accepted practice.

At 9:38 p.m., the drill pipe pressure began to build back up. Dr. Smith concluded that, at this time, the rig crew routed flow to the trip tank to check whether the well was flowing.<sup>270</sup> At approximately 9:42 p.m., the crew detected flow and diverted the gas to the mud gas separator. At the same moment, or shortly thereafter, the rig crew activated the upper annular preventer, after the mud from the well was already flowing on the rig floor. The Sperry-Sun data indicates the annular preventer was activated at 9:43 p.m., and by 9:47 p.m., the variable bore ram had been activated. By this time, the rig crew knew that a well control event was occurring. The Transocean well control manual provides that the crew should activate the BOP’s blind shear ram (“BSR”) as the last step in

---

<sup>266</sup> Ezell testimony at 282.

<sup>267</sup> *Id.* at 311.

<sup>268</sup> Testimony of David Young, Joint Investigation Hearing, May 27, 2010, at 258-59.

<sup>269</sup> Robinson testimony at 284-85.

<sup>270</sup> Smith Report at 14.

responding to a well control event, but the Panel found no evidence that the rig crew did so at the time.

#### *D. The Use of the Mud Gas Separator*

A mud gas separator is used on a drilling rig to capture and separate gas from the drilling fluid returned from the well. After separation, the mud flows down into the pits and the gas is vented up in the derrick. A mud gas separator is typically used to divert small volumes of hydrocarbons during a kick. If a large flow is sent to the mud gas separator, there is a risk that the vessel will fail and create the possibility of gas ignition. If there is potential for a large flow, the safer option is to divert the flow overboard using one of two diverter lines. The diverter line is typically used during a well control operation when: (a) the gas flow rate is too high for the mud gas separator; (b) hydrates are forming in the gas vent line from the mud gas separator; (c) the gas is found to contain hydrogen sulfide; or (d) the mud system is overloaded.<sup>271</sup>

BP's well control manual states that the mud gas separator should be lined up at all times when a kick is being displaced, but there is a limit to the volume of gas that each mud gas separator can safely handle.<sup>272</sup> Transocean's well control handbook indicates that if gas has migrated or has been circulated above the BOP stack before the well is shut in, the choke manifold and mud gas separator may no longer be available to control the flow rates when the gas in the riser reaches the surface.<sup>273</sup> Both companies recommend using the diverter lines when flow rates are too high for the mud gas separator.

Special precautions and procedures are necessary to avoid the effects of the rapid expansion of gas in the riser, particularly in deepwater operations. According to the Transocean well control manual, there is approximately four times the mass of gas in a 15 barrel influx in 6,000 feet of water as there is in the same influx in 1,500 feet of water.<sup>274</sup> Early recognition of the warning signals and rapid shut-in are the key to effective well control.<sup>275</sup> By taking well control actions quickly, the crew can minimize the amount of formation fluid that enters the wellbore. According to the Transocean well control manual, the rig crew can

---

<sup>271</sup> Hydrogen sulfide is a chemical compound that is highly flammable.

<sup>272</sup> BP-HZN-MBI00000060-61 (pages 1-4-4 and 1-4-5).

<sup>273</sup> BP-HZN-MBI00131628-30 (pages 21 and 23).

<sup>274</sup> *Id.* (Section 8, Subsection 4, page 22 of 28).

<sup>275</sup> *Id.* (Section 3, Subsection 2, page 1 of 2). This is due to gas expanding as it moves towards the surface and as compressive pressure decreases.

calculate the estimated maximum gas and fluid flow rates and wellhead temperature that could result from an uncontrolled flow from the zone of the highest pressure through the open choke manifold.<sup>276</sup> The maximum kick volume (kick tolerance) should also be calculated to ensure that gas liberation at reasonable kill rates will not overload the mud gas separator. Prior to the beginning of drilling operations, specific plans must be made and written instructions given to all personnel concerning non-standard actions/procedures to be performed to prevent or react to any well control problems.<sup>277</sup>

The Transocean well control manual provided that “the choke and kill manifold low-pressure valves must be lined up to direct the flow of the well through the Mud Gas Separator (MGS).”<sup>278</sup> Witness testimony establishes that, at approximately 9:41 p.m., mud from the well began flowing onto the rig floor and the rig crew routed the flow coming from the riser through the diverter system into the mud gas separator.<sup>279</sup> At roughly 9:45 p.m., Stephen Curtis, the assistant driller, called Ezell, the senior toolpusher, to tell him that the well was blowing out, that mud was going into the crown, and that the driller (Anderson) was shutting the well in.<sup>280</sup>

Micah Sandell, a crane operator, testified about what he saw:

After I saw the mud shooting up it was just several seconds and then it just quit. It went down and, at that time, I yelled at my roustabouts to go to the front of the rig. Now, whether they heard my radio I'm not sure, but it was just several seconds after that -- I took a deep breath thinking that 'Oh, they got it under control.' Then all the sudden the degaser is -- mud started coming out of the degaser. And the degaser's on the -- and I'm sure -- I don't know if y'all know it's on the starboard aft of the derrick and it's in a goose neck and it points back down to the deck. And it come out of it so strong and so loud that it just filled up the whole back deck with a gassy smoke and it was loud enough that -- it's like taking an air hose and sticking it to your ear. Then something exploded. I'm not sure what exploded, but just looking at it, it was where the degaser was sitting,

---

<sup>276</sup> *Id.* (Section 8, Subsection 5, page 1 of 17).

<sup>277</sup> Transocean Well Control Manual, TRN-USCG\_MMS00043810.

<sup>278</sup> *Id.* (Section 4, Subsection 1 page 4 of 4).

<sup>279</sup> Testimony of Micah Sandell, Joint Investigation Hearing, May 29, 2010, at 9-12; Young testimony at 264.

<sup>280</sup> Ezell testimony at 283.

it's a big tank and it goes into a pipe. I'm thinking that the tank exploded.<sup>281</sup>

Steven Bertone, the chief engineer on the *Deepwater Horizon*, likened the gas entering the rig to “a freight train coming through my bedroom.”<sup>282</sup> The 12-inch mud gas separator outlet vent and the 6-inch vacuum breaker vent were goose-necked and diverted flow back downward toward the rig, creating a grave risk of explosion directly above the rig.

### *E. Activity on the Bridge*

At approximately 9:48 p.m., a small “jolt” was felt on the bridge of the *Deepwater Horizon*, and simultaneously several of the gas alarms went off.<sup>283</sup> Transocean’s senior dynamic positioning officer, Yancy Keplinger, was on duty at the time, and his responsibilities included monitoring the rig’s dynamic positioning system to ensure the safety of the vessel. Also on duty was Transocean’s dynamic positioning officer, Andrea Fleytas, who assisted Keplinger. Two dynamic positioning officers were on duty at all times – one on the desk where the system is, and one off the desk. At the time of the blowout, Fleytas was on the desk.<sup>284</sup>

Keplinger testified that he believed the initial gas alarms were coming from the shale shaker house, an area of the rig where drilled solids are removed from the mud.<sup>285</sup> Fleytas also testified that the gas alarm for the shale shaker house went off first, followed by the alarm for the drill floor.<sup>286</sup> According to Fleytas, the gas alarms illuminated in magenta, which reflects the highest level of gas concentration. Subsequently, approximately 20 or more magenta gas alarms illuminated, indicating the highest amount of combustible gas the sensors could detect.<sup>287</sup>

Keplinger testified that he went to the video monitor on the bridge (camera 6), which was focused in the starboard aft direction and saw large quantities of mud being ejected, but could not tell whether the mud was coming

---

<sup>281</sup> Sandell testimony at 10-11.

<sup>282</sup> Testimony of Stephen Bertone, Joint Investigation Hearing, July 19, 2010, at 34.

<sup>283</sup> Testimony of Andrea Fleytas, Joint Investigation Hearing, October 5, 2010, at 13.

<sup>284</sup> Testimony of Yancy Keplinger, Joint Investigation Hearing, October 5, 2010, at 128-129.

<sup>285</sup> *Id.* at 151.

<sup>286</sup> Fleytas testimony at 13.

<sup>287</sup> *Id.* at 18, 54-55.

from the diverter or another source.<sup>288</sup> Shortly afterwards, Fleytas received a call from the drill floor, and someone on the rig crew informed her that they had a “well control situation.”<sup>289</sup> Fleytas testified that she received a phone call from someone in the engine control room, and she informed him that the rig was in a well control situation.<sup>290</sup> After the initial explosion, the camera monitors showed flames on the drill floor and a number of additional gas alarms went off. During the call, Fleytas did not inform personnel in the engine control room of the gases in their immediate vicinity.<sup>291</sup>

At approximately 10:00 p.m., the general alarm and the fire alarm on the *Deepwater Horizon* sounded. Keplinger made an announcement over the public address system, instructing the crew to gather at emergency stations and stating, “[t]his is not a drill.”<sup>292</sup> The general alarm on the *Deepwater Horizon* was configured to be a manually-operated system. Mike Williams, the chief electronics technician on the *Deepwater Horizon*, testified that Transocean had set the gas detectors in “inhibited” mode and that this was standard practice.<sup>293</sup> In the inhibited mode, the multiple magenta gas alarms were not set to automatically trigger the general alarm and therefore, there was no alarm configured to immediately warn personnel in the pump room of the urgent need to go to emergency stations.

Fleytas activated the general alarm, but only after the explosion and after talking to the crew on the rig floor and the engine control room and responding to the gas alarms.<sup>294</sup> Fleytas testified that she had never received training on how to respond to multiple high gas concentration alarms going off in multiple areas on the *Deepwater Horizon*.<sup>295</sup>

#### F. *Emergency Disconnect System*

The emergency disconnect system activates the blind shear rams on the BOP stack and disconnects the riser, allowing the rig to move off of the well. The emergency disconnect system is manually initiated but, once activated, performs the various disconnect functions in an automatic sequence.

---

<sup>288</sup> Keplinger testimony at 150.

<sup>289</sup> Fleytas testimony at 13.

<sup>290</sup> *Id.* at 13-14.

<sup>291</sup> *Id.* at 40.

<sup>292</sup> Keplinger testimony at 152. This is typically referred to as “mustering.”

<sup>293</sup> Williams testimony at 30-34.

<sup>294</sup> Fleytas testimony, at 13-14.



Transocean's *Deepwater Horizon* emergency response manual provides guidance for when to activate the emergency disconnect system. The Transocean well control manual outlines the different alert levels that reflect the dynamic positioning status of the rig. The "green" level means that the dynamic positioning systems is functioning in normal operations; the "yellow" level means the station-keeping ability (the ability to keep the MODU on position) is deteriorating and that preparations to disconnect should begin; and the "red" level signals that disconnection is necessary due to continuing deterioration of station-keeping abilities. Transocean's manual states that there is redundant communication in the driller's console and on the bridge to ensure that the driller and crew on the bridge can communicate in the case of any emergency.<sup>296</sup>

Transocean's well control emergency response manual requires drill crews to discuss possible emergency disconnect actions. The manual does not provide the rig's master with defined emergency disconnect responsibilities.<sup>297</sup> The drilling crew, not the master, will typically be in the best position to evaluate possible emergency disconnect actions in a drilling-related emergency. An expert retained by the JIT, Captain Carl Smith, testified that, as a master, he would "rely on the experience of the people on the drill floor" to determine when to initiate emergency disconnect actions.<sup>298</sup>

The Panel found no evidence that there was any attempt to activate the blind shear rams or the emergency disconnect system from the driller's panel. Chris Pleasant, the Transocean subsea engineer, attempted to initiate emergency disconnect actions from the bridge and said, "everything in the panel did like it was supposed to at the panel...I had no hydraulics."<sup>299</sup> Pleasant said that the panel went through its sequence after the explosions, but the rig was unable to disconnect the riser and lower marine riser package from the BOP stack.

---

<sup>296</sup> Transocean Well Control Manual, TRN-USCG\_MMS00043810.

<sup>297</sup> Transocean Well Control Manual, TRN-USCG\_MMS00043810.

<sup>298</sup> Testimony of Carl Smith, Joint Investigation Hearing, October 8, 2010, at 21.

<sup>299</sup> Pleasant testimony at 123.

## IX. Conclusions on Temporary Abandonment, Kick Detection, and the Emergency Response

### A. Kick Detection and Response Failure Cause

At approximately 9:42 p.m., the crew detected flow and diverted the gas influx from the well to the mud gas separator in accordance with the Transocean well control manual. Shortly thereafter, the rig crew activated the upper annular preventers and the upper variable bore ram, after mud ejected from the well was already on the rig floor. **The failure of the *Deepwater Horizon* crew (including BP, Transocean, and Sperry-Sun personnel) to detect the influx of hydrocarbons until hydrocarbons were above the BOP stack was a cause of the well control failure.**

BP's negative test procedures instructed personnel to monitor the well for no flow and no pressure on the kill line. According to personnel monitoring the well, the well was not flowing for 30 minutes and there was no pressure on the kill line. But anomalies present during the negative tests, such as the presence of drill pipe pressure when the kill line pressure was zero, should have prompted the rig crew to investigate the results further. **The *Deepwater Horizon* crew's (BP and Transocean) collective misinterpretation of the negative tests was a cause of the well control failure.**

### B. Kick Detection Failure Contributing Causes

Pit volume (flow-out) data is more accurate measure of flow than calculating volume from pump output strokes and efficiency (flow-in) and is the preferred method for measuring flow. During critical cement testing, the crew was using active pits number 9 and number 10 to transfer fluids to other pits, while at the same time transferring fluids from the rig to the *Damon Bankston*. Due to the activities onboard the *Deepwater Horizon*, the mudloggers were concentrating on the flow-out and flow-in meters. **The *Deepwater Horizon* crew's inability to accurately monitor pit levels while conducting simultaneous operations during the critical negative test was a contributing cause of the kick detection failure.**

### C. *Kick Detection Failure Possible Contributing Causes*

On March 8, 2010, the *Deepwater Horizon* crew experienced a well control event that went undetected for 30 minutes. Ten of the eleven individuals on duty on March 8 during the undetected kick and well control event were also on duty during the April 20 blowout. According to John Guide, Transocean rig management personnel admitted to him that those individuals involved with the March 8 incident had “screwed up by not catching” the kick. Although BP has internal requirements to conduct investigations into all drilling incidents, BP did not do so for the March 8 incident. **BP’s failure to perform an incident investigation into the March 8, 2010 well control event and delayed kick detection was a possible contributing cause to the April 20, 2010 kick detection failure.**

The Panel found no evidence that, during cement pumping, BP shared information with either the *Deepwater Horizon* rig personnel or Transocean shore-based employees about the increased risks associated with the Macondo production casing cement operations, such as, the decision not to include a second cement barrier above the wiper plug and the anomalies encountered during cement pumping. **BP’s failure to inform the parties operating on its behalf of all known risks associated with the Macondo well production casing cement job was a possible contributing cause of the kick detection failure.**

BP decided to combine two lost circulation material pills, and use this combined material as a spacer in the Macondo well. The presence of this spacer allowed viscous material to be across the choke and kill lines during the negative test and possibly plugged the kill line. If the kill line was plugged, it could have led to the pressure differential between the drill pipe and kill line. **BP’s use of the lost circulation material pills as a spacer in the Macondo well likely affected the crew’s ability to conduct an accurate negative test on the kill line and was a possible contributing cause of the kick detection failure.**

John Guide, the BP well team leader, believed that the *Deepwater Horizon* crew had become “too comfortable” because of its good track record for drilling difficult wells. Ross Skidmore, a BP contractor on the rig on April 20, testified that the crew became complacent after completing drilling because “when you get to that point, everybody goes to the mindset that we’re through, this job is done.” The complacency on the *Deepwater Horizon* could be attributable to the crew not having access to all of the well data (OptiCem reports) available to BP personnel onshore and the well site leaders on the rig. **The overall complacency**

**of the *Deepwater Horizon* crew was a possible contributing cause of the kick detection failure.**

BP drilling engineer, Mark Hafle, allowed the temporary abandonment operations on the *Deepwater Horizon* to proceed even though he told Donald Vidrine, the *Deepwater Horizon* well site leader, that “you can’t have pressure on the drill pipe and zero pressure on the kill line in a [negative] test that is properly lined up.” Furthermore, Hafle did nothing to investigate or resolve the pressure differential issue even though he remained in BP’s office until 10:00 p.m. the evening of April 20 and had access to real-time well data (which he logged out of at 5:27:35 p.m.). **Hafle’s failure to investigate or resolve the negative test anomalies noted by Vidrine was a possible contributing cause of the kick detection failure.**

Patrick O’Bryan, vice president of drilling and completions, and David Sims, drilling and completions operations manager, were both onboard the *Deepwater Horizon* during the negative test on April 20. Between the two managers, they possessed approximately 50 years of drilling experience. Neither Vidrine nor Robert Kaluza consulted with their managers about the negative tests, their interpretation, or any other anomalies that occurred on the evening of April 20. Further, Hafle warned Vidrine that there might have been a problem with the negative test. **The failure of the well site leaders to communicate well-related issues with the managers onboard the *Deepwater Horizon* was a possible contributing cause of the kick detection failure.**

The Panel identified five negative test procedures that BP developed between April 12 and April 20. In addition, Leo Lindner of MI-SWACO developed a negative test, and the rig crew performed a negative test through the drill pipe. Also, on April 17, Guide sent an email to Sims stating that there “had been so many last minute changes to the operation that the WSL’s have finally come to their wits end. The quote is ‘flying by the seat of our pants.’” **BP’s failure to provide complete and final negative test procedures to the rig in a timely fashion was a possible contributing cause of the kick detection failure.**

A 15 bbls influx in 6,000 feet of water contains approximately four times the mass of gas of the same influx in 1,500 feet of water. Early recognition of the warning signals and rapid shut-in are therefore crucial to well control in deep water. Taking action quickly minimizes the amount of formation fluid that enters the wellbore. The rig crew first observed the drill pipe pressure anomalies

at about 5:52 p.m. and attempted to bleed-off the drill pipe pressure. After three unsuccessful attempts, the crew eventually justified the pressure as a “bladder effect.” The rig crew did not realize the well was flowing until mud was discharging onto the rig floor. **The *Deepwater Horizon* crew’s hesitation to shut-in the BOP immediately was a possible contributing cause of the kick detection failure.**

The MMS-approved APM called for two negative tests. This would allow for the greater opportunity to detect hydrocarbon influx in a staged test since the first test would have been to the wellhead and the second test would have been to the depth of 8,367 feet. **BP’s failure to conduct the first of the two negative tests was a possible contributing cause of the kick detection failure.**

When the *Deepwater Horizon* crew resumed pumping the returns overboard at 9:15 p.m., the flow bypassed the Sperry-Sun meter due to its downstream location off the flow return trough. Consequently flow-out data could not be adequately monitored by personnel, such as the Sperry-Sun mudloggers, who were responsible for monitoring these data. **The rig crew’s decision to bypass the Sperry-Sun flow meter while pumping the spacer overboard was a possible contributing cause of the kick detection failure.**

Well control training historically has not addressed situations, such as conducting a negative test in that one is “inviting” a well control event to occur. Additionally, displacement operations that put the well in an underbalanced condition should be closely monitored throughout displacement operations. **The failure of BP’s and Transocean’s well control training and MMS requirements to address situations, such as negative tests and displacement operations, was a possible contributing cause of the well control failure.**

#### *D. Response Failure Contributing Causes*

The rig crew’s decision to use the mud gas separator instead of the diverter accelerated the likelihood that the gas on the rig would ignite. **The decision to use the mud gas separator during the well control event was a contributing cause of the response failure.**

Once members of the drill crew identified the increase in drill pipe pressure, they checked the well for flow. At approximately 9:42 p.m., the crew detected flow and diverted the gas to the mud gas separator. The rig crew was not able to determine the magnitude of the flow when it made the decision to go

to the mud gas separator. Transocean's well control manual did not clearly state to go to the diverter if the flow event is unknown. **The ambiguity within the Transocean well control manual on when to use the diverter and not the mud gas separator was a contributing cause of the response failure.**

At approximately 9:48 p.m., several of the gas alarms sounded. Within minutes, approximately 20 gas alarms were sounding, the result of extremely high levels of gas concentration. Yancy Keplinger, the senior dynamic positioning officer, went to the video monitor and saw large amounts of mud being ejected. Shortly afterwards, Andrea Fleytas, the dynamic positioning officer, got a call from the rig floor, which informed her that there was a "well control problem." Fleytas told the Panel she received a phone call from the engine room, but she never told the engine room personnel to perform an emergency shutdown. The initial explosion occurred approximately 30 seconds to a minute after the first gas alarm. At approximately 10:00 p.m., the general alarm and fire alarm on the *Deepwater Horizon* sounded and the rig began to list to one side. Only then did Keplinger make an announcement to muster and prepare to evacuate. Personnel were not told to evacuate until approximately twelve minutes after the first gas alarm went off. **The failure of the personnel on the *Deepwater Horizon* bridge monitoring the gas alarms to notify the *Deepwater Horizon* crew in the engine control room about the alarms so that they could take actions to shut down the engines was a contributing cause of the response failure.**

#### *E. Response Failure Possible Contributing Causes*

The crew was unaware of the volume of the hydrocarbon influx associated with the blowout. **The rig floor crew's inability to determine the location of the kick in relation to the BOP stack and the volume of hydrocarbons coming to the rig in a matter of seconds was a possible contributing cause of the response failure.**

The Panel found no evidence that Jason Anderson, Transocean driller, who was identified in the Transocean procedures as the individual who should initiate the emergency disconnect system, attempted to do so once the hydrocarbons were past the stack. There is evidence that the rig crew activated the upper annular and upper variable bore ram when the hydrocarbons were past the stack. There is also evidence that Chris Pleasant, Transocean subsea engineer, attempted to activate the emergency disconnect system some time after the explosions had disabled communications with the BOP stack. **The rig crew's**

**failure to initiate the emergency disconnect system until after the hydrocarbons were past the BOP stack was a possible contributing cause of the response failure.**

The *Deepwater Horizon* operated a manually-functioned general alarm system. If the general alarm of the *Deepwater Horizon* had been set to automatically sound when “high-high” gas alarms sounded in multiple compartments of the rig, personnel in the pump room likely could have moved to a location where their chances of survival were greater. **The “inhibited” general alarm system was a possible contributing cause of the response failure.**

Transocean’s senior dynamic positioning officer and dynamic positioning officer were not trained for the events they faced on the bridge on the evening of April 20, 2010. **Transocean’s failure to train the marine crew to handle serious blowout events was a possible contributing cause in the *Deepwater Horizon* incident.**

## X. Ignition Source(s) and Explosions

Two explosions occurred almost immediately after the blowout when the large gas plume that had developed over the rig came in contact with one or more ignition sources on the rig. The Panel considered the following possible sources of ignition: (1) main engines and engine switch gear rooms; (2) mud gas separator; (3) electrical equipment in hazardous areas; (4) friction and mechanical sources; (5) non-hazardous area sources; and (6) electrostatic discharge.

It is not possible to determine with certainty the source of ignition because much of the physical evidence relevant to making such a determination was lost with the rig or otherwise is not available. Based upon its review of witnesses testimony and other evidence, the Panel concluded that the main engines (and switch gear rooms) and the mud gas separator were the most likely ignition sources.

### A. *Main Engines and Engine Switch Gear Rooms*

#### 1. *Configuration of Engine Rooms on the Rig*

The *Deepwater Horizon* had six engines located on the third deck of the rig. Each engine was in an engine room that was equipped with air intake systems. Each air intake system drew air from vents located in the engine room in which it sat. Each engine room had an engine switch gear room attached to it.

The *Deepwater Horizon's* engine rooms and switch gear rooms were located in "unclassified" areas, which were areas that did not require explosion-proof enclosures, intrinsically-safe equipment, and/or purged and pressurized equipment. The engines and switch gears in the non-classified areas were not designed or tested to ensure that they would not initiate an explosion.

The engines had multiple redundant safety systems and shutdown devices designed to shut down the engines in an over-speed situation. Engine over-speed is a condition where an engine's revolutions per minute ("rpms") exceed their normal operating speed. This condition can occur when combustible gas is drawn into the intake system. To prevent this, the air intake systems included a shut-off device (sometimes referred to as a "rig saver") that



sought to ensure that the engine would not over-speed after ingesting combustible gases.<sup>300</sup>

The design of engine shutdown mechanisms on dynamically-positioned rigs, such as the *Deepwater Horizon*, is different from the shutdown systems in moored or jack-up rigs.<sup>301</sup> Instead of the single top-level shutdown of all engines, a dynamically-positioned rig is typically designed to allow the rig to activate an emergency disconnect system to separate from the wellhead and allow the rig to escape the hazardous area in the event of an uncontrolled blowout or other emergency. This design also allows for continued use of the engines in an emergency such as a fire.<sup>302</sup> Manual activation of the emergency disconnect system, required on a dynamically-positioned rig, can add complexity to a rig crew's response to a well control event and can also create a possible ignition source during the presence of free gas on the rig.

## 2. *Testing of the Over-Speed Devices*

A representative of Wartsila, the manufacturer of the *Deepwater Horizon* engines, told the Panel that all automatic stop devices should be function tested at least once every 1,000 hours of engine operation and that the over-speed trip devices be checked every 2,000 hours.<sup>303</sup> He also stated that the *Deepwater Horizon* engines were not configured to run on natural gas and that if they ingested natural gas they would mechanically fail (but not explode).<sup>304</sup>

The Panel found no evidence establishing whether, and how often, the engine over-speed devices and individual engine components were tested by the American Bureau of Shipping ("ABS"). ABS conducted yearly inspections of the over-speed devices during their continuous machinery surveys. These yearly inspections included an evaluation of approximately 20% of the over-speed devices on the rig, with the goal of inspecting all devices within a 5-year period.

---

<sup>300</sup> KMI\_PI001156 RBS8D. The driller was responsible for shutting in the engine air intake on the *Deepwater Horizon*. The driller's other responsibilities included: drilling the well and knowing the drilling operations; monitoring real time data of the well; insuring the safety of rig floor personnel working in a confined space; investigating well flow issues and responding to well control events; communicating with the Subsea Engineer; and activating the EDS if necessary.

<sup>301</sup> A moored rig is held in place by cables attached to giant anchors; a jackup rig is towed onto location and is supported by mechanical legs lowered to the seafloor.

<sup>302</sup> KMI\_PI001156 RBS8D.

<sup>303</sup> BOEMRE interview of Bob Miller (Wartsila) (November 16, 2010). An "overspeed trip device" is a safety device that is designed to restrict the uncontrolled acceleration of the engine.

<sup>304</sup> *Id.*

Unfortunately, ABS inspectors did not record which devices were tested each year, which meant that there was no way to ensure that different over-speed devices were subject to inspection each year and that each device over time had been inspected.<sup>305</sup>

The *Deepwater Horizon*, as discussed earlier in this Report, was a vessel flagged under the Republic of the Marshall Islands. Foreign-flagged vessels are subject to USCG “Certificate of Compliance” inspections. These inspections do not normally include testing of over-speed devices unless there is some evidence to indicate that they might not function properly. One of the USCG inspectors who conducted the inspection of the *Deepwater Horizon* stated that the engine rooms and all machinery contained therein appeared to be well-maintained. The inspector did not deem it necessary to test the rig’s over-speed devices because: (1) as a foreign-flagged vessel, inspection is not required; and (2) conducting any test of the over-speed device could not be done without interrupting drilling operations.

3. *Evidence Relating to the Engine Rooms as a Potential Ignition Source*

Engines number 3 and number 6 were online at the time of the blowout. The air intakes for engine room 3 were located approximately 60 feet from the rig floor in the center of the main deck.

Personnel on the *Deepwater Horizon* testified about what they saw and heard on April 20 in the immediate vicinity of the engine rooms. Douglas Brown, the chief mechanic on the *Deepwater Horizon*, who was in the engine control room at the time of the blowout, testified:

And right upon that the engines RPM started increasing. I heard them revving up higher and higher and higher. Next I was expecting the engine trips to take over, such as the overspeed, and that did not happen. After that the power went out and I was assuming that was our high-frequency trip and we were put in dark, and right on the end of that was the first explosion.

\* \* \*

---

<sup>305</sup> Testimony of Arinjit Ray, Joint Investigation Hearing, May 26, 2010, at 297.

I'm going to say both of them revved up at the same time, and we had engines 3 and 6 on line at the time. And in my opinion, I'm going to say that Engine 3 most likely blew up, simply because the explosion came from the port side, which Engine 3 was pretty much located right next to the engine control room down one level. And I really can't say which one revved up first, 'cause to me it sounded like both of them did.<sup>306</sup>

Mike Williams, the chief electronics technician, who was in the electronic technician's room at the time of the blowout, testified:

. . . I knew which engines were on line at any given time. I could hear Engine Number 3 start to rev up, and its normal operating RPM's to way above what I ever heard it run before, and its continuously steadily rising, and I knew then that we were - we were having a problem. As I started to push back from my desk, the computer monitor exploded in front of me. All the lights in my shop popped. The light bulbs themselves physically popped. Now I know we're in trouble. I reached down to grab my door, and at the - simultaneously of grabbing the handle, the engine goes to a level that is higher than I can even describe it. It's spinning so fast that it just - It stopped spinning and there's a huge explosion.<sup>307</sup>

Once Williams made it to the bridge, he explained to Captain Kuchta, master of the *Deepwater Horizon*, “[y]ou need to understand. We have no engine control room]. It's gone. It has blown up. Engine Number 3 for sure has blown up.”<sup>308</sup>

Willie Stoner, a motorman, who was in the engine control room, testified:

As it was roaring, the Number 3 engine you could hear the Number 3 engine, which would be right here (indicating) started revving up. And, as soon as it started revving up, it started a load down change over. In other words, it's supposed to kick off

---

<sup>306</sup> Testimony of Douglas Brown, Joint Investigation Hearing, May 26, 2010 at 93-94, 97.

<sup>307</sup> Williams testimony at 13.

<sup>308</sup> *Id.* at 18.

the line...[a]nd, as soon as it did that, I could see -- well, Doug [Brown] said "Something ain't right." ...And, as he said that, about that -- as soon as he stated that, he turned and came right over to the console just to look at the screen. And, within seconds of that, I saw roughly three, maybe five [emergency shut-downs] on the very bottom of the panel start flashing. I don't know if somebody set them off or if -- That's emergency shut downs. It's supposed to be actually for dampeners and to that effect if there's a fire or something to that effect. Okay. They started flashing, within seconds of that there was a big explosion, a loud "Bang," it got black. The port door on this here side (indicating) blew in. As soon as it blew in within a matter of seconds the starboard side blew in as soon as you heard the second explosion.<sup>309</sup>

Paul Meinhart, a motorman, who was also in the engine control room, testified:

The first explosion I was standing with my back to the port side next to a door. The door on the port side of the engine control room got blow in. So, I believe that it came from the port side of the vessel from where we were at.

\* \* \*

The second explosion at that time I had just moved over, but I still had my back to the port side. But there's another door coming from the center of the rig. During the second explosion that door got blown open.<sup>310</sup>

The above witness testimony suggests that one or more of the explosions occurred in the vicinity of engines 3 and 6.

### ***B. Mud Gas Separator***

As discussed previously in this Report, immediately following the blowout the rig crew decided to send the hydrocarbon influx to the mud gas

---

<sup>309</sup> *Id.* at 342.

<sup>310</sup> Testimony of Paul Meinhart, Joint Investigation Hearing, May 29, 2010 at 32-33.

separator, which could have caused the catastrophic failure of the device.<sup>311</sup> The Panel found evidence that the configuration of the mud gas separator system directed the venting gas back towards the rig floor. A 12-inch device called a mud gas separator outlet vent was located at the top of the derrick and was configured so that the pipe ran back toward the rig. This “gooseneck” piping directed any venting gas and fluids back down to the rig floor. Another device called a vacuum breaker was configured in a similar manner, but located at approximately one-third of the height of the derrick.

A number of individuals onboard the *Deepwater Horizon* at the time of the blowout testified about what they saw in the vicinity of the mud gas separator.

Micah Sandell, a crane operator, who was in the port aft deck gantry crane, testified that “all the sudden the degasser is – mud started coming out of the degasser” and “it [came] out of it so strong and so loud that it just filled up the whole back deck with a gassy smoke and it was loud enough that - it's like taking an air hose and sticking it to your ear. Then something exploded.”<sup>312</sup>

Paul Erickson, a dynamic positioning officer, who was on the bridge of the *Damon Bankston*, testified:

Shortly after 9:30, I observed a cascade of liquid coming out of the rig, the area of the drilling gear.

\* \* \*

Shortly after the – after 9:30, after the, I saw the liquid coming out the bottom of the rig, I heard what I thought at the time was a pressure tank unloading. It's not uncommon to dump the air out of a pressure tank, but it lasted maybe 20, 30 seconds, which was not an unusual occurrence, but I mentally categorized it as an unloading, which was not an exception. In fact, it escaped my mind because it seemed to be one of the fairly routine things to happen.

---

<sup>311</sup> As discussed in the previous section, the mud gas separator is a device used to separate gas from drilling fluid. It is not designed to handle high volume flow. The panel calculated that the possible instantaneous flow rate was approximately 129.6 million cubic feet per day (“MMCFPD”) based on fact that the Sperry-Sun data showed a 150 bbl influx.

<sup>312</sup> Sandell testimony at 10-11. A gantry crane is a large crane that is on a horizontal track and can move across the main deck.

\* \* \*

Shortly after that, I saw an eruption of fluid out of the aft end of the derrick on the main deck of the rig and the Captain had been on the radio to the rig telling them we were being covered with mud and they had responded that they were having a well control problem and shortly after that we were told that we ought get out of the way.

Somewhere in that interval, the eruption of liquid and the aft end of the rig behind the - aft of the derrick,<sup>313</sup> there was a flash of fire and I hollered, "Fire on the rig, fire on the rig," and headed for the general alarm and after that it got pretty chaotic.<sup>314</sup>

Alwin Landry, the captain of the *Damon Bankston*, who was also on the bridge of that vessel, testified:

And he [Erickson] advised me that there was mud or something coming out from under the rig. I started to turn to look and I seen mud falling on the back half of my boat, kind of like a black rain. And I was a little annoyed at first because I thought it might have been a ruptured hose through a process up there. So when I seen the magnitude of the mud coming down we instinctively closed the wheelhouse doors. I went to the port side and I looked out up at the derrick and that's when I seen the mud coming out the top of the derrick. I came back to the center of the ship, established contact with the Horizon and asked them what was going on. "I'm getting mud on me." I was advised that they was having trouble with the well. Momentarily after that, another voice came over the radio asking me to go to 500 meter standby. I advised them I still had a transfer hose onboard. There was a pause and a response and then shortly after that, the first explosion at the rig occurred.

\* \* \*

At that point, my focus was on top the derrick. At that point, it was my concern for my crew, also, because I knew it was coming up aft deck and I couldn't see right behind my cabin on the lower levels. So simultaneously

---

<sup>313</sup> The location described is the same area where the air-intakes for engine rooms 3 and 4 were located.

<sup>314</sup> Testimony of Paul Erickson, Joint Investigation Hearing, May 11, 2010, at 228-32.

working radios and I talked to the bridge. I informed my guys to come inside away from the deck area. So my focus was there and it wasn't nowhere else on the rig until I felt and heard the explosion off the port side there.<sup>315</sup>

These witnesses testified that they saw mud flowing and possibly a “gassy smoke” in the vicinity of the air intake for engine room 3 and the mud gas separator prior to the explosions. This suggests that engine room 3 or the mud gas separator was a possible ignition source.

### C. *Other Possible Ignition Sources*

#### 1. *Electrical Equipment in Hazardous Areas*

Hazardous area classification is based on the identification of areas or zones according to the likelihood of the presence of sensitive flammable gas or vapor concentrations. The most likely location for unguarded electrical equipment to ignite flammable gas is the area on or near the drill floor. Transocean classified the drill floor on the *Deepwater Horizon* as a Zone 2 hazardous area. Zone 2 denotes an area where explosive gas/air mixtures are not likely to occur, but if they do occur, they are expected to be present for only a short period of time.

Electrical equipment in designated hazardous areas must be subject to the following safeguards: (1) explosion-proof enclosures; (2) intrinsically-safe equipment (does not have sufficient energy to ignite flammable gases); and (3) purged and pressurized equipment (contained within enclosures supplied with fresh air from a safe location at a pressure higher than the pressure of the surrounding area).

The Panel found no evidence that electrical equipment in designated hazardous areas was an ignition source. MMS inspectors conducted three inspections while the *Deepwater Horizon* was on location at the Macondo well, and they issued no Incidents of Non-Compliance (“INCs”) following inspection of rig floor electrical equipment. No witness testimony or other evidence identified any failure by Transocean to subject the electric equipment in designated hazardous areas to the appropriate safeguards.

---

<sup>315</sup> Testimony of Alwin Landry, Joint Investigation Hearing, May 11, 2010, at 99-100.

## 2. *Friction and Mechanical Sources*

Mechanical sparks occur when there is excessive friction between metals or extremely hard substances. As the two substances rub against each other, small particles are torn from the surfaces.<sup>316</sup>

At the time of the blowout, the rig floor crew was investigating the drill pipe pressure differential, an activity not likely to cause friction. Chad Murray, chief electrician on the *Deepwater Horizon*, was in the electrical shop on the port side of the third deck. Murray saw others working on the number 2 mud pump prior to the explosion.<sup>317</sup> The electrical shop is approximately 50 feet away from the number 2 mud pump. None of the individuals working on the number 2 mud pump survived the explosion. The Panel believes that it was unlikely that the members of the crew who were working on the number 2 mud pump continued to work as the well blew out and gas rushed onto the rig. If in fact, as the Panel believes, these individuals stopped work immediately, there would have been no mechanical friction ignition source in the area.

## 3. *Other Non-Hazardous Area Sources*

If flammable gases dispersed beyond the hazardous areas on the rig to other deck levels with unclassified equipment, then other ignition sources were possible. The Panel, however, found no evidence that the source of ignition was located in any of the non-hazardous areas of the rig.

## 4. *Electrostatic Discharge*

Electrostatic charge or static electricity occurs in many industrial operations. Static discharges are responsible for many industrial fires and explosions. Hydrocarbon gases are extremely vulnerable to static discharge ignitions that may often be undetectable by human sight or hearing.<sup>318</sup> The Panel

---

<sup>316</sup>For a metal to spark, it must satisfy three conditions. First, the energy that causes particles to be torn free must be sufficient to heat the metal to high temperatures. Softer metals usually deform before they spark. Second, the metal must be able to oxidize and burn easily. Generally, a metal's sparking temperature is the same as its burning temperature. And third, the metal must have a specific heat that allows it to spark. A metal with a low specific heat will reach a higher temperature for the same amount of energy input.

[http://www.firesandexplosions.ca/hazards/ignition\\_sources.php](http://www.firesandexplosions.ca/hazards/ignition_sources.php).

<sup>317</sup> Testimony of Chad Murray, Joint Investigation Hearing, May 27, 2010, at 336.

<sup>318</sup> Static Electricity – Guidance for Plant Engineers, Graham Hearn, 2002.



could not rule out electrostatic discharge as a possible ignition source, but it found no evidence directly supporting this theory.

## XI. Conclusions on Ignition Source and Explosion

The Panel concludes that there were two plausible ignition sources at the time of the blowout: (1) engine rooms number 3 and/or number 6 (and associated electrical switch gear rooms); or (2) the mud gas separator located near the rig floor. The evidence that supports the Panel's conclusion is discussed below.

### A. Ignition Sources

**The most probable ignition source was engine room number 3 and/or number 6.** The conclusion is supported by: (1) witness testimony; (2) the location of the air intakes into the engine rooms; (3) engine and electrical switch-gear rooms that were unclassified areas with numerous potential ignition sources that could initiate an explosion; (4) as a dynamically-positioned rig, the *Deepwater Horizon* may not have been designed to immediately shut-down when high levels of gas are detected; (5) the Panel found no evidence that the over-speed devices properly functioned and found evidence that such devices may not have been inspected.

As mentioned previously in this Report, the hydrocarbon influx quickly overwhelmed the mud gas separator. Witness testimony supports the fact that there was a flash explosion near the air intake of engine room number 3 and the mud gas separator shortly after the gas came onto the rig. **The catastrophic failure of the mud gas separator created a possible ignition source with the gas plume released onto the rig from the well.**

### B. Contributing Causes of the Explosion

The air intake for engine room number 3 is located in the center of the deck just aft of the rig floor, while the air intake of the engine room number 6 is outboard on the starboard side of the rig aft of the rig floor. The Panel concluded that the delayed explosion between engines number 3 and number 6 was due to the difference in the distance between the air intakes and the gas flow. **The location of the air intakes for the engine room number 3 and number 6 was a contributing cause of the *Deepwater Horizon* explosion.**

The Panel found no evidence that the "rig saver" function of the over-speed devices successfully shut down engines 3 and 6. **The failure of the over-**

**speed devices to initiate shut-down of the engines was a contributing cause of the *Deepwater Horizon* explosion.**

The “gooseneck” configuration of the mud gas separator vent allowed for the venting of hydrocarbons back onto the rig. This increased the risk of ignition. **The location and design of the mud gas separator outlet vents was a contributing cause of the *Deepwater Horizon* explosion.**

Prior to the two explosions, approximately 20 gas alarms went off indicating the highest level of gas concentration on the rig. Andrea Fleytas, the dynamic positioning officer, testified that she received a phone call from the engine room, but she never informed them to initiate the emergency shutdown sequence or that there was a well control event. **Fleytas’ failure to instruct the *Deepwater Horizon* engine room crew to initiate the emergency shutdown sequence after receiving 20 gas alarms indicating the highest level of gas concentration was a contributing cause in the *Deepwater Horizon* explosion.**

### *C. Possible Contributing Causes of the Explosion*

Neither the engine room nor the switch-gear room was a classified area. Therefore, the equipment was not required to be explosion-proof or intrinsically safe. Nor is there a requirement that the area be purged or pressurized. **The classification of engine rooms number 3 and number 6 as non-classified areas was a possible contributing cause of the *Deepwater Horizon* explosion.**

The *Deepwater Horizon* had multiple inspections and surveys during the ten-year period it was operating in the Gulf of Mexico. The Panel found no evidence that anyone identified the location of the engine air intakes as a potential safety issue. **The failure to identify the risks associated with locating the air intake of engine room number 3 in close proximity (approximately 60 feet) to the drill floor was a possible contributing cause of the *Deepwater Horizon* explosion.**

The gas sensors in the engine compartment rooms of the *Deepwater Horizon* did not automatically shut down the engines when there were high levels of gas present on the rig. **The absence of emergency shut-down devices that could be automatically triggered in response to high gas levels on the rig was a possible contributing cause of the *Deepwater Horizon* explosion.**

The *Deepwater Horizon* had multiple inspections and surveys that should have included the inspection of the engine overspeed shutdown devices. The panel has been unable to ascertain exactly when each overspeed device was tested. Accordingly, ABS indicated that it inspects 20% each year; however, neither ABS nor Transocean document which devices are tested to ensure that the same device is not tested each year and that all devices get tested within the rotation frequency. **The failure of ABS and Transocean to document which devices are tested to ensure all devices are tested is a possible contributing cause of the DWH explosion.**

The emergency shut-down response on a DP MODU utilizes a different operating philosophy than employed on moored MODUs. Instead of the single top level shutdown of all engines, the DP MODU rig is designed with an emergency disconnect capability from the wellhead in order to escape the hazardous area in the event of an uncontrolled blowout. Based on this mindset, the engines should not be shutdown because of the need for DP power. Even if the process of manual activation is fully understood by those responsible for it on a DP MODU, it adds additional complexity to response of the well control event. Further, the philosophy creates a conflict since the rig needs to maintain power to get off location while maintaining that power creates a possible ignition source during the presence of free gas on the rig. **The DP MODU operating philosophy when considering the performance of an Emergency Shutdown (ESD) is a possible contributing cause in the Deepwater Horizon explosion.**

#### *D. Other Possible Ignition Sources*

##### *1. Electrical Equipment in Hazardous Areas*

The most likely location for the ignition of flammable gas by unguarded electrical equipment would be in the area on or near the drill floor. The *Deepwater Horizon* drill floor required the use of properly maintained and certified explosion-proof, intrinsically-safe, or purged and pressurized equipment, which should have prevented the ignition of flammable gases by any electrical equipment installed in this area. **The Panel found no evidence that the electrical equipment located on or near the drill floor's hazardous area was a cause of the ignition.**

## 2. *Mechanical Sources*

For mechanical sparks resulting from friction to have occurred, there must be movement of equipment. At the time of the blowout no rig floor operations were being conducted outside of the investigation into the drill pipe pressure differential. **The Panel found no evidence that the mechanical equipment on the rig floor was a cause of the ignition.**

## 3. *Other Non-Hazardous Area Sources*

If the flammable gas cloud dispersed beyond the hazardous areas on the rig to other deck locations with unclassified equipment, then those ignition sources could have sparked an explosion. Any unclassified equipment, such as an electrical outlet, would not result in ignition unless a spark was available. Additionally, the electrical equipment located on the weather deck (top deck) is typically sealed against the exposure of the offshore environment. **The Panel found no evidenced that non-hazardous area sources were the cause of the explosion.**

## 4. *Electrostatic Discharge*

Electrostatic charge or static electricity occurs in many industrial operations. Static discharges are responsible for many industrial fires and explosions caused by static electricity. Hydrocarbon gases are extremely vulnerable to static discharge ignitions that may often be undetectable by human sight or hearing. **There Panel found no evidence of electrostatic discharge, but it cannot be ruled out as a possible source of ignition in the explosion.**

## **XII. The *Deepwater Horizon* BOP Stack**

A BOP stack is a series of rams and annulars situated at the top of a well that the rig crew can close if it loses control of formation fluids. BOPs come in a variety of configurations, sizes and pressure ratings. Some BOP components are designed to seal an open wellbore, some are designed to seal around tubular components in the well, some are fitted with hardened steel shearing surfaces to cut through drill pipe or casing, and others are designed to cut through drill pipe and seal the wellbore.

### **A. Design and Configuration**

Cameron manufactured the BOP stack used during drilling operations by the *Deepwater Horizon*. Cameron originally sold the BOP to R&B Falcon, which, as discussed previously, was acquired by Transocean.<sup>319</sup> Cameron delivered the final assembled BOP stack, which weighed approximately 650,000 pounds, to R&B Falcon in April 2000.<sup>320</sup>

R&B Falcon provided Cameron with specifications for required functions and the preferred configuration of the desired BOP stack.<sup>321</sup> David McWhorter, Cameron vice president of engineering and quality, testified that Cameron assembled the stack according to R&B Falcon's design specifications and in compliance with API specifications.<sup>322</sup> McWhorter indicated that Cameron designed and tested its equipment in accordance with API Specification 16A. Cameron does not subject its BOPs to dynamic flow testing, nor is such testing required in API Specification 16A.<sup>323</sup>

The *Deepwater Horizon* BOP assembly consisted of two major sections: the stack and the lower marine riser package (*see* Figure 10). At the time of the blowout, the major components of the *Deepwater Horizon* main stack consisted of the following:

- Wellhead connector, which connected the BOP stack to the Macondo

---

<sup>319</sup> In 1999, when it manufactured the BOP, "Cameron" was the Cameron Division of the Cooper Cameron Corporation.

<sup>320</sup> CAMCG 00002843; TRN-USCG-MMS-00014355.

<sup>321</sup> Cameron Communication to JIT.

<sup>322</sup> Testimony of David McWhorter, Joint Investigation Hearing, April 8, 2011, at 112, 117.

<sup>323</sup> McWhorter testimony at 153. Dynamic flow testing is testing of the BOP stack under conditions that simulate pressures that might be generated by a blowout.

wellhead.

- Two variable bore rams (“VBRs”) designed to seal around several different sizes of drill pipe but do not shear or otherwise affect the drill pipe.
- Test ram (converted VBR), which is an inverted VBR that is designed to only hold pressure from the top down.<sup>324</sup>
- Casing shear designed to cut through drill string or casing. It consisted of a cutting element only, and was not designed to seal.
- Blind shear ram (sometimes referred to as “BSR”) consisting of both a cutting and sealing element and designed to cut the drill pipe and seal the well.
- Choke and kill lines, which are high-pressure pipes that led from an outlet on the BOP stack to the rig pumps.<sup>325</sup> Typically, the choke does not connect to the rig pumps, however, the *Deepwater Horizon* BOP could use the choke and kill lines interchangeably.
- Remotely operated vehicle (“ROV”) panels – operating panels that allow an ROV lowered to the sea floor to activate certain function on the BOP stack.<sup>326</sup>
- Accumulator bottles, which provided hydraulic fluid used to operate the various BOP elements.

At the time of the blowout, the major components of the lower marine riser package consisted of the following:

- Two annulars (upper and lower), which are rubber-metal composite elements capable of closing around the drill pipe to seal the annulus.
- Blue and yellow pods, two redundant control pods used to operate the BOP components.
- Multiplex connector, the point at which the multiplex lines connect to the BOP stack.
- ROV hot stab panels, which are operating panels that allow an ROV lowered to the sea floor to activate certain function on the BOP stack.
- Accumulator bottles, which provided hydraulic fluid used to operate the various BOP elements.

---

<sup>324</sup> BP-HZN-MBI-000136647; BP *Deepwater Horizon* Accident Investigation Report, 172.

<sup>325</sup> During well control operations, rig crews pump kill fluid through the drill string and annular fluid is removed from the well using the choke line.

<sup>326</sup> To “hot stab” is to insert an ROV’s robotic arm into a hydraulic port on the BOP stack to pump hydraulic fluid into the BOP ram closing system.

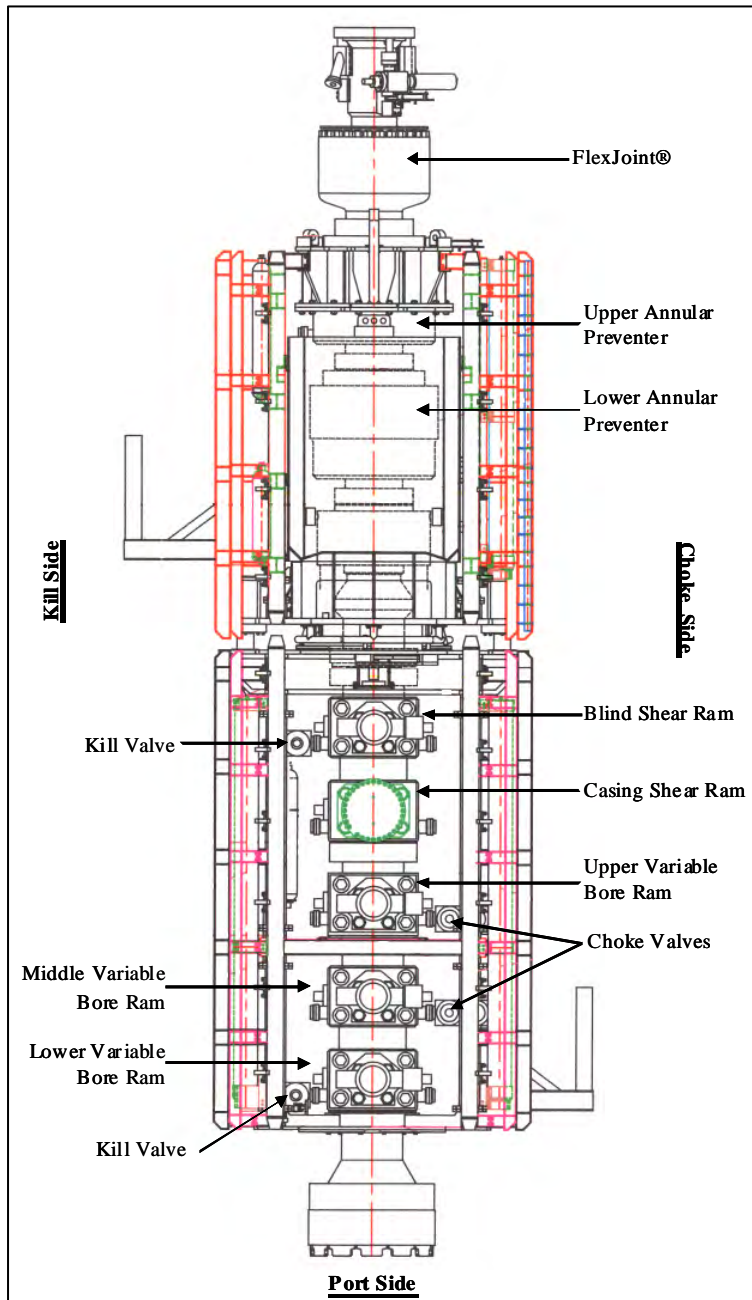

Figure 10 – Schematic of the *Deepwater Horizon* BOP Stack

The table below identifies the installation dates of the following *Deepwater Horizon* stack components:<sup>327</sup>

<sup>327</sup> TRN-USCG\_MMS-00097144.



| <b>Component</b>              | <b>Date Installed</b>      |
|-------------------------------|----------------------------|
| Lower Pipe Ram                | August 2000 <sup>328</sup> |
| Middle Pipe Rams              | August 2000                |
| Upper Pipe Rams               | August 2000                |
| Shearing / Blind Rams         | April 2007                 |
| Casing Shear Rams             | September 2009             |
| Lower Annular                 | Overhauled – October 2007  |
| Upper Annular                 | Overhauled – October 2007  |
| Upper Kill Failsafe Valve     | October 2007               |
| Lower Kill Failsafe Valve     | December 2006              |
| Upper Choke Failsafe Valve    | June 2005                  |
| Lower Choke Failsafe Valve    | January 2006               |
| Bleed Kill Failsafe           | August 2009                |
| Mud Boost Valve               | June 2004                  |
| LMRP Connector                | January 2005               |
| Wellhead Connector<br>Cameron | Overhauled – October 2009  |

Figure 11 – BOP Component Installment Dates

### ***B. Control and Power Systems***

The *Deepwater Horizon* had a multiplex control system that used both subsea and surface equipment to operate the BOP stack. The control system was designed to operate and monitor the closing mechanisms in the BOP stack. The system used both hydraulic and electrical power to control different elements.

The hydraulic power unit located on the *Deepwater Horizon* provided the hydraulic power fluid that could operate the different functions on the BOP stack and the LMRP. Accumulator bottles both on the surface and subsea provided hydraulic power to the system. The hydraulic power unit and the accumulators had sufficient fluid capacities to be able to operate the various BOP stack functions.<sup>329</sup>

<sup>328</sup> As previously noted, this was subsequently converted to a test ram.

<sup>329</sup> CAMCG- 00000236. These volumes were consistent with API specifications.

The microprocessor-based control system on the *Deepwater Horizon* BOP stack received AC power from an uninterruptable power supply unit, which was designed to keep surface and subsea equipment operational under all conditions. All primary functions of the BOP stack were controlled through the multiplex cables, which connected the rig to the BOP stack. As a result, the loss of the multiplex cables would result in loss of power and loss of control of these functions. To ensure operational redundancy and AC power supply, the uninterruptable power supply unit included a battery system able to provide power to the panels, diverter controls, event logger and pods for at least two hours of normal operation.<sup>330</sup>

Cameron offers an option for a rig to have the ability to monitor each pod's battery voltages from any control panel. The *Deepwater Horizon* did not have this additional Cameron technology, which would have enabled the rig crew to monitor battery voltages.

### C. *Emergency Disconnect System*

The emergency disconnect system is a system that can allow the rig to separate from the BOP. This system can be activated from three different locations: (1) the driller's control panel; (2) the bridge; or (3) the subsea engineer control room. The BOP had two emergency disconnect systems sequencing options, referred to as "EDS 1" and "EDS 2." Both emergency disconnect system options were designed to close the BSRs, close the choke and kill valves, and unlatch the LMRP Connector, along with choke and kill connectors. EDS 2, however, would also activate the casing shear ram.<sup>331</sup> The step-by-step sequences for the *Deepwater Horizon's* emergency disconnect system are in Appendix H.

The hydraulic power to perform the emergency disconnect system sequence came primarily from the conduit.<sup>332</sup> Upon activation, however, two functions – the high pressure closing of the BSR and of the casing shear ram – would receive their hydraulic power from the BOP stack mounted accumulators.

---

<sup>330</sup> *Id.*

<sup>331</sup> BP-HZN-MBI00010443.

<sup>332</sup> *Id.* The conduit in turn received its supply from the hydraulic power unit from the surface. This unit had at least two triplex pumps to supply the pressure to the accumulator bank through the conduit.

The multiplex umbilical cables provided the electrical power and communication to the pods. The electrical power originated from power and communication cabinets located on the surface. The cabinet has a dedicated uninterruptable power supply that provided electrical power to subsea systems for a minimum of two hours if main power from the rig was interrupted or removed. There were control panels on the rig that would allow the rig crew to send emergency disconnect commands to the subsea equipment. The commands were transferred to the BOP stack through control pods that were connected to the rig by multiplex umbilical cables.<sup>333</sup>

#### D. *Automatic Mode Function (“Deadman”)*

The automatic mode function (“AMF”) or “deadman” system is designed to close the BSR in the event that the LMRP suffers the loss of electrical power, the loss of fiber-optic communication with the rig, and the loss of hydraulic pressure from the rig. The accumulator bottles located on the lower BOP stack provided the hydraulic power for the AMF.<sup>334</sup> The step-by-step AMF sequence for the *Deepwater Horizon* is in Appendix H.

The AMF relied upon two redundant control pods – a blue pod and a yellow pod. Under normal operations, the pods were powered through AC cables from the surface. In the event of a loss of power from the surface, the power supply for each of the control pods was maintained through batteries located in the subsea electronics module (“SEM”) in the multiplex section of each pod. The pods were located on opposite sides of the LMRP. Each functioned independently and each had its own power supply and batteries. Each pod included solenoid valves, which were devices that opened and closed in response to electrical signals. The solenoids were designed to communicate with the BOP elements and trigger the delivery of 4,000 psi closing pressure to the BSRs through the dedicated accumulator bottles located on the lower BOP stack.

#### E. *Autoshear Function*

The autoshear function is designed to close the BSR in the event of an unplanned disconnect of the LMRP from the lower BOP stack. A poppet valve

---

<sup>333</sup> *Id.*

<sup>334</sup> *Id.* The AMF is usually designed for events such as the riser parting. If the riser parts at the lower flex joint or some other part of the riser system, the AMF sequence is designed to activate to seal the well.

was located between the LMRP and the lower BOP that would fire in the event the LMRP was raised accidentally. This enabled 4,000 psi closing pressure to be applied to the BSR through the dedicated accumulator bottles located on the lower BOP stack. This would seal the wellbore in spite of the loss of conduit supply pressure from the surface.

## *F. Forensic Examination of the BOP*

### *1. Retrieval and Transport of the BOP to Michoud*

After the uncontrolled flow of hydrocarbons from the Macondo well was stopped, a team directed by the Unified Area Command and the JIT worked to retrieve the *Deepwater Horizon* BOP stack from the sea floor, using the Q4000 vessel. The team successfully retrieved the BOP stack on September 4, 2010.

The JIT took a number of steps immediately following the BOP's retrieval designed to preserve the condition of the BOP stack. The goal of these preservation measures was to displace seawater and BOP stack fluids within the BOP control system, the hydraulic operating system, and the stack cavities to minimize corrosion of the BOP stack upon exposure to the atmosphere. To do this, it was necessary to function a number of the BOP stack components; however, three sections of drill pipe were discovered inside the BOP stack. The sections of the drill pipe were removed and preserved for further analysis. The JIT modified the preservation procedures to prevent disturbance of the additional drill pipe found inside the BOP stack, and immediately took steps for wellbore preservation steps in preparation for transport to shore.

After the preservation steps were completed, a barge transferred the BOP stack to the National Aeronautics and Space Administration ("NASA") Michoud Assembly Facility in New Orleans. The Michoud facility is a secure federal site where the examination could be conducted. Site preparation activities included constructing a test pad capable of supporting the approximately 325-ton BOP stack, deployment of environmental containment equipment, and construction of a temporary structure to house the BOP stack.

### *2. Scope of the Forensic Examination*

The JIT retained Det Norske Veritas ("DNV") to prepare a forensic testing plan, to conduct the forensic examination, and prepare a report containing detailed findings based on the forensic examination of the BOP stack. The

objectives of the forensic examination were to determine how the BOP stack performed during the blowout, identify any failures that may have occurred, determine the sequence of events leading to any potential failures of the BOP stack, and evaluate the effects, if any, of a series of modifications to the BOP stack that BP and Transocean officials had implemented before the blowout.

The examination was designed to evaluate: (1) whether leaks on the BOP stack were factors in the BOP stack's performance during the blowout and during the ROV intervention efforts; (2) whether any modifications made to the control logic and stack adversely affected the BOP stack's performance; and (3) whether any other relevant factor, including manufacturing defects, deferral of necessary repairs affecting functionality, and maintenance history affected the BOP's ability to operate as intended.

The forensic examination sought to recreate the pre-blowout conditions of the BOP stack. Two methods were used to achieve this: (1) working backwards from the current condition of the BOP stack through all of the interventions; and (2) comparing the as-received condition of the BOP stack with drawings and records reflecting the state of the BOP stack prior to April 20, 2010.

DNV's investigative process was an iterative process that integrated the BOP stack function testing, the collection of evidence, preservation of evidence (especially the drill pipe contained in the wellbores of the BOP and LMRP), examination of materials, damage assessment and video and photo documentation.

### 3. *The Forensic Examination Technical Working Group*

During intervention operations, the companies familiar with the *Deepwater Horizon* BOP stack identified many modifications made to the stack since its original delivery by Cameron. As a result, technical consultation with Transocean and Cameron was critical for both the effectiveness of examination and for the safety of the examiners. Recognizing this, a technical working group ("TWG") was established to provide DNV with technical support and expertise as DNV conducted its forensic examination. The TWG included one expert and one alternative each from Cameron, Transocean and BP; an expert working for the United States Department of Justice; two experts representing the plaintiffs in

the multi-district litigation; and an expert nominated by the Chemical Safety Board.<sup>335</sup>

The members of the TWG provided DNV with input and suggestions for testing protocols and other technical support. DNV held daily morning meetings with the TWG to discuss each day's planned forensic testing activities. Through participation in morning meetings and observation of DNV's work, TWG members were able to monitor all day-to-day forensic testing activities.

### *G. Examination Methods Used by DNV*

#### *1. Forensic Testing Plan*

At the request of the JIT, DNV developed and submitted for JIT approval a forensic testing plan. The plan included forensic testing procedures for the BOP stack and its components in accordance with established and accepted protocols, methods, and techniques.<sup>336</sup> DNV's forensic testing plan was also submitted to the TWG and the parties in interest ("PIIs") for review and comment. Where appropriate, DNV revised its test plans to address comments received. The JIT approved DNV's revised forensic testing plan on October 27, 2010.<sup>337</sup>

#### *2. BOP Stack Testing*

After the BOP stack arrived at the Michoud testing site, DNV visually inspected the stack and recorded all visible numbers including serial numbers. DNV examined internal components using a camera and video borescope. DNV then completed the following tasks: (1) determination of the final position of the annular preventers and rams; (2) examination of the condition of the BOP and the LMRP; (3) removal of the drill pipe from the BOP and the LMRP; (4) removal

---

<sup>335</sup> The U.S. Chemical Safety Board ("CSB") is an independent federal agency charged with investigating industrial chemical accidents.

<sup>336</sup> The protocols included professional video recording of the entire examination and complete photographic documentation.

<sup>337</sup> The protocols in DNV's forensic testing plan were not meant to be a step-by-step set of procedures. As with many forensic examinations, the test plan provided a roadmap for meeting the objectives, but needed to be adapted as the testing progressed. DNV submitted additional protocols that were outside of the scope outlined in the original testing plan to TWG for review and comment and to the JIT for approval.

of the ram blocks; and (5) function testing of critical functions and circuits that were involved in the attempts to control the well during the first two days following the blowout.<sup>338</sup>

### 3. *Materials Evaluation and Damage Assessment*

Another critical part of DNV's forensic work was materials evaluation and damage assessment. Materials evaluation included: (1) cleaning and examining the BOP rams; (2) cleaning and examining drill pipe segments removed from the BOP stack and the riser; (3) cleaning and examining components extracted during the removal of the rams; and (4) collecting and cleaning all solid objects found within the different ram cavities.

DNV assessed the damage to the BOP stack in three different ways: (1) visual inspection and photo documentation; (2) dimensional measurements; and (3) three-dimensional laser scanning. In addition, DNV used structural analysis and modeling to simulate drill pipe behavior in the wellbore.<sup>339</sup>

### 4. *ROV Intervention Operations Review*

DNV reviewed video footage and still photographs taken from a number of different ROVs that were used during attempts to stop the well flow. This review allowed DNV to assess the condition of the BOP stack when it was still submerged and to try to determine the origin of leaks in the BOP's hydraulic circuitry. This review also allowed DNV to assess the impact of various ROV interventions on the condition of the BOP stack.<sup>340</sup>

## H. *DNV's Forensic Examination Findings*

DNV's forensic examination found that, as the BSR was closed, the drill pipe was positioned such that the outside corner of the upper BSR blade contacted the drill pipe slightly off center of the drill pipe cross section. A portion of the pipe cross section was outside of the intended BSR shearing surfaces and would not have sheared as intended. As the BSR closed, a portion of the drill pipe cross section became trapped between the ram block faces, preventing the blocks from fully closing and sealing.

---

<sup>338</sup> DNV Report, Vol. 1, at 23-24.

<sup>339</sup> *Id.* at 23.

<sup>340</sup> *Id.* at 24.

DNV's forensic examination found that the main failure of the *Deepwater Horizon* BOP stack was caused by a portion of the drill pipe being trapped outside of the blind shear ram cutting surfaces, which prevented the blind shear rams from fully closing and sealing. DNV was able to reconstruct the segments of recovered pipe through analysis of the segments of pipe and tool joints that were located throughout the BOP and riser, including analysis of wear patterns, drill pipe dimensions, damage and deformation markings, sheared ends of recovered drill pipe, and physical differences between the two recovered joints of drill pipe. DNV also determined that a tool joint had been located in the upper annular while flow was present. DNV also noted the as-received condition of many BOP stack components, i.e., blue and yellow pod battery voltages and various ram positions. DNV's report is included at Appendix D.

#### 1. *Sequence of Events Related to the Blind Shear Rams*

There are two possible scenarios for how the blind shear rams were activated and closed: (1) the autoshear circuit was activated on April 22, by cutting the poppet valve between the LMRP and lower BOP stack; or (2) the automatic mode function had been activated by loss of the multiplex and hydraulic lines on April 20. In its reports prepared for BOEMRE, DNV presented findings with respect to both of these scenarios. However, DNV concluded that the most likely scenario for the activation of the blind shear ram was from the autoshear circuit.<sup>341</sup>

By the time the BSR was activated and closed, the drill pipe was positioned outside of the BSR blade surfaces. As the BSR closed, this portion of the drill pipe became trapped between the ram block faces and prevented them from fully closing and sealing. This resulted in a 2.8 inch gap between the blocks, as estimated by a DNV model.

DNV concluded that, at the time of the blowout, there was a drill pipe tool joint located between the closed upper annular and the closed upper VBR, which the Panel concluded were properly spaced out. The Panel believes that the rig crew manually closed the upper VBR because the upper VBR cannot be remotely activated from the hot stab panel. During the post-blowout well intervention

---

<sup>341</sup> In its report, DNV stated that it could not rule out the possibility that the BSRs were closed through activation of the AMF circuits.



operation, once the pods had been pulled and rerun, only 2.3 gallons of hydraulic fluid were pumped to close the upper VBR. This would have been an insufficient amount of fluid to close the VBR had it been in an open state. Furthermore, DNV found no cut upper VBR hydraulic hoses during intervention. The VBR was also found to be in the closed position at Michoud.

DNV found that multiple forces acted upon the drill pipe during the blowout, resulting in the “elastic buckling” of the drill pipe. Elastic buckling can occur when a structural element loses stability when force is applied. Once the force causing the buckling is removed, the object reverts to its original form.

The Panel determined that either of the following scenarios, or some combination of them, led to the elastic buckling of the drill pipe at the time the blind shear ram activated, which contributed to the failure of the blind shear ram to cut the drill pipe and seal the well:

- The forces from the blowout acting on the drill pipe pushed the tool joint into (or further into) the upper annular element. The drill pipe was then unable to move upward at the upper annular but was able to move upward at the upper VBR; and/or
- The draw works (the equipment on the rig that supports the drill pipe that is lowered into the riser) collapsed shortly after the explosions, thus allowing approximately 150,000 lbs of unsupported drill pipe to act as a downward force against the upper VBR.<sup>342</sup>

Regardless of the conditions that led to the elastic buckling, DNV concluded that, based upon the physical evidence of the drill pipe, wellbore, and the BSR blocks, the drill pipe became trapped between the BSR faces, which prevented the BSR from fully closing.<sup>343</sup> See Figure 12 below. DNV found that these conditions likely occurred “from the moment the well began flowing and would have remained until either the end conditions changed (change in Upper Annular or Upper VBR state) or the deflected drill pipe was physically altered (sheared).”<sup>344</sup>

---

<sup>342</sup> Testimony of Daun Winslow, Joint Investigation Hearing, August 23, 2010, at 452.

<sup>343</sup> Addendum to Final Report for United States Department of the Interior – Bureau of Ocean Energy Management, Regulation and Enforcement – Forensic Examination of the Deepwater Horizon Blowout Preventer (April 30, 2011) (“Addendum to DNV Report”) at 11.

<sup>344</sup> DNV Report, Vol. 1 at 4.

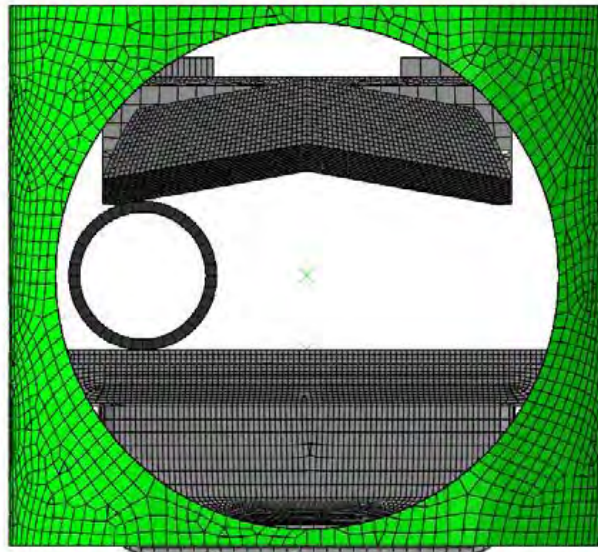

Figure 12 – Off-center drill pipe (Source: DNV)

## 2. *Activation of the Casing Shear Rams*

During intervention efforts, on April 29, the drill pipe was sheared using the casing shear ram (“CSR”).<sup>345</sup> DNV found that the shearing of the drill pipe changed the flow pattern within the wellbore. At the BSR, the flow had been through the partially sheared drill pipe; the new path allowed flow up the entire wellbore, starting at the CSR through the 2.8 inch gap along the entire length of the block faces.

## 3. *Automatic Mode Function*

DNV concluded that it could not rule out the possibility that the BSR was closed through activation of the automatic mode function circuits.<sup>346</sup> DNV found that there was evidence that “conditions necessary for AMF/Deadman (loss of power, communication and hydraulic pressure) existed immediately following the explosion/loss of rig power and prior to ROV intervention.”<sup>347</sup> DNV stated that its function testing demonstrated that the AMF circuits within both pods activated when the loss conditions were simulated. Function testing on the blue

---

<sup>345</sup> DNV Report, Vol. 1 at 5.

<sup>346</sup> *Id.*

<sup>347</sup> *Id.* at 169. Modifications to the BOP stack are included in a timeline at Appendix F of the DNV Report, Vol. 2 (Appendix D of this Report).

pod showed that, in its as-received condition, the 27-volt batteries on the blue pod did not have enough power to complete the AMF sequence.<sup>348</sup>

Function testing of the yellow pod yielded inconsistent results due to one of the solenoids (solenoid 103Y).<sup>349</sup> A solenoid valve, in response to an electrical signal, opens or closes a hydraulic circuit to function BOP stack components. This functioning allows hydraulic fluid to close the BSR.

### *I. Evaluation of Other Possible Failures*

During the ROV interventions, there were reports of leaks in various hydraulic circuits. DNV found that “the evidence indicates the reported leaks in the hydraulic circuits were not a contributor to the Blind Shear Rams being unable to close completely and seal the well.”<sup>350</sup>

DNV reviewed various modifications made to the control logic or to the BOP stack prior to the blowout. DNV found that “there is no evidence these modifications were a factor in the ability of the Blind Shear Rams being able to close fully and seal the well.”<sup>351</sup>

DNV tested the performance of solenoid 103Y that was removed from the yellow pod and obtained inconsistent results. DNV observed that, when both coils within the solenoid were activated (which is what should happen if the solenoid was activated by the AMF circuits), the solenoid functioned properly. But when only one of the coils was activated, the solenoid failed to function properly. DNV posited two theories for why this occurred. First, the solenoid was removed in May 2010 but was not tested until March 2011. DNV found that it was possible that seawater deposits or hydraulic fluid build-up was the cause of the inconsistent results. Second, it was possible that the solenoid had a manufacturing defect. DNV stated that it “did not identify any other issues or evidence that manufacturing defects of one form or another contributed to the Blind Shear Rams not closing completely and sealing the well.”<sup>352</sup>

---

<sup>348</sup> However, the Panel found that this was not conclusive because the blue pod may have performed the AMF sequence some time after the loss of well control, which may have caused its as-received condition.

<sup>349</sup> DNV Report, Vol. 1, at 171-72.

<sup>350</sup> *Id.* at 171.

<sup>351</sup> *Id.* at 172

<sup>352</sup> *Id.*

DNV stated that its tests of the blue pod in its as-received condition demonstrated that “the 27 Volt battery in the Blue Pod had insufficient charge to activate the solenoid 103B.” DNV noted that there were no records showing that the batteries in the AMF system were tested during a factory acceptance test in June 2009.<sup>353</sup> DNV further noted that tests for the 27-volt battery conducted in July 2010 (when the BOP was retrieved) “reported the battery level to be out of specification.”<sup>354</sup>

The *Deepwater Horizon* crew did not have the ability to monitor the subsea electronic module (“SEM”) battery power supply, although the Panel is aware of technology that exists that would allow Transocean to perform this monitoring. If the crew had been able to monitor the SEM power supply, they could have known the real time condition of the AMF batteries.

Two other theories regarding the failure of the BOP stack were advanced during JIT hearings. The first is that the hydraulic systems that powered the BSR did not have enough power to cause the blind shear rams to fully close and seal. A Cameron representative stated:

There is a possibility that the shear ram could have been functioned not through the high pressure circuit but through the manifold pressure, which would be 1,500 PSI, and it's possible that if that happened, we wouldn't have near enough hydraulic force pressure - you could not generate enough force with that pressure to cut the pipe. In fact, it's very likely that the pipe would only be dented and not shear all the way through, exposing the ram to the flows that we all have heard about. It's also possible that for whatever reason the hydraulic system wasn't up to the game that day and didn't have sufficient pressure to close it. It is possible that the solenoid valve, which when tested by DNV in Michoud, operated intermittently, sometimes it wouldn't operate at all and other times it would operate for a handful of seconds. And it is possible that if the deadman fired and the solenoid valve did exactly what it did at Michoud, that the ram could have partially deployed and not gone all the way across.<sup>355</sup>

---

<sup>353</sup> *Id.*

<sup>354</sup> *Id.* at 170.

<sup>355</sup> McWhorter testimony at 144-45.

DNV discounted this theory for a number of reasons. First, under this theory, someone on the bridge would have had to activate the BSR normal close function from the toolpusher's control panel or the driller's control panel. DNV concluded that no witness testimony supported this. Second, DNV pointed to the testimony of Chris Pleasant, the Transocean subsea engineer, who testified that the BSR was in an "open" state when he arrived at the bridge at approximately 9:56 p.m. This was further evidence that no one had activated the "close" function.

The second theory advanced was referred to as the "double clutch" theory, which posited that the solenoid of the ROV supplied just enough pressure to the hydraulic port on the BOP to cause the BSR to go only partially into the wellbore.<sup>356</sup> The Cameron representative described this as follows:

Also, there were at least a handful of cases during the course of the intervention in which the shear rams were double clutched. In other words, pressure was applied to the BOP and then it was relieved. It was applied and relieved. There were at least a handful of times in which that happened. . . <sup>357</sup>

DNV concluded that "[t]he overall contribution of this 'double clutching' phenomenon cannot in DNV's opinion be of significance compared to the contribution of the trapped pipe between the ram blocks."<sup>358</sup>

#### *J. Studies Evaluating the Reliability of BOPs*

Within the last decade, MMS, through its Technology Assessment and Research Program ("TA&R"), funded or co-funded various studies regarding the reliability of BOP systems in deepwater applications, shear ram capabilities, and the evaluation of secondary intervention methods in well control.<sup>359</sup> Some of these studies pointed out deficiencies in BOP systems and made suggestions to change MMS regulations and/or industry standards.

---

<sup>356</sup> The ROV has a robotic arm that fits into a hydraulic port on the BOP stack to pump hydraulic fluid into the BOP to close the ram blocks.

<sup>357</sup> McWhorter testimony at 145.

<sup>358</sup> Addendum to the DNV Report, at 10.

<sup>359</sup> The TA&R Program supports research associated with operational safety, pollution prevention and oil spill response and clean up activities.

Of particular note were the 2004 West Engineering Services studies *Review of Shear Ram Capabilities* and *Evaluation of Shear Ram Capabilities* (TAR studies 455 and 463).<sup>360</sup> The main goal of these studies was to answer the following question: can a rig's BOP equipment shear the pipe to be used in a given drilling program, at the most demanding condition to be expected, and, if so, at what pressure? Before answering this question, one of the studies noted that "[s]hear rams may be a drilling operation's last line of defense for safety and environmental protection." In arriving at several conclusions and recommendations, the report described a failure rate of 7.5% where the rams tested failed to shear pipe while working in a maximum closing force pressure of 3,000 pounds per square inch.

In a 2003 West Engineering Services study funded by MMS, the study acknowledged that shear ram blocks were not designed to close and seal under high rate conditions if closure rates were slow. The study also noted that API Specification 16A did not require testing for rams under dynamic flowing conditions. The MMS regulatory response was to require operators to submit documentation showing that the shear rams that they used in their BOP were capable of shearing pipe in the hole under maximum anticipated surface pressures.

---

<sup>360</sup> This study followed an MMS-funded research project in 2003 (TAR study number 431) that evaluated secondary intervention methods in well control. The goal of the research was to evaluate the capabilities of the secondary BOP intervention systems in place at the time of study, and identify the best practices in use and not yet in use. The objectives of the study were to compare and contrast the capabilities of available secondary intervention technologies; review and contrast existing secondary intervention systems in place on deepwater drilling rigs; discuss possible enhancements to existing systems, their benefits, and their costs; and recommend the best practices for operations in less than and greater than 3,500' water depth. For a rig in the dynamically positioned (DP) mode operation with a multiplex BOP control system, like the *Deepwater Horizon*, the study recommended the following secondary systems: an emergency disconnect system, a "deadman" system to supplement the EDS system, the addition of an autoshear circuit to a rig that had an AMF system, and an ROV. The *Deepwater Horizon* was equipped with an emergency disconnect system, a "deadman" system, an "autoshear" system, and ROV intervention capabilities.

## ***K. Maintenance of the Deepwater Horizon BOP***

The following sections provide details about Transocean's maintenance of the *Deepwater Horizon* BOP stack and the BOP stack's condition at the time of the blowout.

### *1. Transocean Maintenance Plans*

Transocean began to use a maintenance tracking system called RMS II shortly after its merger with Global Santa Fe in 2007. The RMS II system is designed to automatically flag components in need of scheduled maintenance, to order parts, and to create work orders.

Transocean senior subsea engineer Mark Hay described the RMS II system as a "preventative maintenance system" used to tell the rig personnel which pieces of equipment were due for maintenance. Transocean used this maintenance tracking system to determine the different types of work that needed to be done on the *Deepwater Horizon* BOP stack.<sup>361</sup> Transocean had procedures to track maintenance on BOP components within their RMS II system; however, the Company did not effectively track maintenance work on each specific component.

The preventative maintenance orders generated from within the RMS II system are developed using items such as original equipment manufacturer ("OEM") recommendations for replacing equipment based on lifetime service hours, loads and pressures, routine rig move maintenance work-lists, the 365/1095/1825-day preventative maintenance work-lists, as well as the subsea maintenance philosophy.

### *2. Transocean Subsea Maintenance Philosophy*

Transocean relied on a document entitled "Transocean Recommended Practices, Subsea Maintenance Philosophy" that contained the company's maintenance "philosophy" for subsea equipment.<sup>362</sup> In the document, Transocean provided guidance for subsea planned maintenance tasks and for planning for maintenance to be completed while the BOP stack was being moved

---

<sup>361</sup> Testimony of Mark Hay, Joint Investigation Hearing, August 25, 2010, at 237.

<sup>362</sup> Transocean Recommended Practices, Subsea Maintenance Philosophy, May 2007, HQS-OPS-RP-400-001.

from one well to another. The document also sets forth required documentation including maintenance records, pre/post deployment sign off, and component condition evaluation. The document also covered the actual maintenance, overhaul and testing of the subsea equipment. Section 8 of the document required full function testing of the equipment prior to deployment.

Transocean required two forms to be completed and stored electronically: a pre-deployment sign-off sheet and a component condition evaluation form. Transocean provided the Panel with three pre-deployment sign off sheets. However, Transocean was unable to produce copies of the component condition evaluation forms or similar documents.<sup>363</sup> Michael Fry, a Transocean equipment manager, testified about why the component condition evaluation form was not utilized:

When the subsea maintenance philosophy was originally created, the thought process behind this form was to establish mean time between failures and documenting problems that we were having with equipment that we had failures with. This document wasn't really utilized, because what we ended up doing was the major [original equipment manufacturers] have forms, like discrepancy forms, that when you send in a piece of equipment -- Cameron, for example, uses what's called an FPR form, I believe it's field performance report, ...

We felt later on it was best to just have the equipment sent back to the OEM and let them do a formal investigation of any failures and to have them submit the inspection reports back to us.<sup>364</sup>

Although Fry testified that Transocean relies upon these reports to make changes to their maintenance and should have ready access to them, the Panel found that the component condition documentation for the *Deepwater Horizon* was kept on the rig, and Transocean did not appear to electronically store the reports elsewhere.<sup>365</sup>

Section 10 of the maintenance philosophy document further explained that all subsea equipment was subject to an approved 1,825-day test and inspection/survey and, for the Gulf of Mexico, the 1,825-day overhaul was

---

<sup>363</sup> TRN-USCG\_MMS-00097219.

<sup>364</sup> Testimony of Michael Fry, Joint Investigation Hearing, April 6, 2011, at 49-50

<sup>365</sup> *Id.* at 50.



dependent on the findings of the major survey. During JIT hearings, Fry was asked about the confusion surrounding the verification of the 1,825-day major overhaul start date and how the Panel could determine when the *Deepwater Horizon's* BOP stack components were installed. Fry responded:

Ram blocks, recertification of ram blocks - I mean, a ram block that gets inspected gets inspected for damage. It gets a hardness check. It gets a non-destructive testing inspection done on it. If there's no damage to it, again, there's no requirement for a mandatory recertification of it. Normally, to kind of expand on your question, the start date is from the date of the COC.<sup>366</sup>

A certificate of conformity or certificate of compliance ("COC") was issued by the OEM. The Panel could not locate any Cameron COC for the VBR bonnets since the installation date in 2000. Transocean also submitted documentation stating the VBR ram blocks had not been completely overhauled since installation in 2000.<sup>367</sup>

The Panel also never received documentation on the required 1,825-day inspection, which should have been done in 2005 for the VBR bonnets. According to Transocean's subsea items scheduled to be worked on during the 2011 shipyard visit, they were scheduled to "replace or rebuild all 6 bonnets on pipe rams."<sup>368</sup>

### 3. *"Condition Based" Monitoring and Maintenance*

In testimony, Transocean personnel articulated an approach to BOP stack maintenance that they referred to as "condition based monitoring" or "condition based maintenance." Transocean subsea superintendent, William Stringfellow, described this approach as follows:

Again, we use condition-based monitoring, and we look at [API] RP 53 as a recommended practice. Using our condition-based monitoring and testing of our systems, we can determine what kind of condition those BOPs are actually in. And we have history to back this up through – we've actually pulled BOPs down within this time frame and there not be

---

<sup>366</sup> Fry testimony at 46.

<sup>367</sup> TRN-USCG\_MMS-00097144.

<sup>368</sup> TRN-USCG\_MMS-00096390.

anything wrong with them. You put new seals in them, you put them back together, and they're good to go.

And we determined that by performing condition-based monitoring, and in seeing any changes, whether it be through reaction times or pressure, that we can determine whether this is worthy for work or whether we need to be looking at replacing this piece of equipment.<sup>369</sup>

Stringfellow further explained:

To take some of this equipment and disassemble it and inspect it and then put it back into service - you have to look at maintenance history, and that's something that I think that, you know, that you're not aware of, of the things that we've seen in the past to build this condition-based monitoring, which we put a lot of time and effort into for this equipment.

By doing this, we feel that we cut risk of taking – we've had brand-new pieces of equipment go into service and fail. It's called infant mortality.<sup>370</sup> And – and – and we can get off into this and into much deeper talk – you know, discussions. But, again, what we see right here in the way that we're doing this, we feel that we have a piece of equipment down there that will do what it's designed to do.<sup>371</sup>

Most of the maintenance done by Transocean as a result of condition-based monitoring occurs when a drilling rig moves from one location to another.<sup>372</sup> This minimizes rig downtime and the costs associated with performing the maintenance. Stringfellow testified:

Taking BOP bodies completely apart, and say, checking the sealing areas of ring gaskets. We found that by disassembling these areas, to do an inspection on them and then put them back together, we have more issues with them than after we disassemble them than we do before. I mean, we never had a problem.

---

<sup>369</sup> Testimony of William Stringfellow, Joint Investigation Hearing, August 25, 2010 at 358-59.

<sup>370</sup> One witness described the "infant mortality" concept that equipment can fail sooner from performing too much maintenance, disassembly, and overhaul of equipment. Fry Testimony at 69.

<sup>371</sup> Stringfellow testimony at 375-76.

<sup>372</sup> Hay testimony at 255.

\* \* \*

So, I mean, you're talking about pulling the rig out of service and – and, there again, the practicality of doing this and what you gain by doing this is weighed out.<sup>373</sup>

Mark Hay, Transocean subsea superintendent, testified that it was well-known among the “top-line supervisors” on the *Deepwater Horizon* that the BOP stack was outside of its three to five year major inspection requirement, and instead Transocean was relying upon its condition-based maintenance.<sup>374</sup>

#### 4. *Planned 2011 Shipyard Maintenance*

Transocean planned to bring the *Deepwater Horizon* in for maintenance at a shipyard in early 2011. The planned maintenance included: (1) replace or rebuild all 6 bonnets on pipe rams; (2) replace both 28 inch super shear ram bonnets; (3) replace Cameron high capacity riser connector; (4) completely replace lower annular with rebuilt annular; (5) replace all control hoses on BOP; (6) replace diverter; (7) replace diverter flex joint; (8) blast and paint both stack and LMRP frames; (9) change out all anodes; (10) rebuild all shuttle valves; and (11) replace or rebuild riser spider and gamble.<sup>375</sup>

#### 5. *Deferring Maintenance on the BOP Stack*

The Panel found that, less than a week before the blowout, BP informed Transocean that it wanted to defer maintenance to the upper and lower annulars (parts of the BOP stack) and agreed to accept liability if the lower annular failed prior to the performance of maintenance work.

Brett Cocales emailed John Guide on April 15 to discuss “Stuff for Paul [Johnson, rig manager].” Cocales informed Guide that “Paul [Johnson] needed a couple of things from us for the upcoming end of well work list.” The first item

---

<sup>373</sup> Stringfellow testimony at 379.

<sup>374</sup> Hay testimony at 205-06. Transocean was using conditioned based maintenance approach notwithstanding the fact that, in 2006, MMS cited its “extended use of the BOP without inspection/maintenance” as a contributing cause of a 2006 pollution event. MMS recommended that “Annular BOP maintenance should be conducted per Transocean Schedule and criteria to reduce wellbore seal, wear, and damage.” MMS found that Transocean had recommended a maintenance schedule, but the crew had failed to follow it. See [http://www.goboemre.gov/homepg/offshore/safety/acc\\_repo/2006/060212.pdf](http://www.goboemre.gov/homepg/offshore/safety/acc_repo/2006/060212.pdf).

<sup>375</sup> TRN-USCG\_MMS-00096390.

stated, "He needs an email from you that states we don't want to change the annulars before the Nile and will accept that liability if both fail during Nile and we have to pull the BOP. We all agree this is a low risk of having 2 failures. This is coming from his upper management that they just wanted our confirmation with an email."<sup>376</sup>

On the same evening, just minutes after receiving the email from Cocalles, Guide sent Paul Johnson an email saying he concurred with not changing the annular elements prior to starting the Nile well. The email stated, "B[P] accepts responsibility if both annulars were to fail and the stack had to be pulled to repair them."<sup>377</sup> While the Panel did not find that a failure of the annulars contributed to the failure of the BOP stack to seal the well, it did find that Guide decided to accept liability on behalf of BP for any annular failures with apparently little or no analysis of the conditions of the equipment.

#### 6. *Effects of the BOP Maintenance Record on Performance*

The Panel found that the Transocean's subsea maintenance plans were generally in accordance with Cameron's maintenance requirements.<sup>378</sup> As noted previously in this Report, the Panel found no evidence that Transocean had submitted the variable bore rams to a major inspection (as defined in API RP 53) any time since installation in 2000.

The Panel did not find any evidence of an actual deficiency in Transocean's maintenance of the BOP stack that played a role in the failure of the BSR to shear the drill pipe and seal the well.

#### L. *BOP System Leaks*

BOP systems may develop hydraulic fluid leaks in their various components. Part of regular BOP stack maintenance is to identify and assess the seriousness of leaks to hoses and valves. While Transocean asserts that there were no leaks on the *Deepwater Horizon* BOP stack when it was deployed at the

---

<sup>376</sup> BP-HZN-MBI00254566.

<sup>377</sup> BP-HZN-MBI00254591.

<sup>378</sup> Cameron Special Procedures identified in EB 902 D, CAMCG 00003345.

Macondo well, rig personnel identified three leaks on the stack prior to the blowout.<sup>379</sup>

The first leak was a “very small” leak on the control hose for the upper annular surge bottle that resulted from a loose fitting.<sup>380</sup> The leak was discovered about two weeks after the *Deepwater Horizon’s* BOP stack was positioned on the Macondo well.<sup>381</sup> The second leak was in the lower annular; the crew never determined where fluid was coming from but through testing ruled out a number of components related to the annular.<sup>382</sup> The third leak was in the lower test ram arising from the one of the solenoids on the yellow pod.<sup>383</sup> The crew function and pressure tested the BOP stack after these leaks were discovered and those tests were successful.<sup>384</sup>

Mark Hay explained Transocean’s process for assessing leaks. When a leak is discovered, he said that “you would talk to the maintenance supervisor and OIM and then you would do a risk assessment on the rig, and then the rig team would make a decision, and you would give field support a call with your findings, your leak rates and all that, and they would determine if it is deemed necessary to pull and make repairs.”<sup>385</sup>

BP noted the leak on the lower test ram in its internal daily operations report from February 23 until March 13.<sup>386</sup> Despite identifying this leak, BP did not take steps to ensure that Transocean reported that leak in the IADC drilling report.<sup>387</sup> Transocean did not record the leak on the upper annular control hose on the IADC drilling report.<sup>388</sup> BP’s John Guide did not believe the leak on the

---

<sup>379</sup> Hay testimony at 242; Pleasant testimony at 113. In addition, response personnel identified BOP system leaks during efforts to shut the well in. It is not known whether those leaks developed post-blowout or existed before the blowout and were not identified by the crew.

<sup>380</sup> Hay testimony at 193-194.

<sup>381</sup> *Id.* at 244.

<sup>382</sup> *Id.* at 193, 195.

<sup>383</sup> *Id.* at 193-194, 196.

<sup>384</sup> *Id.* at 249.

<sup>385</sup> *Id.* at 243.

<sup>386</sup> BP’s Daily Operations Reports, 02/23/10 – 03/13/2010.

<sup>387</sup> *Id.*

<sup>388</sup> *Id.*

lower test ram needed to be reported to MMS because the leak “did not affect the function of the stack.”<sup>389</sup>

The leaks identified did not impede the closing ability of the annular or ram preventers. These leaks did require the placement of the BOP controls into the “block/neutral/vent” position in order to stop or slow the hydraulic leak. The Panel concluded that these leaks did not impede the functionality of the BOP stack.

#### *M. ROV Interventions*

Numerous attempts were made to shut in the well using ROVs after the rig was evacuated. On April 21, BP initially attempted to activate the middle pipe ram; however, personnel experienced problems with insufficient ROV pump volumes and hot stab tools.

On April 22, BP used an ROV to try to activate the autoshear function, which would have closed the BSR. The ROV was unable to sufficiently cut the poppet valve to activate the autoshear.<sup>390</sup> The next ROV attempt, on April 22, to close the BSR by “hot stabbing” was not successful either.<sup>391</sup> This attempt was hampered by the fact that the BOP stack had been modified to convert a variable bore ram into a test ram at BP’s request.<sup>392</sup> The response team was not aware of this until early May and thus made multiple efforts to hot stab the test ram under the belief that they were hot stabbing a pipe ram.<sup>393</sup>

Again on April 22, BP successfully cut the poppet valve for the autoshear. This is the scenario that the Panel and DNV Report conclude likely closed the BSR, but failed to seal the well. From April 25 through May 5, BP tried 17 additional ROV interventions to close various BOP rams and annular preventers. Even though BP was able to operate many of the BOP components, none of the attempts was successful in shutting in the well.

---

<sup>389</sup> Guide testimony, July 22, 2010 at 229. However, one of the BP well site leaders on the rig, Ronald Sepulvado, testified that he believed the leak should have been recorded in the IADC Report. Sepulvado testimony at 26-27.

<sup>390</sup> DNV Report, Volume 1 at 135.

<sup>391</sup> *Id.* To “hot stab” is to insert a hydraulic pump, by means of an ROV’s robotic arm, into a hydraulic port on the BOP stack to pump hydraulic fluid into the BOP ram closing system.

<sup>392</sup> BP-HZN-MBI-00136647; BP, *Deepwater Horizon* Accident Investigation Report at 172.

<sup>393</sup> Testimony of Harry Thierens, Joint Investigation Hearing, August 25, 2010 at 103-105.

From the outset of ROV interventions, Transocean could not produce the redline (as built) drawings to know how the BOP components worked and were configured. Throughout the intervention, drawings had to be updated in accordance with what was observed from ROV footage. According to Transocean, they kept the redline drawings on the *Deepwater Horizon* and the documents went down with the rig.

### **XIII. BOP Stack Conclusions**

The Panel concluded that on April 20, 2010, the *Deepwater Horizon* crew closed the upper annular on the BOP stack at 9:43 p.m. as part of its initial efforts to control the well. At 9:47 p.m., the crew closed the upper variable bore rams as part of their continuing efforts to control the well. When the well blew out, there was a drill pipe tool joint located between the closed upper annular and the closed upper variable bore rams.

#### **A. Cause of the BOP Stack Failure**

The Panel concluded that there are two possible scenarios for when the BSR was activated. First, the BSR could have been activated by the AMF while the pipe was placed in compression by the upper annular preventer immediately following loss of communication with the rig. Second, the BSR could have been activated by the autoshear on April 22, while the pipe was placed in compression by the weight of the drill pipe and upward forces of the well. Under either scenario, the BSR failed to shear the drill pipe and seal the wellbore because the pipe was placed in compression outside of the cutting surface of the BSR blades. **The Panel concluded that failure of the BOP to shear the drill pipe and seal the wellbore was caused by the physical location of the drill pipe near the inside wall of the wellbore, which was outside the BSR cutting surface during activation on April 20 or April 22.**

#### **B. BOP Stack Failure Contributing Causes**

The BSR could not fully close and seal because a portion of the drill pipe became trapped between the BSR block faces. **The elastic buckling of the drill pipe forced the drill pipe to the side of the wellbore and outside of the BSR cutting surface, and was a contributing cause of the BOP failure.**

#### **C. BOP Stack Failure Possible Contributing Causes**

Approximately 28 feet of drill pipe between the upper annular and the upper variable bore ram elastically buckled within the wellbore, causing that portion of the drill pipe to be off-center. Either of the following scenarios or some combination thereof, led to elastic buckling of this pipe in this location:



- Scenario 1: Flow from the well forced the section of drill pipe located between the closed VBR and the closed upper annular up into the closed upper annular to a point where a tool joint stopped against the closed upper annular. Wellbore conditions produced enough force to cause the pipe to elastically buckle in this area.
- Scenario 2: Flow from the well and weight of the unsupported 5,000 feet of 6 5/8 inch diameter drill pipe above the closed VBR forced the section of drill pipe located between the upper VBR and the upper annular into an elastically buckled state.

**The forces described above, which led to the elastic buckling of the drill pipe, constituted a possible contributing cause of the BOP failure.**

## XIV. Regulatory Findings

This section addresses regulatory requirements that were in effect on April 20, 2010.<sup>394</sup>

Under the Outer Continental Shelf Lands Act (“OCSLA”), the Secretary of the Interior is authorized to manage and regulate the leasing, exploration, development, and production of resources on the Outer Continental Shelf (“OCS”). The Secretary has delegated this authority to BOEMRE (MMS at the time of the Macondo blowout).<sup>395</sup>

OCSLA provides that lease or permit holders have an affirmative duty to:

- (1) maintain all places of employment within the lease area or within the area covered by such permit in compliance with occupational safety and health standards and, in addition, free from recognized hazards to employees of the lease holder or permit holder or of any contractor or subcontractor operating within such lease area or within the area covered by such permit on the OCS;
- (2) maintain all operations within such lease area or within the area covered by such permit in compliance with regulations intended to protect persons, property and the environment on the OCS; and
- (3) allow prompt access, at the site of any operation subject to safety regulations, to any inspector, and to provide such documents and records

---

<sup>394</sup> Since April 20, 2010, BOEMRE has implemented a number of regulatory reforms aimed at improving drilling and workplace safety. On September 30, 2010, BOEMRE implemented the Interim Final Rule (sometimes referred to as the “Drilling Safety Rule”) and the Workplace Safety Rule (sometimes referred to as the “SEMS Rule” for Safety and Environmental Management Systems). The Interim Final Rule created new standards for well design; casing and cementing; and well control procedures and equipment, including blowout preventers. The Workplace Safety Rule required operators to systematically identify and address risks in order to reduce the human and organizational errors that lie at the heart of many accidents and oil spills. Effective November 11, 2011, operators in the U.S. will be required to have a comprehensive SEMS program that identifies the potential hazards and risk-reduction strategies for all phases of activity, from well design and construction, to operation and maintenance, and finally to the decommissioning of platforms.

<sup>395</sup> Effective October 1, 2011, BOEMRE will be reorganized into two bureaus – the Bureau of Ocean Energy Management and the Bureau of Safety and Environmental Enforcement.

which are pertinent to occupational or public health, safety or environmental protection, as may be requested.<sup>396</sup>

Under the regulations applicable at the time of the Macondo blowout, “operators” were the persons the lessee(s) designated as having control or management of operations on the leased area or a portion thereof. An operator could be a lessee, the MMS-approved designated agent of the lessee(s), or the holder of operating rights under an MMS-approved operating rights assignment. A “lessee” was a person who had entered into a lease with the United States to explore for, develop, and produce the leased minerals. The term “lessee” also applied to the MMS-approved assignee of the lease, and the owner or the MMS-approved assignee of operating rights for the lease.<sup>397</sup>

MMS was responsible for enforcing regulations governing drilling operations contained in 30 CFR Part 250. Subpart D covered many aspects of drilling operations, including permitting, casing requirements, cementing requirements, diverter systems, BOP systems, drilling fluids requirements, equipment testing, and reporting.<sup>398</sup> MMS regulations made clear that lessees, designated operators, and persons actually performing activities on the OCS were “jointly and severally responsible” for complying with any regulation that requires the lessee to meet a requirement or perform an action.<sup>399</sup>

#### A. *Permitting Process*

Prior to drilling a well or sidetracking, bypassing, or deepening a well, the operator had to obtain written approval from MMS. To obtain approval, the operator had to:

- (a) Submit the information required by 30 CFR § 250.411 through 250.418;
- (b) Include the well in its approved Exploration Plan (“EP”), Development and Production Plan (“DPP”), or Development Operations Coordination Document (“DOCD”);
- (c) Meet the oil spill financial responsibility requirements for offshore facilities as required by 30 CFR Part 253; and
- (d)

---

<sup>396</sup> 43 U.S.C. § 1348(b).

<sup>397</sup> See 30 CFR § 250.105.

<sup>398</sup> Subpart D applies to lessees, operating rights owners, operators, and their contractors and subcontractors. 30 CFR § 250.400. For ease of reference, this portion of the report will use “operator” to mean all of these entities, unless otherwise specified.

<sup>399</sup> 30 CFR § 250.146(c).

Submit the following forms to the District Manager: (1) An original and two complete copies of Form MMS-123, Application for a Permit to Drill (“APD”), and Form MMS-123S, Supplemental APD Information Sheet; (2) A separate public information copy of forms MMS-123 and MMS-123S that meets the requirements of 250.186; and (3) payment of the service fee listed in § 250.125.<sup>400</sup>

Upon receipt of the APD, MMS personnel reviewed it to determine whether it was complete, satisfied the relevant regulatory requirements and contained no errors. MMS personnel also assessed whether the applicant’s oil spill financial responsibility coverage was current.

MMS used a secure, electronic filing system called e-Well to process and review APDs. MMS district engineers were responsible for reviewing APDs submitted through the e-Well system. Review by a drilling engineer was done on a prioritized basis, depending on rig status and other factors.

MMS staff checked the proposed drilling rig’s maximum operating limits for drilling depth and water depth to ensure appropriateness for the proposed well program. The review included, but was not limited to, the proposed procedure, well location and directional program, geological and geophysical hazards, subsurface environment for pore pressure and fracture gradient, wellbore design and schematic, design calculations for pressure containment during drilling and completion, cement volumes, and testing pressures for the well control equipment, casing and casing shoe. This review was performed for shallow and deepwater drilling operations, and a hurricane risk assessment was performed during hurricane season.

MMS personnel reviewed APDs to determine whether the proposed operation satisfied 30 CFR § 250.420 by meeting the objective of safely reaching a targeted depth. This review included an assessment of: well casing setting depths determined by formation strength; predicted formation fluid pressure; drilling mud weight limits; any anticipated subsurface hazards; effectiveness of well casing strength for pressure containment at its specified depth; effectiveness of cementing the well casing after successfully securing and isolating the hydrocarbon zones or any encountered subsurface hazards; and maintaining

---

<sup>400</sup> 30 CFR § 250.410.

well control by adjusting drilling mud properties and the use of well control equipment such as diverters and BOP stacks.

The drilling engineer approved the APD on behalf of the District Manager after he or she reviewed the items listed above and after plan approvals were verified by the MMS Plans Unit. A MMS District Manager granted approvals of APDs, with all applicable cautions and conditions as necessary from the MMS Geological and Geophysical unit. If the APD did not satisfy all of the review items listed above, the drilling engineer returned the APD to the operator with comments documenting the deficiencies that need to be corrected prior to APD approval.

Operators routinely gathered information and formulated drilling programs that were much more detailed than the information required in the APD submitted to MMS. For example, the drilling prognosis submitted with the Macondo APD was condensed to a single page, while the full BP drilling program was more than 100 pages long.

If an operator changed drilling plans after submission of an APD, it was required to submit an “application for permit to modify” (“APM”).<sup>401</sup> The APM was required to include “a detailed statement of the proposed work that would materially change from the approved APD.”<sup>402</sup>

MMS’s Gulf of Mexico region was divided into five districts. The Macondo well is located in the Mississippi Canyon Block 252, which is covered by the New Orleans District. Frank Patton, an MMS drilling engineer in the New Orleans District, approved the Macondo APD on behalf of David Trocquet, the New Orleans District Manager.

The Panel found that Patton did not recognize that BP failed to submit supporting documentation that the blind shear ram in the BOP stack had the ability to shear the drill pipe in the hole under maximum anticipated surface pressures per 30 CFR § 250.416(e). However, the Panel reviewed evidence that Cameron and Transocean both determined, prior to the APD submittal, that the *Deepwater Horizon* BOP stack had the ability to shear the drill pipe in use.

---

<sup>401</sup> 30 CFR § 250.465.

<sup>402</sup> *Id.* When APMs are submitted through the e-well system to revise the permit to drill, they are submitted as a “revised permit to drill” (“RPD”). BP submitted its revised permit to drill through the e-well system.

Patton also approved the APMs and RPDs that BP submitted to MMS for the Macondo well, including the APMs related to BP's temporary abandonment of the well. BP submitted the last APM on April 16 and provided an overview of BP's planned temporary abandonment procedures. BP stated its intent to set a cement plug at a depth of 8,367 feet to 8,067 feet, and explained that it needed to set the plug deeper to minimize the chances of damaging the lock-down sleeve. Patton testified that he was not aware of evidence of any problems with the Macondo well and that he believed that BP had met all applicable regulatory requirements in submitting the APD the APMs, and the RPDs.<sup>403</sup> The Panel concluded that Patton's review and approval of the APD was not a cause of the Macondo blowout.

### ***B. Well Activity Reports***

After receiving MMS approval of an APD, pursuant to 30 CFR § 250.468(b), the designated operator had to submit a weekly Well Activity Report ("WAR") to the agency to report all of the specific operations at the well. The operator had to submit the WAR into e-Well weekly from the well's spud (start) date to the end of drilling operations at the well. The drilling engineer reviewed the WAR for consistency with the reviewed permit and to identify any anomalies that warrant possible revisions to the permit or issuance of incidents of noncompliance with the regulations. The WAR did not provide real time information, rather, it was a snapshot of the prior seven days' activities. The MMS drilling engineers who reviewed the WARs on the Macondo well, Patton and Peter Botros, noted no deficiencies on the WARs during the drilling of the Macondo well.

### ***C. Macondo Departures and Alternative Procedures***

In the APD process, operators could seek authorization from MMS to depart from the drilling requirements set out in 30 CFR Part 250.<sup>404</sup> MMS could also allow operators to conduct alternative procedures if those procedures are deemed to be safer or as safe as the requirements set forth in 30 CFR Part 250. MMS granted multiple requests for departures and alternative procedures at the Macondo well in the Macondo APD (*see* Appendix I). The Panel found that these

---

<sup>403</sup> Testimony of Frank Patton, Joint Investigation Hearing, May 11, 2010, at 268-69.

<sup>404</sup> *See* 30 CFR § 250.142; 30 CFR § 250.409.

departures from the regulations or alternate procedures were not a cause of the Macondo blowout.

#### ***D. MMS Drilling Inspections***

An MMS drilling inspection routinely involved a review of required documents and records, a walk-through visual inspection of the facility, and testing of equipment. Records reviewed during a typical inspection included: surveys; safety device information; records of BOP tests and inspections; records of diverter tests; records of well control drills; documentation of maximum pressures handled by the BOP stack; records reflecting the condition of the drilling mud; formation integrity test results; records of leak-off tests; applications; permits; and any evidence of unreported pollution incidents.

Visual inspections typically included a visual assessment of: the diverter system; classified drilling fluid handling areas; housekeeping and general safety conditions; safety valves on the rig floor; conditions of man-lift and air-hoist wire ropes; safe welding area and equipment in the area (to ensure the absence of flammable material); grounding of electrical buildings and equipment; emergency shutdown for diesel engines (air shut off); and operable BOP remote control stations.

MMS inspectors tested the following equipment during a typical inspection: crown block safety device; backup BOP accumulator charging system; degasser function; mud pit level alarms; flow show alarm; gas detection system; ventilation system and alarms; and mudlogger shack alarms. During the inspections of drilling rigs, MMS inspectors were not required to function-test the emergency disconnect systems, lower marine riser packages, or BOP stack secondary control systems.

#### ***E. Potential Incident of Noncompliance Guidelines***

To ensure consistency in the agency's inspection program, MMS inspectors performed OCS inspections using a national checklist called the Potential Incident of Noncompliance ("PINC") list. This list is a compilation of yes/no questions derived from safety, environmental and regulatory requirements relating to oil and gas operations on the OCS.

Upon detecting a violation, the MMS inspector issued an Incident of Noncompliance ("INC") to the operator and used one of three main enforcement

actions (warning, component shut-in, or facility shut-in), depending on the severity of the violation. If the violation was not severe or threatening, a warning INC was issued. The violation had to be corrected within a reasonable amount of time, which was specified on the warning INC. The shut-in INC could be for a single component (a portion of the facility) or the entire facility. The violation had to be corrected before the operator was allowed to continue the activity in question.

In addition to the enforcement actions specified above, MMS could assess a civil penalty of up to \$35,000 per violation per day if: 1) the operator failed to correct the violation in the reasonable amount of time specified on the INC; or 2) the violation resulted in a serious harm or damage, or a threat of serious harm or damage to human life, property or the environment.<sup>405</sup>

Figure 13 presents an example of PINC guidance about subsea BOP stacks can be found below:

|              |  |
|--------------|--|
| <b>D-253</b> | <p><b>ARE SURFACE AND SUBSEA BOP SYSTEMS PRESSURE TESTED BETWEEN WELLS, BEFORE DRILLING OUT EACH STRING OF CASING OR LINER, OR AS OTHERWISE APPROVED BY THE DISTRICT MANAGER?</b></p> <p><b>Authority:</b> 447(c) <span style="float: right;"><b>Enforcement Action:</b> W/S</span></p> <p><b>INSPECTION PROCEDURE:</b></p> <ol style="list-style-type: none"> <li>1. Inspect driller's report to verify that the tests were conducted between wells, before drilling out after each string of casing or liner.</li> <li>2. If tests are performed during inspection, witness the tests.</li> </ol> <p><b>Note:</b> This test can be omitted if approved in the APD.</p> <p><b>IF NONCOMPLIANCE EXISTS:</b></p> <p>Issue a warning (W) INC if the BOP Systems are not tested between wells or the casing shoe has been drilled out without testing and subsequent tests were performed.</p> <p>Issue a rig shut-in (S) INC if:</p> <ol style="list-style-type: none"> <li>1. Casing has been set and Operator is preparing to drill out without performing tests.</li> <li>2. A subsequent test has not been performed.</li> </ol> <p><b>INSPECTION COUNT/ INC COUNT:</b></p> <p>Enter one item checked/ issue one INC for each well inspected</p> |
|--------------|--|

Figure 13 – Example of National PINC Guidance for Drilling Inspection

The Panel determined that there was no PINC on the inspectors' checklist for 30 CFR § 250.446(a) at the time of the Macondo blowout. That provision requires an operator to conduct a major inspection of BOP stack components every three to five years. Because no PINC existed for this requirement, MMS inspectors did not regularly verify that the major inspection requirements had been met during drilling inspections.

---

<sup>405</sup> 43 U.S.C. § 1350(b); 30 CFR §§ 250.1403 - .1404. For violations that occur after July 30, 2011, the maximum civil penalty per day will be \$40,000 per day per violation.



## F. *Inspection Forms*

MMS inspections of drilling rigs involved a complete inspection as set out in a PINC list – which was, as described in the previous section, used as a checklist of items that inspectors checked during an inspection.<sup>406</sup> The PINC list was not a comprehensive list of all potential violations.

Inspectors recorded certain information on an inspection form, including identifying data about the rig, lease and operator, but they did not record what testing was conducted during the inspection, unless a violation was identified.<sup>407</sup> All information on INCs issued as a result of inspections was captured in a central MMS database, regardless of whether the district's inspection forms were originally in electronic or paper form. The Panel found that not all MMS districts used the same inspection form, and that the forms varied in length across the districts.

## G. *MMS Deepwater Horizon Inspections at MC 252*

While the *Deepwater Horizon* was on location at MC 252, MMS performed three drilling inspections on the rig. These inspections occurred on February 17, March 3, and April 1. MMS inspectors, Bob Neal and Eric Neal, identified no major deficiencies and issued no INCs during these inspections.

The last inspection was completed by Eric Neal, an inspector who had been with the agency since 2003. Even though Neal had previously participated in 73 drilling inspections, he testified that he was “[o]nly in training” for drilling inspections.<sup>408</sup> During the last inspection of the *Deepwater Horizon*, Neal used the PINC guidelines to assist him during his inspection and found no basis to issue any INCs.<sup>409</sup> The Panel found no evidence that the MMS inspections of the *Deepwater Horizon* conducted in 2010 were incomplete. The Panel found no evidence that the MMS inspections of the *Deepwater Horizon* while on location at Macondo were a cause of the blowout.

---

<sup>406</sup> Testimony of Robert Neal, Joint Investigation Hearing, May 11, 2010, at 350-351; Testimony of Eric Neal, Joint Investigation Hearing, May 11, 2010 at 326.

<sup>407</sup> Eric Neal testimony at 326-329; 334-336.

<sup>408</sup> Eric Neal testimony at 316.

<sup>409</sup> *Id.* at 325, 336.

## *H. Safe Drilling Margin*

MMS regulations required that “[w]hile drilling, you must maintain the safe drilling margin identified in the approved APD [Application for Permit to Drill]. When you cannot maintain this safe margin, you must suspend drilling operations and remedy the situation.”<sup>410</sup> The safe drilling margin referenced in the regulation is the difference between the fracture gradient and the mud weight. The regulation did not define “safe drilling margin,” but typically, the industry-accepted safe drilling margin was 0.5 ppg. This drilling margin was considered sufficient to allow the rig crew to circulate out a kick during the drilling process.

### *I. Well Control*

30 CFR § 250.401 requires an operator to take necessary precautions to keep the well under control at all times. This provision identified five specific well control requirements:

- Use the best available and safest drilling technology to monitor and evaluate well conditions and to minimize the potential for the well to flow or kick;
- Have a person onsite during drilling operations who represents the lessee’s interest and can fulfill the lessee’s responsibilities;
- Ensure that the toolpusher, operator’s representative, or a member of the drilling crew maintains continuous surveillance on the rig floor from the beginning of drilling operations until the well is completed or abandoned, unless the operator has secured the well with BOPs, bridge plugs, cement plugs, or packers;
- Use personnel trained according to the provisions of Subpart O of 30 CFR Part 250; and
- Use and maintain equipment and materials necessary to ensure the safety and protection of personnel, equipment, natural resources, and the environment.<sup>411</sup>

30 CFR Part 250 Subpart O regulations governing well control and production safety training require operators to establish and implement training programs that train employees to competently perform their assigned well

---

<sup>410</sup> 30 CFR § 250.427(b).

<sup>411</sup> 30 CFR § 250.401.

control duties.<sup>412</sup> MMS could evaluate operator well control training programs by auditing the operator's training program, conducting written and hands-on testing, witnessing well control drills, and other methods.<sup>413</sup>

Prior to August 2000, the regulations regarding well control training were prescriptive. The rule prescribed the content of the well control training curriculum and the length of the training class that each individual was required to complete according to responsibilities. Additionally, MMS required that all well control training providers needed to be approved by MMS.

In August 2000, MMS promulgated a performance-based rule that required lessees to develop and implement their training programs. This regulation, which became effective on October 13, 2000, required each operator to prepare a training plan laying out the company's training philosophy including the type, method, length, frequency and content of its training program. Under this rule, MMS did not review and approve the training providers nor did it specify the content of the training program. Rather, the lessee/operator was responsible for determining the content, length, and frequency of training programs.

Since implementing this performance-based approach, MMS has used a series of measures to periodically assess the quality of operator and contractor training programs. Such assessments have included a review of operator training plans, records, and methods. MMS has also reviewed the ways in which operators verified the training conducted by contractors.

After the Macondo blowout, BOEMRE reviewed BP's training plan, on-line training records, the methods by which BP evaluated Transocean and the methods by which BP verified that contract personnel were trained. BOEMRE also reviewed the contractor evaluation of Transocean. BP required all individuals with well control responsibilities (both BP employees and contractor employees) to be trained every two years. BOEMRE reviewed the training records of all drilling personnel stationed on the *Deepwater Horizon* and all BP personnel who had well control responsibilities. The Panel concluded that BP's

---

<sup>412</sup> 30 CFR § 250.1503.

<sup>413</sup> 30 CFR § 250.1507.

training program complied with 30 CFR Part 250 Subpart O and that Transocean's training program met the stipulations dictated by BP.<sup>414</sup>

BP, however, did not require the mudloggers monitoring the rig data to be trained in well control, and such training is not required by Subpart O. The mudloggers on in the *Deepwater Horizon* were employees of Sperry-Sun, a subsidiary of Halliburton. Halliburton has a well control training program for its own personnel, but its training program did not require mudloggers to be trained in well control operations, including kick detection.<sup>415</sup>

As noted previously in this Report, the Panel found evidence that BP, Transocean, and Halliburton violated 30 CFR § 250.401 by failing to take necessary precautions to keep the Macondo well under control at all times. As provided in 30 C.F.R. § 250.146, operators and contractors are jointly and severally liable for the failure to comply with all applicable regulations.

## ***J. Subsea BOP Regulatory Requirements***

MMS regulations established certain requirements related to BOP stack maintenance, testing, recordkeeping and inspections. Some of these regulations incorporated by reference API Recommended Practices ("RP"), which meant that compliance with an incorporated API RP was required as directed by the regulation.<sup>416</sup> This section discusses relevant MMS regulations in place at the time of the blowout.

### ***1. General BOP Requirements***

30 CFR § 250.440 required operators to design, install, maintain, test and use the BOP system and system components to ensure well control. The working-pressure rating of each BOP component had to exceed maximum anticipated surface pressures. The BOP system includes the BOP stack and associated BOP systems and equipment. BP calculated the Macondo well maximum anticipated surface pressure ("MASP") to be 6,153 psi using the well's estimated pore pressure at the well's planned total depth of 20,200 feet. BP also

---

<sup>414</sup> The Panel makes recommendations to improve the regulations at 30 CFR 250.1500 (Subpart O) relating to well control training.

<sup>415</sup> BP-HZN-MBI00328704.

<sup>416</sup> 1 CFR § 51.9(b)(3).

calculated the maximum anticipated wellhead pressure (“MAWP”) at the mudline (or BOP) was 8,404 psi.<sup>417</sup>

## 2. *Required Systems and Equipment*

If an operator opted to use a subsea BOP stack, it had to fulfill the MMS requirements set forth in 30 CFR § 250.442. The requirements were:

- The operator had to install the BOP system before drilling below surface casing.
- The subsea stack had to include at least four remote-controlled, hydraulically operated BOPs consisting of an annular BOP, two BOPs equipped with pipe rams, and one BOP equipped with blind shear rams.
- The operator had to install an accumulator closing system to provide fast closure of the BOP components and to operate all critical functions in case of a loss of the power fluid connection to the surface. The accumulator system had to meet or exceed the provisions of Section 13.3 in API RP 53, Recommended Practices for Blowout Prevention Equipment Systems for Drilling Wells.
- The BOP system had to include an operable dual-pod control system to ensure proper and independent operation of the BOP system.
- Before removing the marine riser, the operator had to displace the riser with sea-water. The operator had to maintain sufficient hydrostatic pressure or take other suitable precautions to compensate for the reduction in pressure and to maintain a safe and controlled well condition.

Additionally, all subsea BOP systems were required to meet the conditions set forth in 30 CFR § 250.443. This regulation required all systems to include:

- An automatic backup to the primary accumulator-charging system;
- At least two BOP control stations (one station on the drill floor and the other in a readily accessible location away from the drill floor);
- Side outlets on the BOP stack for separate kill and choke lines;
- A choke and kill line on the BOP stack (each to have two full opening valves, and both to be remote-controlled if it is subsea). The choke line

---

<sup>417</sup> BP’s April 15, 2010 APD.

had to be installed above the bottom ram, the kill line could be installed below the bottom ram;

- A fill-up line above the uppermost BOP;
- Locking devices installed on the ram-type BOPs; and
- A wellhead assembly with a rated working pressure that exceeds the maximum anticipated surface pressure (MASP).<sup>418</sup>

### 3. *Required Maintenance and Inspections*

30 CFR § 250.446 identified BOP stack maintenance and inspection requirements. This provision required maintenance of BOP systems to ensure that the equipment functioned properly. It also required to visual inspections of the subsea BOP system and riser at least once every three days if weather and sea conditions permitted. Subsea BOP stack maintenance was required to meet or exceed API RP 53 Sections 18.10, 18.11 and 18.12.

#### *a. API RP 53 Section 18.10*

Section 18.10 of API RP 53 generally prescribed recommended practices for well inspections and maintenance and required that all leaks and malfunctions were corrected before BOP equipment was placed into service. API RP 53 Section 18.10.3 recommended a “major inspection” of the BOP stack after every three to five years of service. During the major inspection, the BOP stack, choke manifold, and diverter components were recommended to be disassembled and inspected in accordance with the manufacturer’s guidelines.<sup>419</sup>

#### *b. API RP 53 Section 18.11*

Section 18.11.3 of API RP 53 addressed BOP maintenance. Of particular relevance here, Section 18.11.3 required that spare parts be designed for intended use. The operator was required to consult the original equipment manufacturer regarding replacement parts, and if parts were acquired from a non-original equipment manufacturer, “the parts shall be equivalent to or superior to the original equipment and be fully tested, design verified, and supported by traceable documentation.”<sup>420</sup>

---

<sup>418</sup> The JIT concluded that the current 30 CFR § 250.443 contains an error; it believes that this provision should refer to maximum allowable working pressure (MAWP), not MASP.

<sup>419</sup> API RP 53, Section 18.10.3.

<sup>420</sup> API RP 53, Section 18.11.3.

The Panel found no evidence that BP consulted with Cameron about modifying the BOP stack with parts from a non-original equipment manufacturer.

*c. API RP 53 Section 18.12*

Section 18.12 of API RP 53 required a lessee to have on each rig a “planned maintenance system, with equipment identified, tasks specified, and the time intervals between tasks stated.” Maintenance and repair records were required to be retained on file at the rig site or readily available.

*4. BOP Pressure Tests*

30 CFR § 250.447 required the operator to pressure test the BOP system (choke manifold, valves, inside BOP, and drill-string safety valve):

- When installed;
- Before 14 days elapsed since the last BOP pressure test; and
- Before drilling out each string of casing or a liner.<sup>421</sup>

While performing a 14-day BOP pressure test, the operator was required to comply with 30 CFR § 250.448. This regulation required the operator to conduct both a low-pressure and a high-pressure test for each BOP component. The low-pressure test had to be conducted before the high-pressure test. Each individual test had to hold pressure for five minutes. Examples of approved tests were:

---

<sup>421</sup> The MMS District Manager had the option to allow lessees to omit the last testing requirement if they did not remove the BOP stack to run the casing string or liner and if the required BOP test pressures for the next section of the hole were not greater than the test pressures for the previous BOP pressure test.

|  |   |
|--|---|
| Low-pressure Test  | Between 200 and 300 psi   |
| High-pressure Test for ram-type BOPs, the choke manifold, and other BOP components | Rated working pressure of equipment; or<br>500 psi greater than the calculated MASP for the applicable hole section (with MMS approval of those test pressures) |
| High-pressure Test for annular-type BOPs   | 70-percent of the rated working pressure of the equipment; or a pressure approved in the APD  |

Figure 14 – BOP Pressure Tests

If the equipment failed to hold the required pressure during any of these tests, the operator was required to correct the problem and retest the affected component.

#### 5. *Additional BOP Tests*

At the time of the blowout, the regulation included additional subsurface BOP testing requirements, including the following:

- Stump test of a subsea BOP system with water before installation;
- Alternate test between control stations and pods;
- Pressure test of the BSR during stump test and at all casing points;
- An interval between any BSR pressure test not exceeding 30 days;
- A pressure test of test variable bore-pipe rams against the largest and smallest sizes of pipe in use, excluding drill collars and bottom-hole tools;
- A pressure test of affected BOP components following the disconnection or repair of any well-pressure containment seal in the wellhead or BOP stack assembly;
- A function test of annulars and rams every seven days between pressure tests; and
- Actuation of safety valves assembled with proper casing connections before running casing.



## 6. *BOP Recordkeeping*

30 CFR § 250.450. required lessees to record the time, date and results of all pressure tests, actuation and inspections of the BOP system in the driller's report. The lessee was also required to:

- Record BOP test pressures on pressure charts;
- Require onsite representation to sign and date BOP test charts and reports as correct;
- Document the sequential order of BOP and auxiliary equipment testing and the pressure duration of each test (subsea BOPs record closing times for annular and ram BOPs);
- Identify the control station and pod used during the test;
- Identify any problems or irregularities observed during BOP system testing and record actions taken; and
- Retain all records at the facility for the duration of drilling the well.

Additionally, operators had to maintain complete and accurate records of all well activities including records of any significant malfunction or problem.<sup>422</sup>

### *K. Regulatory Improvements*

At the time of the Macondo blowout, MMS did not have a comprehensive set of regulations specifically addressing deepwater technology, drilling, or well design. Regulations applicable at that time to both shallow water and deepwater drilling operations were captured in 30 CFR §§ 250.400-490 (Subpart D).

As drilling operations have moved into deeper water, operational issues have become far more complex. This increased complexity demands appropriate regulatory improvements. The Panel concluded that the regulations in effect at the time of the Macondo blowout could be strengthened in a number of ways and that regulatory improvements may have decreased the likelihood of the Macondo blowout.

The Recommendations section of this Report contains a number of proposed regulatory improvements that the Panel believes would address the following areas: cement barriers in high flow potential wells; negative test procedures; specific cementing requirements; guidance on lock-down sleeve

---

<sup>422</sup> 30 CFR § 250.466.

installation; dynamic flow testing of BOP stacks; guidance on ram configuration on BOP stacks; and improvements in a number of BOEMRE inspection practices.

### *L. Incidents of Non-Compliance*

During its investigation, the Panel found evidence that BP, and in some instances its contractors, violated the following regulations in effect at the time of the blowout:<sup>423</sup>

- 30 CFR § 250.107 – BP failed to protect health, safety, property, and the environment. BP did not: (1) perform all operations in a safe and workmanlike manner; or (2) maintain all equipment and work areas in a safe condition.
- 30 CFR § 250.300 – BP, Transocean, and Halliburton (Sperry Sun) did not prevent conditions that posed unreasonable risk to public health, life, property, aquatic life, wildlife, recreation, navigation, commercial fishing, or other uses of the ocean.
- 30 CFR § 250.401 – BP, Transocean, and Halliburton (Sperry Sun) failed to take necessary precautions to keep the well under control at all times.
- 30 CFR § 250.420(a)(1) and (2) – BP and Halliburton did not cement the well in a manner that would properly control formation pressures and fluids; and prevent the direct or indirect release of fluids from any stratum through the wellbore into offshore waters.
- 30 CFR § 250.427(a) – BP failed to use pressure integrity test and related hole-behavior observations, such as pore pressure test results, gas-cut drilling fluid, and well kicks to adjust the drilling fluid program and the setting depth of the next casing string.
- 30 CFR § 250.446(a) – BP and Transocean failed to maintain the BOP system in accordance to API RP 53 section 18.10 and 18.11.

---

<sup>423</sup> This list of violations is based upon the evidence gathered by the JIT during its investigation and upon the Panel's findings and conclusions. Additional evidence may reveal further violations. After this Report is released, BOEMRE will issue Incidents of Non-Compliance based upon evidence contained in this Report and/or other relevant evidence.

- 30 CFR §1721(a)– BP failed to conduct the negative test on April 20 in accordance with the negative test procedure approved in the April 16 APM.

## XV. Policies and Practices of Involved Companies

### A. *BP's Policies and Practices*

The Panel's investigation found that, at the time of the blowout, BP had a number of carefully documented policies and practices addressing drilling operations, change management, safety and risk management.

According to BP, during 2010 it was in the process of implementing a comprehensive, company-wide approach to management called the Operating Management System ("OMS"). OMS was and is intended to "provide a standardized approach that promotes effective and consistent risk management across the company."<sup>424</sup>

Under BP's OMS, local business units are responsible for implementing their own OMS. BP's drilling and completions unit in the Gulf of Mexico issued its local OMS in November 2009.<sup>425</sup> Gulf of Mexico drilling operations are also guided by BP's DWOP manual and its "Beyond the Best" manual. BP drilling operations must also follow the Company's "golden rules" of safety.

#### 1. *BP's Risk Assessment Policies*

BP has recognized that "[t]he identification and mitigation of operating risk is a key element of OMS" and has touted a number of its risk assessment and management tools.<sup>426</sup> In January 2009, BP issued a company standard on assessment, prioritization and management of risk (January 2009 standard). This document recognizes that "[i]nconsistent or ineffective identification and assessment of risk to health and safety of people, the environment and operating performance can create many issues for the organization."<sup>427</sup> The stated purpose of issuing the January 2009 standard was to "provide a consistent approach to risk management to target resources most effectively for continuous risk reduction."<sup>428</sup>

---

<sup>424</sup> BP Submittal to the National Commission on the BP Deepwater Horizon Oil Spill and Offshore Drilling, entitled "BP's Commitment to Safety" ("BP Commitment to Safety Submission").

<sup>425</sup> BP-HZN-MBI00208572.

<sup>426</sup> BP Commitment to Safety Submission.

<sup>427</sup> BP-HZN-MBI00195284.

<sup>428</sup> *Id.*

The January 2009 standard provides that each BP facility maintain a risk register that contains a description of identified risks and the development of an action plan to manage those risks. It also makes clear that BP entities should seek to identify where the workforce may have become accustomed to the presence of the risk, or to weaknesses in safety controls.<sup>429</sup>

Former BP executive vice president, James “Kent” Wells summarized the company’s OMS system as follows:

We have a number of systems. DWOP, for one, gives us guidance. We have a system that we've been working on for the last several years called OMS, which is our operational management system.

And the purpose of that system is to sort of bring together so we're very systematic and consistent across the whole company the way we expect things to be done. And it sets out - - we have some standards in there.

And what we do is we use that to set the guidelines for activity we might do, and then also to work with our contractors that probably already have their own safety management systems to make sure that we believe their systems are adequate.<sup>430</sup>

As noted by Wells, the requirements in the January 2009 standard were supplemented by requirements in the DWOP. BP’s DWOP required that BP employees be present at every well site and that there be adequate procedures in place to ensure safe drilling operations.

BP’s DWOP also covered the management of risk. Specifically, it provided that “[a]ll [drilling and completion] operations shall follow a documented and auditable risk management process to include identification, assessment, prioritization and action.”<sup>431</sup> The DWOP required specific documentation and stated that the recommended tool for documenting and managing drilling and completions risk was a web-based tool called the BP risk assessment tool (RAT).

---

<sup>429</sup> BP Commitment to Safety Submission.

<sup>430</sup> Testimony of James Wells, Joint Investigation Hearing, August 26, 2010, at 23-24.

<sup>431</sup> BP-HZN-MBI00130820.

The Panel's investigation found that BP drilling engineers did not evaluate or communicate the ongoing risk associated with the following:

- The production casing shoe was set in a laminated sand-shale interface in lieu of a consolidated shale;
- Deciding not to set an additional production casing barrier, such as, setting a retainer and/or cement plug above the float collar;
- Substantial (greater than 3,000 bbls) mud losses had occurred in the open-hole production interval, which indicated potential cementing problems;
- The planned positive testing of the casing would have only tested the top wiper plug and not the cement casing track below the plug;
- The float collar was not a mechanical barrier to well flow;
- No cement was left above the float collar so that there would be enough room to run a cement evaluation log; the log was never run;
- The M56A and M56E sands were potentially unstable because of a difference in pore pressures; and
- There was a potential for ballooning in the open-hole production interval from 17,168 feet to 18,360 feet.

Instead of using the recommended risk assessment tool (the BP RAT system), the Macondo engineering team used a risk register, which was a spreadsheet that the team created to anticipate risks and to identify individuals assigned to mitigate risks.

John Guide testified that a register or "ledger" was used throughout the process of drilling the well.<sup>432</sup> The Macondo team did not perform any risk analyses (or mitigation analyses) using the risk register after June 20, 2009.<sup>433</sup> Thus, the risk register was only utilized during the Macondo well design phase and not during BP's execution of day-to-day operations at the well.

In the risk register, BP personnel identified 23 risks while planning the well. BP personnel placed these risks into only three different categories – cost, production and schedule – and chose not to categorize any of them as "health and safety" risks. For example, BP personnel identified a well control problem as a "cost" and not a "health and safety" risk. The risk categories available in the

---

<sup>432</sup> Guide testimony, July 22, 2010, at 64.

<sup>433</sup> BP-HZN-MBI 00269180; *see* Appendix J.

risk register were: health and safety, environmental, reputation, cost, schedule, production, reserves, and net present value.

Another example of the failure of the Macondo team to fully assess risks was its decision to only use six centralizers (as discussed in Section I). In email about this decision, Brett Cocolis wrote:

But who cares, it's done, end of story, we'll probably be fine and we'll get a good cement job. I would rather have to squeeze than get stuck above the WH. So Guide is right on the risk/reward equation.<sup>434</sup>

Cocolis testified that the "risk/reward equation" did not have a specific meaning within BP.<sup>435</sup> The Panel found no evidence reflecting a BP risk/reward calculation on the decision of how many centralizers should be used in the well design.

The Panel found that in the weeks leading up to the blowout on April 20, the BP Macondo team made a series of operational decisions that reduced costs and increased risk. The Panel did not find any explicit statements by BP personnel that any of these decisions were made as part of a conscious cost/risk trade-off. However, the evidence the Panel reviewed suggests that the Macondo team made a series of decisions that cut costs and saved time. Moreover, the Panel found no evidence that the cost-cutting and time-saving decisions were subjected to the various formal risk assessment processes that BP had in place (e.g., risk register, BP RAT, etc.). Examples of such decisions are contained in the below chart:

---

<sup>434</sup> BP-HZN-MBI00128409.

<sup>435</sup> Cocolis testimony at 24.

| <b>BP Decision</b>  | <b>Less Cost to BP</b> | <b>Less Rig Time</b> | <b>Greater Risk</b> |
|---|------------------------|----------------------|---------------------|
| 6 versus 21 Centralizers  | Yes                    | Yes                  | Yes                 |
| Cement Bond Log   | Yes                    | Yes                  | Yes                 |
| Full Bottoms Up on 4/19   | Yes                    | Yes                  | Yes                 |
| Long String versus Liner  | Yes                    | Yes                  | --                  |
| Timing of Lock Down Sleeve Installation After the Negative Test | Yes                    | Yes                  | Yes                 |
| Pumping mud to boat while displacing                            | Yes                    | Yes                  | Yes                 |
| Lost circulation material ("LCM") pills combined for Spacer     | Yes                    | Yes                  | Unknown             |

Figure 15 – BP Decisions and Associated Cost, Time and Risks

## 2. Management of Change – Drilling Operations

BP's DWOP required that any significant changes to a drilling plan "shall be documented and approved via a formal management of change ("MOC") process."<sup>436</sup> This requirement was reinforced by the BP golden rules, which require that "work arising from temporary and permanent changes to organization, personnel, systems, process, procedures, equipment, products, materials of substances, and laws and regulations cannot proceed unless a MOC process is completed." BP required the MOC process to include: (1) a risk assessment conducted by all affected by the change; (2) a work plan that included details regarding control measures to be implemented for equipment, facilities, process, operations, maintenance, inspection, training, personnel, communication, and documentation; and (3) authorization of the work plan by responsible person(s).<sup>437</sup>

Despite the company's careful documentation of the importance and necessity of the MOC process, the Macondo team did not use this process to manage important changes occurring in day-to-day drilling operations. Examples of MOC issues that were not properly documented or completed in accordance with BP policy during drilling operations included:

---

<sup>436</sup> BP DWOP 4.4.

<sup>437</sup> *Id.*



- During April 14-19, 2010, BP made a number of casing design changes, but corresponding MOC documents were never formally completed. Gregg Walz agreed in his testimony that this was a “clerical error.”<sup>438</sup>
- The casing design changes for the Macondo well were submitted to MMS for approval prior to completion of the MOC process.<sup>439</sup>
- The following operational changes were not subjected to the type of risk analyses required by BP’s MOC policy:
  - (1) Rig procedure changes such as replacing the viscous spacer with a lost circulation material. The 450 barrel lost circulation material (M-I SWACO Form-A-Set and Form-A-Squeeze) with polymer viscosifier and weighting material added was highly thixotropic (resistant to initiate flow) and viscous. This would lead to a resistance to flow-in in the colder kill line (located outside the riser), which in turn would result in the suppression of pressure readings using the kill line for the negative test.
  - (2) The decision not to run the cement bond log lacked a proper risk evaluation because several factors were not considered such as the relatively small volume of foam cement pumped, insufficient centralization of the casing, and questionable conversion of the float collar.<sup>440</sup>

David Sims testified that, during 2010, BP was in the process of converting from a paper MOC process to an electronic process. He called the process a “gradual, painful process.”<sup>441</sup> Whether the members of the Macondo team were using the paper or electronic process, there is evidence that they were not following BP’s carefully crafted policies on operational changes. The team’s decision-making proceeded with few or no checks and balances. On April 17, just three days before the blowout, Guide stated in an email to Sims:

David, over the past four days there has [sic] been so many last minute changes to the operation that the WSL’s [Well Site Leaders] have finally

---

<sup>438</sup> Testimony of Gregg Walz, Joint Investigation Hearing, October 7, 2010, at 128.

<sup>439</sup> Sims testimony, August 26, 2010 at 147.

<sup>440</sup> BP did not appear to ignore the MOC process in all of its decisions. The panel found evidence that the casing design changes for the Macondo well were subject to an MOC analysis.

<sup>441</sup> Sims testimony at 165.

come to their wits end. The quote is “*flying by the seat of our pants.*” More over, we have made a special boat or helicopter run everyday. Everybody wants to do the right thing, but, this huge level of paranoia from engineering leadership is driving chaos. This operation is not Thunderhorse. Brian has called me numerous times trying to make sense of all the insanity. Last night's emergency evolved around the 30 bbls of cement spacer behind the top plug and how it would affect any bond logging (I do not agree with putting the spacer above the plug to begin with). This morning Brian called me and asked my advice about exploring opportunities both inside and outside of the company. What is my authority? *With the separation of engineering and operation, I do not know what I can and can't do. The operation is not going to succeed if we continue in this manner.* (emphasis added).<sup>442</sup>

### 3. Management of Change - Personnel Changes

BP had MOC policies related specifically to personnel changes. The requirements for personnel MOCs were identical to the requirements for operational change, requiring formal risk assessment, a work plan, and authorization. These policies applied to both temporary and permanent changes to the organization.

Notwithstanding the detailed personnel MOC requirements, BP appears to have given little consideration to who would temporarily replace Sepulvado as well site leader on the rig during temporary abandonment procedures. Sepulvado first notified Guide on February 26 of his upcoming well control training (scheduled for April 19 through April 24).<sup>443</sup> Sepulvado reminded Guide again on April 11 that he needed to find a temporary replacement well site leader while Sepulvado was out for training.<sup>444</sup>

Kaluza informed Guide on April 12 that he could cover for Sepulvado.<sup>445</sup> Due to his anticipated short tenure on the rig, Kaluza was not given all access rights to pertinent information within BP's own system.<sup>446</sup> Guide approved the replacement of Sepulvado with Kaluza on April 12 without reviewing Kaluza's performance evaluations. No one provided Kaluza with a detailed briefing on

---

<sup>442</sup> BP-HZN-MBI00255906.

<sup>443</sup> BP-HZN-MBI00171845.

<sup>444</sup> BP-HZN-MBI00171849.

<sup>445</sup> BP-HZN-MBI00171853.

<sup>446</sup> BP-HZN-MBI00171859.

problems that had been encountered during drilling operations at Macondo; nor was he given any MOC materials. Sepulvado sent Kaluza a short email on April 16 about rig operations – that was the only information Kaluza received from Sepulvado prior to starting as well site leader on the *Deepwater Horizon*.

Kaluza had four years of deepwater drilling experience, but no experience on the *Deepwater Horizon* and limited experience with Transocean operations. The Panel concluded that there was adequate time for Guide to find a more suitable replacement for Sepulvado or to perform a MOC prior to the date Kaluza took Sepulvado's place.

#### 4. *Job Transition and Handover Assurance*

BP required employees to complete a job transition and handover assurance form prior to permanent transfer from one job to another. The stated purpose of this form was “to assure a safe and seamless job transition,” and BP was supposed to use it “to certify that all accountabilities and expectations are clear and communicated to all involved and that all performance obligations are fulfilled.”<sup>447</sup>

As part of the job handover process, BP required that the “incumbent” and the “recipient” review and sign a completed form to certify the transfer of authority. BP's procedures stated that the team leader “*should* sign the form indicating that handover is complete” (emphasis added).<sup>448</sup> The job transition and handover assurance process steps contradicted BP's own golden rules of safety by leaving the review and signature optional. The Panel found evidence that three of the five job transition and handover assurance forms concerning the personnel changes in the months preceding April 20 were not fully completed in accordance with the instructions provided in the document.<sup>449</sup>

---

<sup>447</sup> BP-HZN-MBI00190164. The form included the following sections: accountabilities and expectations; transition process; business risks and critical areas of focus; health, safety, security and environment and crisis management; information transfer; people and organization; performance monitoring and reporting; external relationships; and communication.

<sup>448</sup> *Id.*

<sup>449</sup> During a 2010 reorganization, BP failed to follow its MOC process in the following ways: Kevin Lacy was replaced by Pat O'Bryan and four items were not checked completed and not signed (BP-HZN-MBI00190161); Brett Cocales' transition to engineering was not completed (BP-HZN-MBI00190128); and Harry Thierens' handover of wells director roles and accountabilities to Dave Rich was not completed (BP-HZN-MBI00190128).

## 5. *Communication Problems*

BP had a communication plan in place to alleviate some of the confusion about who should make decisions concerning rig operations and when such decisions should be made. According to the BP's communication plan, BP was responsible for all of the decisions being made on the *Deepwater Horizon*.

The communication plan depicted direct lines between the well site leaders and onshore personnel; and there were multiple daily meetings between BP personnel in Houston and personnel on the *Deepwater Horizon*. Nonetheless, the Panel found evidence that BP personnel in Houston did not transfer critical information to rig personnel. As noted previously in this Report, this communication failure, which resulted in the rig crew being unaware of increasing operational risks, may have created a false sense of security among those on the rig.

## 6. *Health and Safety*

The stated goal of BP's safety policy was "[n]o accidents, no harm to people and no damage to the environment." As referenced earlier in this Report, BP's safety rules (called the "golden rules") provided key controls and procedures with which the workforce must comply. BP's golden rules also required identifying the hazards and assessing the risks associated with the activities on a regular basis.

Kent Wells testified about BP's safety policies:

Well, so our belief around safety is that we need everyone feeling responsible for not only their own personal safety but the safety of the people around.

And so our – our policies and our procedures and our approach are sort of geared towards trying to create that safety culture so it's not where one person is trying to do it. We try to have everybody thinking about what are the hazards, what activity are we going on.

We have a policy of stopping the job. We hopefully make sure that every single employee out there knows that at any point they can stop the job

when they believe there's a hazard that we haven't addressed or there's a risk that needs to be dealt with.<sup>450</sup>

Notwithstanding BP's health and safety policies, as detailed earlier in this Report, the Panel found that the company conducted drilling operations at Macondo in a manner that increased the risks of the project.

### 7. Focus on Cost Savings

The Panel found evidence that BP personnel were compensated and their performance reviewed, at least in part, based upon their abilities to control or reduce costs. At some point in 2008, BP implemented an "every dollar counts" program that was focused on reducing costs by improving the efficiency of drilling operations.<sup>451</sup>

Performance evaluations reflected this cost-cutting focus. An "operational" performance measure for BP drilling personnel was delivering a well with costs under the authorized expenditure amount. There was no comparable performance measure for occupational safety achievements.

The Panel reviewed performance evaluations conducted in 2009 of 13 BP personnel involved in Macondo operations. These individuals had various different responsibilities on the Macondo project; however, these evaluations may not have been reflective of each person's positions on April 20, 2010, particularly given the number of reorganizations that occurred at BP. The Panel found that 12 of the 13 evaluations completed by BP personnel captured costs savings as a specific performance measure.

As mentioned previously in this Report, in the weeks leading up to April 20, the BP Macondo team made a series of operational decisions that reduced costs and increased risks. For example, when considering the lock-down sleeve installation on the Macondo well in January 2010, Mark Hafle and Merrick Kelley reviewed the \$2.2 million of incremental cost benefit to BP. Hafle discussed this further with Sims, and they agreed that BP should move forward with the lock-down sleeve installation after setting the surface cement plug and prior to the departure of the *Deepwater Horizon* from the Macondo well. This decision

---

<sup>450</sup> Wells testimony at 18.

<sup>451</sup> Guide testimony, October 7, 2010, at 141-43.

affected the procedure for the setting of the surface plug, the displacement, and the negative test sequence.<sup>452</sup>

On the day of the blowout, a BP contractor suggested making an additional wash run due to his concerns about achieving a successful lead impression tool impression.<sup>453</sup> Guide responded by saying “[w]e will never know if your million dollar flush run was needed. How does this get us to sector leadership(?)”<sup>454</sup>

The Panel found that a number of BP decisions were not subjected to a formal risk assessment process. In addition, the Panel found no evidence indicating that, at the time of the blowout, BP had in place any policy or practice to assess whether safe operations were being compromised to achieve cost savings.

## **B. Transocean’s Practices and Procedures**

### **1. Safety-Related Policies**

Transocean was responsible for the safe operation of the *Deepwater Horizon*. The company has touted its commitment to safety by pointing towards its “company-wide safety management programs and the intensive training regimen required of its rig crews.”<sup>455</sup>

According to Transocean’s health and safety policy statement, “each employee has the obligation to interrupt an operation to prevent an incident from occurring.”<sup>456</sup> During 2010, Transocean had an array of acronym-based safety programs that attempted to ensure safe rig operations (THINK, START, CAKE, FOCUS, and TOFS). Transocean designed these safety programs to allow rig personnel to identify hazards and stop work when necessary. The Panel found no evidence, however, that on April 20 anyone on board the *Deepwater Horizon* identified risks that would warrant shutting down operations.

Transocean’s “THINK” program was designed to increase awareness of safety issues through task planning, hazard identification and assessment of the

---

<sup>452</sup> BP-HZN-MBI0097490.

<sup>453</sup> BP-HZN-MBI00258505.

<sup>454</sup> BP-HZN-MBI00258507.

<sup>455</sup> See Submission of Transocean to the JIT (May 13, 2011), at 1.

<sup>456</sup> BP-HZN-MBI00001604.

likely consequences of a potential incident. The THINK program attempts to reduce risks through preventative and mitigating actions.<sup>457</sup> According to Transocean documents, “[t]he THINK process reminds personnel to think about everything they do before actually doing it.” . . . “THINK is used by the company to formulate and communicate the plan.” . . . “The THINK Planning Process is utilized for Risk Management of all activities and tasks carried out throughout the company.”<sup>458</sup>

Transocean’s “START” program was a related process that is defined as “See, Think, Act, Reinforce, and Track.” Transocean stated that the START process “monitor[ed] the operation and reinforce[ed] safe behavior, while correcting any unsafe acts or conditions, [and] is vital to ensure that the necessary controls remain in place during implementation. . . . START is used by the company to monitor the plan and recognize when the plan is no longer suitable.”<sup>459</sup>

“CAKES” was Transocean’s program for task planning. The acronym incorporates different rules using the words comply, authority, knowledge, experience, and skills.<sup>460</sup> Transocean’s “FOCUS” approach seeks to make consistent the execution of THINK and START across the organization.<sup>461</sup> TOFS (time out for safety) was Transocean’s stated policy that allowed tasks to be stopped (planned or unplanned) to ensure safe operations.<sup>462</sup>

None of these policies eliminated concerns about some members of the Transocean crew. The Panel found evidence that Paul Johnston, Transocean rig manager, questioned whether the Transocean members of the *Deepwater Horizon* crew were adequately prepared to independently recognize hazards. In a March 2010 email to Guide, Johnson offered a candid assessment of the rig crew and their abilities:

John, I thought about this a lot yesterday and asked for input from the rig and none of us could come up with anything we are not already doing or have done in the past with little success. There was a common theme from all though. Nothing takes the place of supervisor involvement to ask

---

<sup>457</sup> See Submission of Transocean to the JIT (May 13, 2011), at 2.

<sup>458</sup> BP-HZN-MBI00001764.

<sup>459</sup> BP-HZN-MBI00001626.

<sup>460</sup> BP-HZN-MBI00001769.

<sup>461</sup> BP-HZN-MBI00001627.

<sup>462</sup> BP-HZN-MBI00001770.

that question of the hands, in the THINK Plans, and to make them think for themselves and lead them in the right direction by mentoring them. You can tell them what the hazards are, but until they get used to identifying them themselves, they are only following your lead. I haven't given up on this and if I have an epiphany I will send you an email. Believe it or not when I am troubled or stumped I talked with my wife as she is a good listener and gets me headed in the right direction. Maybe what we need is a new perspective on hazard recognition from someone outside the industry.<sup>463</sup>

Johnson's assessment was reinforced by a March 2010 Lloyd's Register audit of Transocean, which found that "[Rig crews] don't always know what they don't know. Front line crews are potentially working with the mindset that they believe they are fully aware of all the hazards when it is highly likely that they are not."<sup>464</sup>

The Lloyd's audit also evaluated the *Deepwater Horizon* in March 2010 and found that there was a "strong team culture onboard *Deepwater Horizon* and the levels of mutual trust evident between the crews means that the rig safety culture was deemed to be robust, largely fair, and inclusive, which was contributing to a 'just culture.'"<sup>465</sup> This audit found that the rig crews' strengths were leadership, the workforce's influence on safety, the level of trust between the teams, and the provision of effective resources to support safe operations.<sup>466</sup>

But the same audit found weaknesses, including management of change and the complexity of some risk management procedures. While the majority of the crew was comfortable with identifying and understanding the hazards of their respective jobs, supervisors and rig leadership teams had concerns that:

- The workforce was not always aware of the hazards they were exposed to, relating to both their job and to other jobs being conducted in the same/adjoining work areas;
- THINK Plans did not always identify relevant major hazards related to that task;

---

<sup>463</sup> BP-HZN-MBI00225048.

<sup>464</sup> TRN-HCEC 90501.

<sup>465</sup> TRN-HCEC 90579.

<sup>466</sup> *Id.*



- The risks posed by identified hazards were not fully understood and the subsequent control measures were not always appropriate;
- Emerging hazards during task execution, and hazards with a changing risk level, were not always detected or fully appreciated; and
- “They don’t know what they don’t know.”<sup>467</sup>

This difference in awareness of hazards clearly demanded attention, as frontline crews were potentially working with a mindset that they believed they were fully aware of all the hazards when it is likely that they were not. If a crew is not aware of risks and hazards, it is less likely to be able to recognize unsafe situations and will not take immediate actions to mitigate risks.

Taken together, the audits and documentary evidence suggest that the *Deepwater Horizon* crew was generally effective and safety-conscious, but may not have had the tools, ability or opportunity to identify and mitigate hazards associated with rig operations.

## 2. *Transocean 21-day Hitch Policy*

In September 2009, Transocean revised its offshore employee hitch schedule from 14 to 21 days. The revision to the work schedules was partially due to a transportation schedule that would allow for fewer flights to and from the facilities. Seven of the 11 individuals who died onboard the *Deepwater Horizon* had been onboard for more than 19 days. The Panel, however, found no evidence that the Transocean hitch schedule affected rig personnel’s ability to perform their duties. See Appendix N.

## 3. *Transocean Incentive Awards*

Transocean had multiple bonus incentives, dependent upon level of employment (rig, division, rig managers). Variables of the bonus equations were: safety performance; individual performance; cash flow value added; in-service daily cost; rig downtime; lost revenue; and overhead cost.

Rig employees’ bonus incentives were based on 60% cost-related items, 20% safety performance and 20% individual performance. Division employees’ bonus incentives were weighed in the same way: 60% cost related items, 20% safety performance and 20% individual performance. Rig managers’ bonus

---

<sup>467</sup> TRN-HCEC 90501.

incentives were 50% “discretionary” factors, 37.5% cost related items and 12.5% safety performance.

The Panel found no evidence that decisions by Transocean personnel to defer rig maintenance and/or down time were directly rewarded with any type of bonus payment. However, Transocean’s policy of rewarding personnel based upon a number of different variables (e.g., down time, lost revenue, cash flow value added) when trying to maintain safe operations introduced conflicting priorities and created risks that operational decisions might compromise safety.

### ***C. BP and Transocean Bridging Document***

BP and Transocean developed a bridging document for operations associated with deepwater drilling in North America. It outlines the responsibility of both parties to ensure that health and safety management systems are in place, and that all operations are to be conducted in a safe manner. But the bridging document did not include procedures on well control, a crucial topic for safe drilling operations.<sup>468</sup> This was inconsistent with BP’s prescribed policies for safe drilling operations.<sup>469</sup>

### ***D. Stop Work Authority***

The *Deepwater Horizon* had multiple stop work policies in play on the day of the blowout. BP, Transocean and Halliburton personnel all had company-specific policies to stop work they deemed to be unsafe.

BP’s golden rules of safety state, “[e]veryone who works for or on behalf of BP is responsible for their safety and the safety of those around them.”<sup>470</sup> Transocean’s stop work authority states, “[e]ach employee has the obligation to interrupt an operation to prevent an incident from occurring.”<sup>471</sup> Halliburton’s hazard observation and communication policy states “[t]he HOC Card has been designed for use by all employees regardless of their position or their type or

---

<sup>468</sup> The Panel located stand-alone well control manuals within BP and Transocean; however, but no document bridging the two manuals together.

<sup>469</sup> Section 15.2.17 of BP’s DWOP requires that “a well control interface / bridging document shall be prepared with the appropriate contractor to ensure there is clear understanding of responsibilities and which reference documents and procedures will be used in a well control situation.”

<sup>470</sup> BP’s Golden Rules of Safety.

<sup>471</sup> BP-HZN-MBI00001604.

place of work. The philosophy of the company is that accidents can be prevented by breaking the chain of events that fit together to form an accident.”

All witnesses who testified before the Panel stated that they were aware of the stop work authority and their obligations towards safety. Nevertheless, no stop work authority was implemented on the day of the blowout despite the fact that the rig crew encountered numerous anomalies that might have caused such authority to be invoked.

## XVI. Conclusions Regarding Involved Companies' Practices

BP, Transocean and Halliburton each had "stop work" programs. The Panel found no evidence to suggest that the rig crew members were aware of the multiple anomalies that occurred on April 19-20. **The failure of the rig crew to stop work on the *Deepwater Horizon* after encountering multiple hazards and warnings was a contributing cause of the Macondo blowout.**

The Panel found no evidence that BP performed a formal risk assessment of critical operational decisions made in the days leading up to the blowout. **BP's failure to fully assess the risks associated with a number of operational decisions leading up to the blowout was a contributing cause of the Macondo blowout.**

Many of the decisions made leading up the *Deepwater Horizon* blowout – including the timing of the installation of the lock-down sleeve, the conducting of multiple operations during mud displacement, and the use of lost circulation material pills as spacer lowered the costs of the well and increased operating risks. These decisions were not subjected to a formal risk assessment. **BP's cost or time saving decisions without considering contingencies and mitigation were contributing causes of the Macondo blowout.**

Multiple decisions (the number of centralizers run, the decision not to run a cement evaluation, the decision not to circulate a full bottoms-up, and others) were in direct contradiction with the DWOP guidance to keep risk as low as reasonably practical. **BP's failure to ensure all risks associated with operations on the *Deepwater Horizon* were as low as reasonably practicable was a contributing cause of the Macondo blowout.**

As a prudent operator, BP should have complete control of operations and issues surrounding operations on its lease. Examples of items BP should have had control and responsibility over are:

- Maintenance of the *Deepwater Horizon*;
- General alarm configuration and operation;
- BOP 5-year major inspection requirements;
- BOP modifications; and
- Cement job.

**BP's failure to have full supervision and accountability over the activities associated with the *Deepwater Horizon* was a contributing cause of the Macondo blowout.**

As part of BP's operations integrity and risk management programs, BP developed a systematic, risk-based MOC to document, evaluate, approve and communicate changes to facilities, systems, process, procedures, organization, and personnel. The BP MOC process did not document certain critical changes, including:

- During April 14-19, 2010, several BP casing design changes occurred, yet multiple MOC documents were never officially completed due to a "clerical error."
- These casing design changes for the Macondo well were submitted to MMS for approval prior to the MOC being approved, according to testimony by Sims on August 26, 2010.
- During a reorganization in 2010, the responsibility shift from the drilling team leader (David Sims) to the drilling engineering team leader (Gregg Walz) was not properly completed.
- A MOC was not completed for the operations drilling engineer (Bret Cocales) in regard to his transfer to the BP drilling engineer team.
- Examples of BP's failure to conduct a proper risk analysis include:
  - (1) No formal MOC risk analysis document was completed for the well site leader transition from Sepulvado to Kaluza.
  - (2) Rig procedure changes, such as replacing the viscous spacer with lost circulation material, were not subjected to a formal risk analysis. The 450-barrel lost circulation material (M-I SWACO Form-A-Set and Form-A-Squeeze) with polymer viscosifier and weighting material added was highly thixotropic (resistant to initiate flow) and viscous. This would lead to a resistance to flow in the colder kill line (located outside the riser), resulting in the suppression of pressure readings using the kill line for the negative test.
  - (3) The decision not to run the cement bond log lacked a proper risk evaluation because several factors were not considered, such as the relatively small volume of foam cement pumped, insufficient centralization of the casing and questionable conversion of the float collar.

**BP's failure to document, evaluate, approve, and communicate changes associated with *Deepwater Horizon* personnel and operations was a possible contributing cause of the Macondo blowout.**

BP and Transocean had a bridging document that merged their respective safety programs. The bridging document did not address well control. BP and Transocean had stand-alone well control manuals, and the rig crew was trained and operated in accordance with Transocean's manual. **The failure of BP and Transocean to ensure they had a common, integrated approach to well control was a possible contributing cause of the Macondo blowout.**

BP required its employees and contractor personnel with well control responsibilities to be trained every two years in well control in accordance with BP's Subpart O plan. The Panel found that all personnel identified within BP's plan were trained in accordance with the BP Subpart O plan. The current Subpart O rule does not identify personnel who should have training in well control operations (including monitoring the well) beyond the personnel who are interfacing with the BOP stack and drill floor operations. **The failure of the current Subpart O rule to identify (by definition) personnel who need to be trained in well control operations, specifically in kick detection, was a possible contributing cause of the Macondo blowout.**

## **XVII. Summary of Panel Conclusions**

### **A. *Well Design and Cementing***

The Panel concluded that a combination of contamination, over-displacement, and possibly nitrogen breakout of the shoe cement were causes of the blowout.

The decision to set the production casing in a laminated sand-shale zone in the vicinity of a hydrocarbon interval was a contributing cause of the blowout.

With the known losses experienced in the well, BP's failure to take additional precautions, such as establishing additional barriers during cementing, was a contributing cause of the blowout.

BP and Halliburton's failure to perform the production casing cement job in accordance with industry-accepted recommendations as defined in API RP 65 was a contributing cause of the blowout.

BP's decision to set the float collar across the hydrocarbon-bearing zones of interest, instead of at the bottom of the shoe, was a contributing cause of the blowout.

BP's failure to inform the parties operating on its behalf of all known risks associated with Macondo well operations was a contributing cause of the blowout.

BP's failure to appropriately analyze and evaluate risks associated with the Macondo well in connection with its decision-making during the days leading up to the blowout was a contributing cause of the blowout.

BP's failure to place cement on top of the wiper plug was a contributing cause of the blowout.

BP's decision to use a float collar that was not sufficiently debris-tolerant was a possible contributing cause of the blowout.

BP's decision to set casing in the production interval with known drilling margin limits at total depth was a possible contributing cause of the blowout.

The fact that the *Deepwater Horizon* crew members did not have available to them accurate and reliable flow-line sensors during cementing operations in order to determine whether they were obtaining full returns was a possible contributing cause of the blowout.

Various decisions by BP and Halliburton with respect to planning and conducting the Macondo production casing cement job were possible contributing causes of the blowout.

The failure of BP's well site leaders and the Transocean *Deepwater Horizon* rig crew to recognize the risks associated with cementing operations problems that occurred between April 19 and April 20 was a possible contributing cause of the blowout.

#### ***B. Flow Path***

The Panel concluded that hydrocarbon flow during the blowout occurred through the 9-7/8 x 7 inch production casing from the shoe track as a result of float collar and shoe track failure.

#### ***C. Temporary Abandonment, Kick Detection, and Emergency Response***

The failure of the *Deepwater Horizon* crew (including BP, Transocean, and Sperry-Sun personnel) to detect the influx of hydrocarbons until the hydrocarbons were above the BOP stack was a cause of the well control failure.

The *Deepwater Horizon* crew's (BP and Transocean) collective misinterpretation of the negative tests was a cause of the well control failure.

The *Deepwater Horizon* crew's inability to accurately monitor pit levels while conducting simultaneous operations during the critical negative test was a contributing cause of the kick detection failure.

BP's failure to perform an incident investigation into the March 8, 2010 well control event and delayed kick detection was a possible contributing cause to the April 20, 2010 kick detection failure.



BP's failure to inform the parties operating on its behalf of all known risks associated with the Macondo well production casing cement job was a possible contributing cause of the kick detection failure.

BP's use of the lost circulation material pills as a spacer in the Macondo well, which likely affected the crew's ability to conduct an accurate negative test on the kill line, was a possible contributing cause of the kick detection failure.

The overall complacency of the *Deepwater Horizon* crew was a possible contributing cause of the kick detection failure.

Mark Hafle's failure to investigate or resolve the negative test anomalies noted by Donald Vidrine was a possible contributing cause of the kick detection failure.

The failure of the well site leaders to communicate well-related issues with the managers onboard the *Deepwater Horizon* was a possible contributing cause of the kick detection failure.

BP's failure to get complete and final negative test procedures to the rig in a timely fashion was a possible contributing cause of the kick detection failure.

The *Deepwater Horizon* crew's hesitance to shut-in the BOP immediately was a possible contributing cause of the kick detection failure.

BP's failure to conduct the first of the two negative tests was a possible contributing cause of the kick detection failure.

The rig crew's decision to bypass the Sperry-Sun flow meter while pumping the spacer overboard was a possible contributing cause of the kick detection failure.

The failure of BP's and Transocean's well control training and MMS requirements to address situations, such as negative tests and displacement operations, was a possible contributing cause of the well control failure.

The decision to use the mud gas separator during the well control event was a contributing cause of the response failure.

The ambiguity within the Transocean well control manual on when to use the diverter and not the mud gas separator was a contributing cause of the response failure.

The failure of the personnel on the *Deepwater Horizon* bridge monitoring the gas alarms to notify the *Deepwater Horizon* crew in the engine control room about the alarms so that they could take actions to shut down the engines was a contributing cause of the response failure.

The rig floor crew's inability to determine the location of the kick in relation to the BOP and the volume of hydrocarbons coming to the rig in a matter of seconds was a possible contributing cause of the response failure.

The rig crew's failure to initiate the emergency disconnect system until after the hydrocarbons were had risen above the BOP stack was a possible contributing cause of the response failure.

The "inhibited" general alarm system was a possible contributing cause of the response failure.

Transocean's failure to train the marine crew to handle serious blowout events was a possible contributing cause of the response failure.

#### ***D. Ignition Source***

The most probable ignition source was either engine room number 3 or engine room number 6.

The catastrophic failure of the mud gas separator created a possible ignition source with the gas plume released onto the rig from the well.

The location of the air intakes for the number 3 and number 6 engine rooms was a contributing cause of the *Deepwater Horizon* explosion.

The failure of the over-speed devices to initiate shutdown of the engines was a contributing cause of the *Deepwater Horizon* explosion.

Fleytas' failure to instruct the *Deepwater Horizon* engine room crew to initiate the emergency shutdown sequence after receiving 20 gas alarms

indicating the highest level of gas concentration was a contributing cause in the *Deepwater Horizon* explosion.

The classification of engine rooms number 3 and number 6 as non-classified areas was a possible contributing cause of the *Deepwater Horizon* explosion.

The failure to identify the risks associated with locating the air intake of engine room 3 in close proximity to the drill floor was a possible contributing cause of the *Deepwater Horizon* explosion.

The absence of emergency shutdown devices that could be automatically triggered in response to high gas levels on the rig was a possible contributing cause of the *Deepwater Horizon* explosion.

The failure of ABS and Transocean to document which devices were tested to ensure all devices are tested is a possible contributing cause of the *Deepwater Horizon* explosion.

The DP MODU operating philosophy when considering the performance of an Emergency Shutdown (ESD) is a possible contributing cause of the *Deepwater Horizon* explosion.

#### ***E. Blowout Preventer***

The Panel concluded that the failure of the BOP to shear the drill pipe and seal the wellbore was caused by the physical location of the drill pipe near the inside wall of the wellbore, which was outside the blind shear ram cutting surface during activation on April 20 or April 22.

The elastic buckling of the drill pipe forced the drill pipe to the side of the wellbore and outside of the BSR cutting surface, and was a contributing cause of the BOP failure.

The forces generated by the flow from the well and/or forces generated by the weight of the drill pipe led to the elastic buckling of the drill pipe and was a possible contributing cause of the BOP failure.

## F. *Company Practices*

The failure of the crew to stop work on the *Deepwater Horizon* after encountering multiple hazards and warnings was a contributing cause of the Macondo blowout.

BP's failure to fully assess the risks associated with a number of operational decisions leading up to the blowout was a contributing cause of the Macondo blowout.

BP's cost or time saving decisions without considering contingencies and mitigation were contributing causes of the Macondo blowout.

BP's failure to ensure all risks associated with operations on the *Deepwater Horizon* were as low as reasonably practicable was a contributing cause of the Macondo blowout.

BP's failure to have full supervision and accountability over the activities associated with the *Deepwater Horizon* was a contributing cause of the Macondo blowout.

BP's failure to document, evaluate, approve, and communicate changes associated with *Deepwater Horizon* personnel and operations was a possible contributing cause of the Macondo blowout.

The failure of BP and Transocean to ensure they had a common, integrated approach to well control was a possible contributing cause of the Macondo blowout.

The failure of the current Subpart O rule to identify (by definition) personnel who need to be trained in well control operations, specifically in kick detection, was a possible contributing cause of the Macondo blowout.

## XVIII. Conclusion

As detailed in this Report, the blowout at the Macondo well on April 20, 2010 was the result of a series of decisions that increased risk and a number of actions that failed to fully consider or mitigate those risks. While it is not possible to discern which precise combination of these decisions and actions set the blowout in motion, it is clear that increased vigilance and awareness by BP, Transocean and Halliburton personnel at critical junctures during operations at the Macondo well would have reduced the likelihood of the blowout occurring.

BP well designers set the casing in a location that created additional risks of hydrocarbon influx. Even knowing this, BP did not set additional cement or mechanical barriers in the well. BP made two additional significant decisions that further increased risks – first, it decided to have the *Deepwater Horizon* crew install a lock-down sleeve as part of the temporary abandonment procedure. Second, BP decided to use a lost circulation material as spacer, which risked clogging lines used for well integrity tests.

BP personnel and Transocean personnel failed to conduct an accurate negative test to assess the integrity of the production casing cement job. The *Deepwater Horizon* rig crew, therefore, performed temporary abandonment procedures while unaware of the failed cement job beneath them and the looming influx of hydrocarbons. Unfortunately, the rig crew then limited its kick detection abilities by deciding to bypass the Sperry Sun flow meter when displacing fluid from the well overboard.

The *Deepwater Horizon* rig crew missed signs of a kick and thus was delayed in reacting to the well control situation. Once the flow reached the rig floor, the crew closed the upper annular and upper variable bore ram and diverted the flow to the mud gas separator. The mud gas separator could not handle the volume of the blowout and explosions followed. Additionally, forensic analysis by DNV strongly suggests that by the time a crew member on the bridge activated the emergency disconnect system, the explosions had damaged the *Deepwater Horizon's* multiplex cable and hydraulic lines, which rendered inoperable the BOP stack's blind shear rams.

The force of the blowout, and possibly the force from drill pipe in the riser, buckled the drill pipe and placed it in a position where it could not be completely sheared by the blind shear ram blades. As a result, the blind shear

ram, when activated on either April 20 or April 22, could not shear the drill pipe and seal the wellbore. Flow from the Macondo well continued for 87 days after the blowout, spewing almost 5 million barrels of oil into the Gulf of Mexico.

In the following section of this Report, the Panel makes recommendations to improve the safety of offshore well operations. Recommended changes to regulatory requirements and oversight are made in the following areas: well design (particularly for high flow potential wells), well integrity testing, kick detection and response, rig configuration, blowout preventers, and remotely-operated vehicles.

## **XIX. Recommendations**

### **A. Well Recommendations**

1. The Agency should consider promulgating regulations that require the negative pressure testing of wells where the wellbore will be exposed to negative pressure conditions, such as when the BOP and riser are disconnected from the wellhead during permanent or temporary abandonment procedures. All subsea wells will experience a negative pressure condition when the BOP and riser are disconnected from the wellhead at either temporary or permanent abandonment time. While operations are being conducted on a well, the mud weight exerted on the formation is from the rig to the formation. Prior to unlatching the BOP, the mud in the riser is displaced with seawater in preparation of the rig to move off of location. This reduces the effective mud weight on the formation should a cement plug not set properly.<sup>472</sup> Had the *Deepwater Horizon* crew interpreted the negative test properly, the blowout may have been averted.
2. The Agency should consider incorporating in the Code of Federal Regulation (CFR) parts of API Recommended Practice (RP) 65, parts 1 and 2; The Agency should also consider supplementing the CFR to require compliance with specific API RP 65 requirements relating to among other things: a minimum hole diameter of 3.0 inches greater than the casing outer diameter; rathole mud density greater than cement; and mud conditioning volume greater than one annular volume. Currently, the CFR only requires a designated operator to provide a written statement on how it evaluated the best practices included in API RP 65.<sup>473</sup>
3. The Agency should research and consider, with a Notice to Lessees (NTL), defining the term “safe drilling margin(s)” in 30 CFR § 250.414(c), which refers to “[p]lanned safe drilling margin between proposed drilling fluid weights and the estimated pore pressures.” The definition should be expanded to encompass pore pressure, fracture gradient and mud weight. This expanded definition would be beneficial to BOEMRE and industry.

---

<sup>472</sup> This requirement was incorporated into the regulations with the interim final rule effective October 14, 2010.

<sup>473</sup> API 65 Part 2 was incorporated into the regulations with the interim final rule effective December 2010. This recommendation is to incorporate specifics within the regulations.

4. The Agency should consider promulgating regulations that require at least two barriers (one mechanical and one cement barrier) for a well that is undergoing temporary abandonment procedures.<sup>474</sup> As seen in this event the only barrier between the rig and the formation was a cement plug in the shoe track. Having a cement plug and an additional mechanical barrier would add an increased safety factor. While the Macondo well did have dual float valves, the Panel does not believe that float valves should be considered a mechanical barrier.<sup>475</sup>
5. The Agency should consider revising 30 CFR § 250.420(b)(3), which is included in the Interim Final Rule, to clarify that a float collar/valve is not to be considered to be a “mechanical barrier.” Float collars are designed to prevent the cement from u-tubing back into the work string; they are not designed to keep the formation pressures from coming up the wellbore. A dual float valve was used in the Macondo well. Clarifying the limitations of the float collar would prevent operators from relying on a device not designed specifically for pressure containment.<sup>476</sup>
6. The Agency should research and consider defining “lost returns,” “partial returns,” “full returns,” and “cement volume margin” within 30 CFR § 250.428. As seen in this event, lost returns played a large role in accurately determining hole stability and cement placement. However, the regulations do not define what is considered lost returns.

***B. Kick Detection and Response Recommendations***

1. The Agency should consider issuing a Safety Alert similar to Safety Alert 284 that addresses how the movement of fluid across the rig can limit the monitoring capabilities of rig personnel. As discussed in the Report, the multiple simultaneous operations involving fluid movement that were

---

<sup>474</sup> This recommendation was incorporated into the regulations with the interim final rule effective October 14, 2010.

<sup>475</sup> This recommendation was incorporated into the regulations with the interim final rule effective October 14, 2010.

<sup>476</sup> 30 CFR § 250.420 was revised with the interim final rule to require two barriers. This revision allows for the use of a dual float valve or one float valve and a mechanical barrier in addition to the cement. The Panel recommends that the agency should not allow the use of float valves as a mechanical barrier.



underway on the *Deepwater Horizon* prior to the blowout increased the difficulty of monitoring the wellbore.

2. The Agency should consider researching what meter accuracy is acceptable, as well as the placement of flow meters for the purpose of kick detection. Flow meters are accurate within 5-10%. Placement of these meters is critical so that the well can be accurately monitored and the vessel motion effect minimized.
3. The Agency should consider revising the incident reporting rule at 30 CFR § 250.188 to capture well kick incidents, similar to the March 8, 2010, Macondo well control event. Under current regulations, operators are only required to report “losses of well control” and are not required to report “well control” events such as kicks. The reporting of these events would allow the Agency to track them and evaluate trends that may indicate problems with a specific operator or contractor.
4. The Agency should consider working with industry to develop a standardized negative test procedure with interpretation guidance. As discussed in this Report, BP considered several negative test procedures without specific interpretation guidance. If interpretation guidance had been provided to the rig crew, the early signals of the well flowing may have been detected and the blowout averted.
5. The Agency should consider researching the effect of water depth on kick detection and response times in comparison to shallow water. Prompt kick detection is critical in deepwater operations with a subsea BOP stack. It is imperative that the rig crew detect well flow before the hydrocarbons rise above the BOP stack. If the kick is not detected until after the hydrocarbons rise above the BOP stack, then well control response options are severely limited and the risks of a blowout are significant.
6. The Agency should consider promulgating a regulation at 30 CFR § 250.416 that allows for the limited use of mud gas separator (MGS) systems. The Agency should consider including the requirements in API RP 96A in this regulation. MGS systems are designed to circulate out kicks in a controlled manner but are not designed to handle a large volume of uncontrolled flow. Operators must have procedures in place to guide the rig crew’s use of the MGS systems, and rig crews must be

trained on these procedures. In particular, rig crews need guidance on when to divert the flow overboard.

7. The Agency should review its procedures for analyzing the well activity reports to determine if the operator is accurately reporting significant anomalies (e.g., ballooning, lost returns, wellbore integrity failures). Currently, the requirements for the well activity reports include reporting of significant well events including, for example, lost returns, kick occurrence, and wellbore integrity failure. Under current Agency procedures, the engineer reviews the current approved procedure and compares it to the well activity report to ensure that the operator is complying with the approved permit.
8. The Agency should clarify the wellbore monitoring regulations contained in 30 CFR § 250.401(c) to address potential kick detection failures, like the ones that occurred at the Macondo well. This provision currently states that an operator should “[e]nsure that the toolpusher, operator’s representative, or a member of the drilling crew maintain continuous surveillance on the rig floor from the beginning of drilling operations until the well is completed or abandoned, unless you have secured the well with blowout preventers (“BOPs”), bridge plugs, cement plugs, or packers.” The Agency should clarify the meaning of the term “member of the drilling crew,” which is too broad and does not address specific requirements for surveillance of the well. The Agency should also clarify the meaning of the phrase “secured the well,” which does not address how the effectiveness of different cement barriers should be evaluated and monitored.

### *C. Ignition Source Recommendations*

1. The Agency should consider including in the Safety Alert discussions on design considerations of existing and planned air intake locations, operating philosophy when conducting design hazard analyses of Mobile Offshore Drilling Units (MODUs), inspection and testing documentation of all safety devices for engine shutdown, and performance of site-specific safety analyses of safety devices to ensure that systems align with operating philosophy.

2. The Agency should consider conducting unannounced inspections of all engine compartment air intake locations for all MODUs operating on the OCS to determine the extent of possible problems.
3. The Agency should perform an audit of mud gas separator venting systems for all MODUs operating on the OCS to ensure that adequate procedures are in place for proper use.
4. The Agency should consider working with the United States Coast Guard to evaluate potential regulatory reforms regarding air intake locations and the inspection and documentation of engine over-speed devices.

#### *D. Blowout Preventer Recommendations*

1. The Agency should evaluate research on BOP stack sequencing and centralization and should consider including in the Safety Alert a recommendation to lessees using a subsea BOP stack to centralize the drill pipe by means other than the annular preventer prior to activating the blind shear ram (BSR).
2. The Agency should consider promulgating regulations that require operators/contractors to have the capability to monitor the SEM battery(s) from the drilling rig. The SEM battery, as described in this Report, is very important for the activation of the automatic mode function (AMF/deadman) system. If the battery is weak, the system may not function as it was designed. Having the capability to monitor the SEM battery status from the rig would help ensure sufficient battery power exists to execute the system.
3. The Agency should consider researching the design options on MODUs that could protect MUX lines during an explosion incident. As the Report indicated, the initial explosions most likely damaged or destroyed the MUX lines, thus rendering the rig BOP control system inoperable. Had the system remained intact and operable, personnel may have been able to activate any BOP function sequence.
4. The Agency should consider researching the standardization of Remote Operating Vehicle (ROV) intervention panels, ROV intervention capabilities, and maximum closing times when using an ROV. On the *Deepwater Horizon*, numerous attempts were made to activate the BOP

using multiple ROVs. During these attempts, it was discovered that the ROV pump outputs were incapable of generating the volume needed to shift shuttle valves and activate the BOP functions. In sum, the ROV's pumps did not have the same pressure and fluid flow as the accumulator system that typically operates the BOP stack. Additionally, the ROVs were not always equipped with the necessary hot stabs needed to connect to the rig-specific BOP stack. Further, the ram closing times are significantly extended when using an ROV, creating the opportunity for ram erosion due to the uncontrolled flow of wellbore fluids and solids across the cutting and sealing surfaces of the ram blocks.

5. The Agency should consider researching the effects of a flowing well on the ability of a subsea BOP to shear pipe.
6. The Agency should consider researching a blind shear ram design that incorporates an improved pipe-centering shear ram.

#### *E. Regulatory Agency Recommendations*

1. The Agency should consider revising 30 CFR § 250.443 (g) to refer to “[a] wellhead assembly with a rated working pressure that exceeds the maximum anticipated *wellhead pressure*,” rather than “*surface pressure*,” as the regulation currently reads.
2. The Agency should consider revising the regulations at 30 CFR § 250.450(e) to define BOP testing “problems or irregularities.” BP’s daily operations reports noted that a pilot leak existed on one of the control pods over the course of 17 days. This leak existed during a time when the required BOP function and pressure testing occurred. Operators should be required to report irregularities, such as this type of leak, to the Agency.
3. The Agency should consider defining the term “properly functioning” in 30 CFR § 250.451(d), which states, in part, that if the lessee encounters a BOP control station or pod that does not function properly, it must “[s]uspend further drilling operations until that station or pod is operable.” The Agency should also consider defining the term “proper operation” under 30 CFR § 250.442(d), which states, “[t]he BOP system must include an operable dual-pod control system to ensure proper and independent operations of the BOP system.” As indicated in this Report,

there were BOP control system hydraulic leaks were noted in the daily operations report; however, they did not impede the closing ability of the annular or ram preventers. These leaks did require the placement of the BOP controls into the “block/neutral/vent” position in order to stop or slow the hydraulic leak. The Agency needs to determine if a pod with hydraulic leaks of this nature is an “operable pod” and/or is “function[ing] properly.”

4. The Agency should consider promulgating regulations that would require designated operators to report leaks associated with BOP control systems on the IADC daily report, in the well activity report, and to the district drilling engineer. This would ensure that the Agency is aware of the leak and could either require the operator to suspend operations and fix the leak or determine that the leak will not affect the operation of the BOP system and allow operations to continue.
5. The Agency should consider revising the definition of “well control” at 30 CFR § 250.1500 to read as follows: “Well control means drilling, well completion, well workover, and well servicing operations. It includes measures, practices, procedures and equipment, such as fluid flow monitoring, to ensure safe, accident-free, and pollution-free drilling, completion, and workover operations as well as the installation, repair, maintenance, and operation of surface and subsea well control equipment.” This revision would establish minimum expectations for who should be trained for their roles in monitoring and maintaining well control at all times. This new definition would encompass mudloggers as well as subsea engineers and anyone who has the responsibility for monitoring the well and/or maintaining the well control equipment. As discussed in the Report, the mudlogger played a critical role in monitoring the well along with the driller and assistant driller. BP, however, did not identify the mudlogger as a person needing well control training or a person responsible for monitoring the well for kick detection.
6. The Agency should consider expanding 30 CFR § 250.446 to include documentation and record keeping requirements for major (3-5 year) inspections as required by BOEMRE’s adoption of API RP 53, which identifies what major inspections and maintenance should be performed. However, API RP 53 does not indicate the necessary records needed to document that the major inspections were performed. This recordkeeping

would allow BOEMRE inspectors to review the major BOP inspection records to ensure they were performed as required.

7. The Agency should consider researching the best BOP stack configuration to minimize unsupported pipe in order to reduce the likelihood of elastic buckling of drill pipe.
8. The Agency should consider researching the need to require third-party surveys of the drilling packages on rigs operating on the OCS.
9. The Agency should consider researching the need for a complete independent, acoustically controlled system for subsea BOPs. This would eliminate the situation which occurred in this event where the MUX lines seemed to be damaged in the explosion and rendered the surface operation of the BOP inoperative. Having a complete independent control system would add an additional safeguard for operating the BOP stack.
10. The Agency should consider researching the need for a completely independent BOP system (short stack) in lieu of, or in addition to, the independent control system discussed in Recommendation 9. This gives the rig a truly independent, redundant, and robust system – unlike an acoustic system or any other secondary system. The *Deepwater Horizon* BOP stack had redundant elements, but these elements relied upon a number of the same components to function. A completely independent BOP control system provides true redundancy and robustness.
11. The Agency should consider promulgating regulations that would require real-time, remote capture of BOP function data. This would be beneficial in post-accident source control and subsequent investigations. Having the data that show which rams have been activated would help analyze intervention options. During the Macondo source control response and ROV intervention attempts, BP and Transocean did not know which rams may have been activated and critical time was spent trying to function a ram that had already been activated.

#### ***F. OCS Companies' Practices Recommendations***

The Agency should consider working with industry organizations to revisit the core well control training curriculum used by most companies and

training providers. At a minimum, well control training should encompass the following additional subjects:

1. Understanding the different options in deepwater well control when working from either a moored MODU or a dynamically positioned MODU;
2. The importance of fluid flow monitoring and early kick detection in deepwater wells;
3. Wellbore anomalies/hazards recognition and mitigations;
4. Recognition of limited well control options when wellbore fluids are detected above the BOP stack;
5. Use of the diverter and limited use of the mud-gas separator in a well control event; and
6. Incorporation of the emergency disconnect function into well control options. The Panel found that by the time the hydrocarbons reached the rig floor it might have been too late to attempt to control the flow. A better option in these cases may be to, in these cases, immediately activate the emergency disconnect function to disconnect from the well and stop further hydrocarbon flow.

## **Dedication**

---

On April 20, 2010, eleven people lost their lives onboard the Transocean *Deepwater Horizon*. The members of this Panel investigation team dedicate this Report to the memory of the following individuals:

Jason Christopher Anderson

Aaron Dale Burkeen

Donald Neal Clark

Stephen Ray Curtis

Gordon Lewis Jones

Roy Wyatt Kemp

Karl Dale Kleppinger, Jr.

Keith Blair Manuel

Dewey Allen Revette

Shane Michael Roshto

Adam Taylor Weise

With our findings and recommendations, we hope to improve offshore safety and prevent the reoccurrence of a tragic event like the Macondo blowout.



## Acknowledgement

---

With the support of the crew of the *Damon Bankston* and the *Ramblin Wreck*, 115 survivors were able to evacuate the *Deepwater Horizon* and be immediately rescued without further incident.

If the aforementioned crews did not quickly direct the search and rescue mission, assist in muster, provide changes of clothes, and coordinate medical attention and transfer of injured personnel, the death toll could have been higher.

The *Damon Bankston* and *Ramblin Wreck* crews displayed valor, leadership, and empathy towards their fellow mariners onboard the *Deepwater Horizon* at a time of peril. The well-being of the 115 survivors is directly attributable to their actions.

Further, BOEMRE recognizes the efforts of crews within the vicinity of MC 252 in responding to the *Deepwater Horizon* blowout. These individuals were the first responders on the scene and provided admirable assistance to their fellow offshore employees.

|                          |                      |                               |
|--------------------------|----------------------|-------------------------------|
| <i>Alice G. McCall</i>   | <i>Joe Griffin</i>   | <i>Ocean Intervention III</i> |
| <i>Bee sting</i>         | <i>Katrina Fagan</i> | <i>Pat Tillman</i>            |
| <i>Boa Sub C</i>         | <i>Kobe Chouest</i>  | <i>Reliance</i>               |
| <i>C Express</i>         | <i>Laney Chouest</i> | <i>Resolve Pioneer</i>        |
| <i>C. Enforcer</i>       | <i>Max Chouest</i>   | <i>Sail Fish</i>              |
| <i>C-Pacer</i>           | <i>Miss Addison</i>  | <i>Sea Express</i>            |
| <i>Fast Cajun</i>        | <i>Monica Ann</i>    | <i>Seacor Lee</i>             |
| <i>Geo Searcher</i>      | <i>Sydney</i>        | <i>Seacor Vanguard</i>        |
| <i>Gloria B. Callais</i> | <i>MSC Familia</i>   | <i>Seacor Washington</i>      |
| <i>Gulf Princess</i>     | <i>Norbert</i>       |                               |